

---

NORTH ATLANTIC TREATY  
ORGANIZATION



AC/323(SCI-244)TP/571

SCIENCE AND TECHNOLOGY  
ORGANIZATION



[www.sto.nato.int](http://www.sto.nato.int)

---

**STO AGARDograph 300**  
**Flight Test Technique Series – Volume 29**

**AG-300-V29**

# **Aircraft/Stores Compatibility, Integration and Separation Testing**

(Essais de compatibilité, d'intégration et de  
séparation des emports sur aéronef)

This AGARDograph has been sponsored by the  
Systems Concepts and Integration Panel.

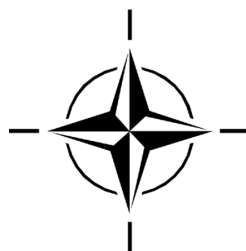

Published September 2014

---

*Distribution and Availability on Back Cover*





**STO AGARDograph 300**  
**Flight Test Technique Series – Volume 29**

**AG-300-V29**

# **Aircraft/Stores Compatibility, Integration and Separation Testing**

(Essais de compatibilité, d'intégration et de  
séparation des emports sur aéronef)

This AGARDograph has been sponsored by the  
Systems Concepts and Integration Panel.

---

# The NATO Science and Technology Organization

Science & Technology (S&T) in the NATO context is defined as the selective and rigorous generation and application of state-of-the-art, validated knowledge for defence and security purposes. S&T activities embrace scientific research, technology development, transition, application and field-testing, experimentation and a range of related scientific activities that include systems engineering, operational research and analysis, synthesis, integration and validation of knowledge derived through the scientific method.

In NATO, S&T is addressed using different business models, namely a collaborative business model where NATO provides a forum where NATO Nations and partner Nations elect to use their national resources to define, conduct and promote cooperative research and information exchange, and secondly an in-house delivery business model where S&T activities are conducted in a NATO dedicated executive body, having its own personnel, capabilities and infrastructure.

The mission of the NATO Science & Technology Organization (STO) is to help position the Nations' and NATO's S&T investments as a strategic enabler of the knowledge and technology advantage for the defence and security posture of NATO Nations and partner Nations, by conducting and promoting S&T activities that augment and leverage the capabilities and programmes of the Alliance, of the NATO Nations and the partner Nations, in support of NATO's objectives, and contributing to NATO's ability to enable and influence security and defence related capability development and threat mitigation in NATO Nations and partner Nations, in accordance with NATO policies.

The total spectrum of this collaborative effort is addressed by six Technical Panels who manage a wide range of scientific research activities, a Group specialising in modelling and simulation, plus a Committee dedicated to supporting the information management needs of the organization.

- AVT Applied Vehicle Technology Panel
- HFM Human Factors and Medicine Panel
- IST Information Systems Technology Panel
- NMSG NATO Modelling and Simulation Group
- SAS System Analysis and Studies Panel
- SCI Systems Concepts and Integration Panel
- SET Sensors and Electronics Technology Panel

These Panels and Group are the power-house of the collaborative model and are made up of national representatives as well as recognised world-class scientists, engineers and information specialists. In addition to providing critical technical oversight, they also provide a communication link to military users and other NATO bodies.

The scientific and technological work is carried out by Technical Teams, created under one or more of these eight bodies, for specific research activities which have a defined duration. These research activities can take a variety of forms, including Task Groups, Workshops, Symposia, Specialists' Meetings, Lecture Series and Technical Courses.

The content of this publication has been reproduced directly from material supplied by STO or the authors.

Published September 2014

Copyright © STO/NATO 2014  
All Rights Reserved

ISBN 978-92-837-0214-6

Single copies of this publication or of a part of it may be made for individual use only by those organisations or individuals in NATO Nations defined by the limitation notice printed on the front cover. The approval of the STO Information Management Systems Branch is required for more than one copy to be made or an extract included in another publication. Requests to do so should be sent to the address on the back cover.



---

## AGARDograph Series 160 & 300

Soon after its founding in 1952, the Advisory Group for Aerospace Research and Development (AGARD) recognized the need for a comprehensive publication on Flight Test Techniques and the associated instrumentation. Under the direction of the Flight Test Panel (later the Flight Vehicle Integration Panel, or FVP) a Flight Test Manual was published in the years 1954 to 1956. This original manual was prepared as four volumes: 1. Performance, 2. Stability and Control, 3. Instrumentation Catalog, and 4. Instrumentation Systems.

As a result of the advances in the field of flight test instrumentation, the Flight Test Instrumentation Group was formed in 1968 to update Volumes 3 and 4 of the Flight Test Manual by publication of the Flight Test Instrumentation Series, AGARDograph 160. In its published volumes AGARDograph 160 has covered recent developments in flight test instrumentation.

In 1978, it was decided that further specialist monographs should be published covering aspects of Volumes 1 and 2 of the original Flight Test Manual, including the flight testing of aircraft systems. In March 1981, the Flight Test Techniques Group (FTTG) was established to carry out this task and to continue the task of producing volumes in the Flight Test Instrumentation Series. The monographs of this new series (with the exception of AG-237 which was separately numbered) are being published as individually numbered volumes in AGARDograph 300. In 1993, the Flight Test Techniques Group was transformed into the Flight Test Editorial Committee (FTEC), thereby better reflecting its actual status within AGARD. Fortunately, the work on volumes could continue without being affected by this change.

An Annex at the end of each volume in both the AGARDograph 160 and AGARDograph 300 series lists the volumes that have been published in the Flight Test Instrumentation Series (AG 160) and the Flight Test Techniques Series (AG 300) plus the volumes that were in preparation at that time.

---

# Aircraft/Stores Compatibility, Integration and Separation Testing

## (STO-AG-300-V29)

### Executive Summary

This AGARDograph focuses on aircraft/stores compatibility, integration and separation testing issues that have to be executed during the integration of existing or newly developed store on to new or existing military aircraft.

One of the key differences between civilian and military aircraft is that many military aircraft have the ability to carry and release weapons. From the earliest days of aviation, when the pilot would drop simple bombs by hand, engineers have striven to develop the capability to accurately deliver weapons against targets reliably and safely.

However, the general understanding about the modern warfare is accustomed to focus on the missile and its capabilities mostly, considering that the weapon is a substantive system; the people involved in integration business are profoundly aware that the weapon and the launch aircraft forms a complex system together in which the performance of each individual component depends on the performance of the other one. The weapon can only achieve its designated performance, if the transactions on the launch aircraft required for the integration are done accurately.

The integration of weapons on aircraft requires evaluation of multiple topics related to different disciplines such as aerodynamics, structures, avionics/software maintenance, electro-magnetic interactions, flight test instrumentation, ground and flight tests. In addition to compatibility concerns, the release of a weapon creates issues such as the ability of the specific store to achieve safe separation and the ability of the aircraft structure to withstand the imparted loads during the ejection of store from pylon or launching phase in the presence of aircraft flow field. The number of subjects to cover is increased when the requirements for all the phases of integration process are considered. The execution of integration activities in a correct and complete manner is the solution of these concerns.

This document discussed the importance, order and ways of different test techniques for aircraft/weapon compatibility, integration and release issues. Moreover, defined expected minimum report contents that today's weapon systems test organizations require. Defining the engineering data package requirements, it also provided guidance to ensure the requirements for airworthiness are fulfilled.

# Essais de compatibilité, d'intégration et de séparation des emports sur aéronef

## (STO-AG-300-V29)

### Synthèse

Le présent AGARDograph porte sur la compatibilité entre les aéronefs et les emports, les essais d'intégration et de séparation qui doivent être réalisés pendant l'intégration d'une arme existante ou nouvelle sur les aéronefs militaires nouveaux ou existants.

L'une des différences essentielles entre les aéronefs civils et militaires est qu'un grand nombre d'aéronefs militaires ont la capacité de transporter et délivrer des armes. Dès les débuts de l'aviation, alors que les pilotes larguaient encore de simples bombes à la main, les ingénieurs ont cherché à développer des moyens pour projeter précisément des armes sur des objectifs de manière fiable et sûre.

Cependant, la guerre moderne a pris l'habitude de se concentrer principalement sur le missile et ses capacités, en considérant que l'arme est un système important. Ceux qui travaillent dans le domaine de l'intégration sont pleinement conscients que l'arme et l'aéronef qui la délivre forment un système complexe, dans lequel le fonctionnement de chacun dépend de celui de l'autre. L'arme ne peut fonctionner comme prévu que si les opérations nécessaires à l'intégration de l'arme avec l'aéronef de lancement sont minutieusement effectuées.

L'intégration des armes dans les aéronefs requiert l'évaluation de multiples sujets liés à différentes disciplines telles que l'aérodynamique, les structures, l'avionique / la maintenance des logiciels, les interactions électromagnétiques, l'instrumentation d'essais en vol, les essais au sol et en vol. Outre la compatibilité, la libération d'une arme crée des problèmes comme la capacité de l'emport en question à réaliser une séparation en toute sécurité et la capacité de la structure de l'aéronef à supporter les charges infligées pendant l'éjection de l'arme depuis le pylône ou la phase de lancement en présence dans le contexte aérodynamique de l'aéronef. Le nombre de sujets à traiter est plus grand lorsque l'on tient compte de toutes les phases du processus d'intégration. La solution consiste à exécuter les activités d'intégration d'une manière correcte et complète.

Ce document traite de l'importance, de l'ordre et des différentes techniques d'essai de compatibilité entre l'aéronef et l'arme, de l'intégration et des questions de séparation. Il définit de plus le contenu minimal que les organismes actuels d'essais des systèmes d'arme exigent dans les rapports. En définissant les exigences du dossier de conception, le présent document donne également des conseils pour assurer le respect des exigences en termes de navigabilité.

## Acknowledgements

After working for many years on flight test instrumentation/techniques, the opportunity to prepare a document that covered every aspect of aircraft/stores compatibility, integration and separation testing issues was a welcome undertaking. The AGARDograph entitled “Introduction to Flight Test Engineering (AGARD Flight Test Techniques Series Vol. 14)” written by Mr. F.N. Stoliker was the inspiration for this study – the efforts of Mr. F.N. Stoliker truly deserve appreciation and compliment.

The integration of weapons on aircraft requires different disciplines such as aerodynamics, structures, avionics/ software maintenance, electro-magnetic interactions, flight test instrumentation, ground and flight tests. For this reason, this document was supported by many contributors. Acknowledgement is given to the contributors, whose guidance and invaluable assistance has helped the author during the preparing period of the document: colleagues at Technology and Weapon System Development Directorate, especially Mr. Evren Özşahin, PhD, Mr. A. Turan Yeler, Mr. Önder Kırılı, PhD, Mr. T. Birtan Balevi, Mr. Tayfun Akpınar, Mrs. Şebnem Canikli Aykut and Mr. Nevzat Tarım, PhD. The author also gratefully acknowledges the precious support of Mr. Osman Başoğlu, PhD, Mr. Eren Topbaş, Mr. Selçuk Ataç and Mr. Koray Dayanç. The author would like to thank Mr. Lowry Wilson for his meritorious contribution to Chapter 6.

The author acknowledges the outstanding support of the editor, Ms. Kelly Edwards. For their invaluable review and improving feedbacks, special thanks go to SCI-172 members.

Finally, the author would like to thank the 1<sup>st</sup> Air Supply and Maintenance Center, Air Logistics Command HQ and Air Force Command HQ for the opportunity to be part of the NATO STO SCI-172 / SCI-244 activities.

## Foreword

In the literature, publications about aircraft/stores compatibility, integration and separation testing issues which this AGARDograph focused on, are limited. The document prepared with this motivation includes seven chapters from history to future developments and main steps of the integration/certification process.

In the first chapter, as mentioned above, background and history are covered starting from World War I when small air-to-ground bombs were dropped over the side of planes by the pilots. Today, after a century has passed since World War I, the integration efforts of weapon systems are performed using an aircraft/stores clearance and certification approach, and complex test and evaluation methods are conducted by highly capable military/civilian organizations.

Many different types of weapons can be found in the inventory of air forces around the world. These range from ballistic bombs, to smart bombs with control mechanisms that improve accuracy, to powered weapons having a greater range. Each weapon type requires different integration approaches during certification. In Chapter 2, a general overview of weapon systems and integration interfaces is introduced.

Chapter 3 focuses mainly on integration concepts including systems engineering which is an interdisciplinary, collaborative approach that derives, evolves and verifies a life-cycle balanced system solution which satisfies customer expectations and meets public acceptability. This chapter also covers the system models which allow capturing complexity at many different levels, including system-of-systems, system itself, sub-system, and component levels.

The aircraft/stores integration process requires analysis, simulations, ground and flight testing activities to be executed together. Details of the engineering work of the integration process are given in Chapter 4 which contains the general work flow of aircraft/stores compatibility tasks, avionics and mission planning integration, aero-mechanical and structural integration including analyses, ground and flight test issues and documentation.

Reporting is an essential part of aircraft/stores compatibility, integration and separation testing. In Chapter 5 entitled "Documentation", after introducing report types, reporting methods and the contents of commonly used ground and flight tests conducted during integration and certification efforts can be found.

Although carrier suitability testing includes both ground and flight testing, for this document, since military aircraft in naval service has specific requirements, it is only addressed briefly in Chapter 6 separately.

Finally, Chapter 7 aims to outline the future developments such as weaponization of unmanned systems which is the one of the most critical issue of today's and future's warfare, and universal armament interface that addresses the challenge for reducing the aircraft-weapon software integration costs.

## Preface



Col. Orhan Nadar is the expert of “Flight Test Engineering” and “Flight Test Management” for Turkish Air Force Command. He has been involved in “Avionics System Engineering”, “Test and Evaluation of Military Aircraft” and “External Stores Certification” for almost 30 years. Since 2009, he has been the Director of the Technology and Weapon System Development Directorate in Eskişehir, Turkey. He has been involved with the “Designing of Peculiar Avionics Test Systems”, “Development of Test Program Set for Modern Avionics Systems on the Automatic Test Equipment”, “Systems Engineering of Avionics Systems” and “Flight Test Instrumentation”. He has been involved in many international projects, on many aircraft including T-33 Shooting Star, CN-235 Persuader, T-37 Tweet, T-38 Talon, F-104 Starfighter, F-5 Freedom Fighter, F-4 Phantom, F-16 Fighting Falcon and F-35 Lightning II. He has also taken part in aircraft modernization projects, development and integration/certification of smart air-to-ground and air-to-air munitions and functional airborne pods programs. He has also represented the Turkish Air Force in NATO STO SCI-172 since 2008.

Col. Nadar received a Bachelor of Science degree in Electronics Engineering from Hacettepe University in Ankara, Turkey and a Bachelor of Business Administration degree in Management and Organization from Anatolian University in Eskişehir, Turkey.

# Table of Contents

	<b>Page</b>
<b>AGARDograph Series 160 &amp; 300</b>	<b>iii</b>
<b>Executive Summary</b>	<b>iv</b>
<b>Synthèse</b>	<b>v</b>
<b>Acknowledgements</b>	<b>vi</b>
<b>Foreword</b>	<b>vii</b>
<b>Preface</b>	<b>viii</b>
<b>List of Figures</b>	<b>xiii</b>
<b>List of Tables</b>	<b>xvi</b>
<b>List of Acronyms</b>	<b>xvii</b>
<b>Aeronautical Unit Designations – Aeronautical Item Identification Designators</b>	<b>xix</b>
<b>Glossary</b>	<b>xxi</b>
<b>SCI-244 Membership List</b>	<b>xxv</b>
<b>Chapter 1 – Background and History</b>	<b>1-1</b>
<b>Chapter 2 – General Overview of Weapon Systems and Integration Interfaces</b>	<b>2-1</b>
2.1 Weapon Designations	2-1
2.2 Un-Guided (Ballistic) Bombs	2-2
2.3 Guided (Smart) Bombs	2-5
2.4 Important Aircraft/Stores Interfaces	2-11
2.4.1 Stores Management System (SMS)	2-11
2.4.2 Weapon Interface Standard (MIL-STD-1760)	2-14
2.4.3 Armament Equipment	2-16
2.4.3.1 Launchers	2-17
2.4.3.2 Racks	2-17
2.4.3.3 Bomb Ejector Racks	2-18
2.4.3.4 Pneumatic Bomb Ejector Racks	2-18
2.4.3.5 Multiple Bomb Ejector Racks	2-19
<b>Chapter 3 – Integration Concept</b>	<b>3-1</b>
3.1 Systems Engineering During Integration Process	3-2
3.1.1 Fundamentals of Systems Engineering	3-3
3.1.2 Systems Engineering and Traditional Engineering Disciplines	3-4
3.1.3 Systems Engineering Fields	3-4
3.1.4 System Engineering Process	3-5
3.1.4.1 Functional Analysis/Allocation	3-6

3.1.4.2	Synthesis	3-6
3.1.4.3	Design	3-6
3.1.4.4	Design Verification	3-6
3.1.4.5	Systems Analysis and Control	3-6
3.1.4.6	Trade-Off Studies	3-7
3.1.4.7	Synthesis Trade-Off Studies	3-7
3.1.4.8	System/Cost Effectiveness Analysis	3-7
3.1.5	Risk Management	3-7
3.1.6	Configuration Management	3-7
3.1.7	Interface Management	3-8
3.1.8	Data Management	3-8
3.2	Managing Complexity with Models	3-8
3.2.1	The Waterfall Model	3-8
3.2.2	The V Development Model	3-9
3.2.3	The Spiral Model	3-10
<b>Chapter 4 – Engineering Work</b>		<b>4-1</b>
4.1	Aircraft/Stores Compatibility Work Flow	4-6
4.2	Avionics Integration	4-8
4.2.1	Systems Integration	4-8
4.2.2	Operational Flight Program Integration	4-8
4.2.2.1	The Software Requirements Analysis	4-10
4.2.2.2	Software Design Phase	4-11
4.2.2.3	Coding	4-13
4.2.2.4	Software Testing	4-14
4.2.2.5	Software Maintenance	4-15
4.2.2.6	Operational Flight Software Development Overview	4-15
4.2.2.7	Configuration Management	4-17
4.2.2.8	Systems Integration Laboratory Tests	4-17
4.3	Mission Planning System Integration	4-19
4.4	Aero-Mechanical and Structural Integration	4-19
4.4.1	Analysis	4-19
4.4.1.1	Physical Fit and Mechanical Interface Analysis	4-19
4.4.1.2	Aerodynamic Analysis	4-19
4.4.1.3	Environmental Analysis	4-22
4.4.1.4	Structural Integration Analysis	4-27
4.4.2	Ground Tests	4-29
4.4.2.1	Physical Fit and Functional Tests	4-29
4.4.2.2	Static Ejection Test	4-31
4.4.2.3	Ground Vibration Test (GVT) – “Big” Modal Test	4-32
4.4.2.4	Wind Tunnel Tests	4-37
4.4.2.5	Environmental Tests	4-42
4.4.3	Flight Tests	4-55
4.4.3.1	Flight Test Instrumentation and Planning	4-55
4.4.3.2	Flutter Tests	4-66
4.4.3.3	Environmental Effects Test	4-74



4.4.3.4	Flying Qualities Test	4-77
4.4.3.5	Performance and Drag Tests	4-77
4.4.3.6	Captive Flight Profile Tests	4-78
4.4.3.7	Employment Tests	4-79
4.4.3.8	Ballistics Test	4-80

## **Chapter 5 – Documentation 5-1**

5.1	Report Types	5-1
5.1.1	Data Report	5-1
5.1.2	Final Report	5-1
5.1.3	Compatibility Report or Airworthiness Qualification Report (for the Army)	5-2
5.2	Ground Test Reports	5-2
5.2.1	Fit Test Reports	5-2
5.2.2	Function Test Reports	5-2
5.2.3	Static Ejection Test Reports	5-2
5.2.4	Ground Vibration Test (GVT) – “Big” Modal Test Reports	5-3
5.2.5	Wind Tunnel Tests Reports	5-4
5.2.5.1	Effects of Aircraft on Captive Stores/Suspension Equipment Reports	5-4
5.2.5.2	Effects of Captive Stores/Suspension Equipment on Aircraft Reports	5-4
5.2.5.3	Aeroelastic Effects Test Reports	5-4
5.2.5.4	Store Separation Tests Reports	5-5
5.2.6	Environmental Tests Reports	5-5
5.2.6.1	Vibration Test Reports	5-5
5.2.6.2	Aeroacoustic Test Reports	5-6
5.2.6.3	HERO Reports	5-6
5.2.6.4	EMC/EMI Reports	5-7
5.2.6.5	Temperature Effects Reports	5-7
5.3	Flight Test Reports	5-7
5.3.1	In-Flight Loads Test Reports	5-7
5.3.1.1	Flutter Test Reports	5-7
5.3.2	Environmental Test Reports	5-8
5.3.2.1	Vibration Test Reports	5-8
5.3.2.2	Aeroacoustic Test Reports	5-9
5.3.2.3	Thermal Test Reports	5-10
5.3.2.4	EMC/EMI Test Reports	5-10
5.3.3	Flying Qualities	5-10
5.3.4	Performance and Drag Test Reports	5-10
5.3.5	Captive Flight Profile Test Reports	5-10
5.3.5.1	Handling Qualities Test Reports	5-10
5.3.5.2	Structural Integrity Test Reports	5-10
5.3.5.3	Endurance Test Reports	5-11
5.3.6	Employment Tests Reports	5-11
5.3.6.1	Release Test Reports	5-11
5.3.7	Jettison Test Reports	5-11

---

5.3.8	Ballistic Tests Reports	5-11
5.3.8.1	Weapon Free Stream Ballistics Test Reports	5-11
5.3.8.2	OFP Ballistic Test Reports	5-14
5.3.8.3	Separation Effects Test Reports	5-15
5.3.8.4	OFP Ballistic Verification Test Reports	5-15
<b>Chapter 6 – Shipboard Carrier Suitability Testing/Reporting</b>		<b>6-1</b>
6.1	Introduction	6-1
6.2	Basic CVS Catapult Launch and Arrested Landing Tests	6-2
<b>Chapter 7 – Future Developments</b>		<b>7-1</b>
7.1	Weaponization of Unmanned Air Systems	7-1
7.2	Universal Armaments Interface	7-1
<b>Chapter 8 – References</b>		<b>8-1</b>
<b>Annex A – AGARD and STO Flight Test Instrumentation and Flight Test Techniques Series</b>		<b>A-1</b>

## List of Figures

<b>Figure</b>		<b>Page</b>
Figure 1-1	Bomber A-24 (Used Between 1940 and 1944)	1-1
Figure 2-1	AGM on F-16 Aircraft	2-1
Figure 2-2	Designations for US Missile Systems	2-2
Figure 2-3	Munitions Designations for US Systems	2-2
Figure 2-4	F-111F Aircraft Releasing its Load of Mark 82 Retarded Bombs	2-3
Figure 2-5	Example of a Bomb Rack (MAU-12)	2-3
Figure 2-6	Seeker	2-5
Figure 2-7	Cross Section of a Thermal Battery	2-7
Figure 2-8	Efficiencies of Propulsion Alternatives Across the Mach Number	2-7
Figure 2-9	Launch Acceptability Region	2-9
Figure 2-10	Typical Aircraft LAR Display	2-10
Figure 2-11	Turbojet-Powered Cruise Missile	2-11
Figure 2-12	Simplified SMS Architecture	2-13
Figure 2-13	Weapon Timeline	2-16
Figure 2-14	BRU-12/A Aircraft Bomb Rack	2-17
Figure 2-15	Bomb Ejector Racks	2-18
Figure 2-16	A Pneumatic Bomb Ejection Rack	2-19
Figure 2-17	Multiple Ejector Rack Loaded Up with Three Air-to-Ground Munitions	2-20
Figure 2-18	BRU-61/A Pneumatic Multi-Stores Carriage System Installed on A/C	2-20
Figure 3-1	Systems Engineering in Context of Overall Project Management	3-4
Figure 3-2	Examples of Systems Engineering Fields	3-5
Figure 3-3	The System Engineering Process	3-5
Figure 3-4	The Waterfall Model in a Software Development Project	3-8
Figure 3-5	The V Development Model	3-9
Figure 3-6	The Spiral Model	3-10
Figure 4-1	Preliminary Design Process	4-6
Figure 4-2	Detail Design Process	4-7
Figure 4-3	Production / Integration Process	4-7
Figure 4-4	Test / Documentation Process	4-8
Figure 4-5	Systems Software Functional Requirements Process Flow	4-9
Figure 4-6	The Requirements Engineering Process	4-10
Figure 4-7	A General Model of the Design Process	4-12
Figure 4-8	An Input-Output Model of Program Testing	4-14

Figure 4-9	Operational Flight Software Development Process	4-16
Figure 4-10	A System Integration Laboratory	4-17
Figure 4-11	A Typical Data Monitoring and Real-Time Data Display Capability	4-18
Figure 4-12	Mission Planning System Interfaces	4-19
Figure 4-13	An Example to Flight Envelope	4-20
Figure 4-14	Separation Analyses Examples	4-21
Figure 4-15	Thermal Analysis of an Aircraft	4-22
Figure 4-16	An Example to Temperature Changes for a Flight Profile	4-22
Figure 4-17	An Example to Flight Envelope	4-23
Figure 4-18	Low Temperature Zones	4-24
Figure 4-19	High Temperature Zones	4-25
Figure 4-20	Instant Climb and Dive Maneuvers in Flight Envelope	4-25
Figure 4-21	Various Aeroelastic Problems	4-26
Figure 4-22	An Example to Power Spectral Density Analyses of Flight Acceleration Data	4-27
Figure 4-23	Forward and Aft Ejection Forces vs. Time for Ard-446/Ard-863 Cartridges and -4/-4 Orifice Setting for Store Weights from 100 to 4800 lbs	4-28
Figure 4-24	General Load Factor Envelope	4-29
Figure 4-25	Physical Fit Check	4-30
Figure 4-26	OFP Validation Test	4-31
Figure 4-27	Static Ejection Test	4-32
Figure 4-28	The Space Shuttle Enterprise Ground Vibration Test	4-34
Figure 4-29	Ground Vibration Testing of Munition Under Development	4-35
Figure 4-30	Wind Tunnel Testing Examples	4-38
Figure 4-31	CTS System	4-40
Figure 4-32	An Example of Low Temperature Test	4-42
Figure 4-33	An Example of Humidity Test	4-43
Figure 4-34	Various Transmitter and EW Antenna of A/C	4-50
Figure 4-35	Locations of Accelerometers	4-57
Figure 4-36	Camera Pod Used on F-16	4-58
Figure 4-37	Frontal Camera Adaptor, its Application and Rear Camera Adaptor on F-4	4-59
Figure 4-38	Rear Camera Adaptor and its Application Under the Fuselage of F-16	4-59
Figure 4-39	Camera Application Inside the Fuselage of F-16	4-60
Figure 4-40	Picture Taken from a High-Speed Camera	4-60
Figure 4-41	Mechanical Interface Designed for Implementation of FTI	4-61
Figure 4-42	A Mechanical Interface for the Accelerometer Used in F-16 External Fuel Tanks	4-61
Figure 4-43	Flight Test Instrumentation Equipment in F-16's Electronic Compartment	4-62
Figure 4-44	Flight Test Instrumentation Cabling on F-16 Wings	4-62
Figure 4-45	Camera Interfaces in the Cockpit of F-16	4-63
Figure 4-46	Flight Flutter Test on F-16 A/C for Newly Developed Munitions	4-67

---

Figure 4-47	Minimum Required Flutter Margin	4-68
Figure 4-48	Required Damping	4-68
Figure 4-49	Identification of Dynamic Characteristics	4-70
Figure 4-50	Flutter Test Procedures	4-72
Figure 4-51	Typical Flight Envelope of an Aircraft	4-76
Figure 7-1	UAI System Interface Description	7-2
Figure 7-2	Simple UAI Compliant LAR Database Generation Procedure	7-3

## List of Tables

<b>Table</b>		<b>Page</b>
Table 2-1	Designation Codes for US Missile Systems	2-2
Table 4-1	Wind Tunnel Data and Instrumentation Requirements	4-38
Table 4-2	Emission and Susceptibility Requirements	4-52
Table 4-3	Requirement Matrix	4-53
Table 4-4	Type of EMI/EMC Testing	4-54
Table 5-1	Ballistic Data Definitions	5-12
Table 5-2	Ballistic Data Title Page Format	5-14
Table 5-3	Ballistic Data Printout Format	5-14
Table 5-4	Data for OFP Ballistic Evaluation and Verification Tests	5-15
Table 6-1	Typical Catapult Launch Matrix	6-3
Table 6-2	Typical Arrested Landing Test Matrix	6-4
Table 7-1	Key Cost Drivers in Store Integration	7-1

## List of Acronyms

AAE	Airborne Armament Equipment
AFSEO	Air Force Seek Eagle Office
AGM	Air-to-Ground Missiles
AIM	Air Intercept Missiles
AUR	All-Up Round
BAL	Basic Aircraft Limits
BIT	Built-In Test
BR	Balance Realization
C.G.	Center of Gravity
CAL	Clear Aircraft Limits
CBU	Dump/Unguided Cluster Bombs
CCIP	Continually Calculated Impact Point
CDF	Configuration Data Files
CDS	Configuration Data Set
CEDP	Compatibility Engineering Data Package
CEP	Circle of Error Probable
CFD	Computational Fluid Dynamics
CFE	Contractor Furnished Equipment
CI	Configuration Item
CMA	Classical (or Experimental) Modal Analysis
CSC	Computer Software Component
CSU	Computer Software Units
CVA	Canonical Variety Analysis
CVS	Carrier Suitability Testing
DOF	Degree Of Freedom
DTC	Data Transfer Cartridge
E3	Electro-Magnetic Environment Effects
ECM	Electronic Countermeasure
EID	Electrically Initiated Devices
EM	Electro-Magnetic
EMA	Experimental Modal Analysis
EMC	Electro-Magnetic Compatibility
EMI	Electro-Magnetic Interference
ERU	Ejector Release Unit
ESM	Electronic Support Measure
FFT	Fast Fourier Transform
GFE	Government Furnished Equipment
GOLIS	Go Onto Location In Space
GOT	Go Onto Target
GP	Dump/Unguided General Purpose Bombs
GVT	Ground Vibration Testing

---

HERO	Hazards of Electromagnetic Radiation to Ordnance
IAM	Inertial Aided Munitions
ICD	Interface Control Document
ID	Identification
JMPS	Joint Mission Planning System
LAR	Launch Acceptability Region
LGB	Laser Guided Bombs
LOAL	Lock-On After Launch
LOBL	Lock-On Before Launch
LOS	Line Of Sight
MER	Multiple Ejector Racks
MFD	Multifunction Display
MTBF	Mean Time Between Failures
MTTF	Mean Time To-Failure
OFP	Operational Flight Program
OMA	Operational Modal Analysis
PBER	Pneumatic Bomb Ejector Racks
PGM	Precision Guided Munitions
RAM	Reliability, Availability and Maintainability
RIU	Remote Interface Unit
SCM	Software Configuration Management
SIL	System Integration Laboratory
SMS	Stores Management System
SSDP	Standard Source Data Package
STP	Software Test Plans
STR	Safe To Release
SWCDR	Software Critical Design Review
SWPDR	Software Preliminary Design Review
T&E	Test and Evaluation
TER	Triple Ejector Racks
TLE	Target Location Error (expressed in three dimensions: latitude, longitude and height)
TO	Technical Order
TOO	Target Of Opportunity
TSR	Two Sting Rig
UAI	Universal Armament Interface
UAS	Unmanned Air Systems
UPC	Unique Planning Component
V&V	Validation & Verification



# Aeronautical Unit Designations – Aeronautical Item Identification Designators

AI	Airborne Intercept
AD	Certain Adapting Items
BB	Explosive Items
BD	Simulated Bombs
BL	Bombs and Mines
BR	Bomb Racks and Shackles
BS	Munition Stabilizing and Retarding Devices
CB	End Item Cluster Bombs
CC	Actuator Cartridges
CD	Clustered Munitions (not end items)
CN	Miscellaneous Containers
DS	Target Detecting Devices
FM	Munitions Fuses
FS	Munitions Fuse Safety-Arming Device
FZ	Fuse-Related Items
GA	Aircraft Gun
GB	Guided Bombs
GP	Podded Guns
GU	Gun-related items / Miscellaneous Guns
KA	Munitions Clustering Hardware
KM	Kits
LA	Aircraft Installed Launchers
LK	Ammunition Links
LM	Ground Based Launchers
LU	Illumination Units
MA	Miscellaneous Armament Items
MD	Miscellaneous Simulated Munitions
MH	Munitions Handling Equipment
MJ	Munitions Countermeasures
ML	Miscellaneous Munitions
MT	Mounts
PA	Munitions Dispensing Devices, External
PD	Leaflet Dispenser
PG	Ammunition
PW	Internal Dispensers
RD	Dummy Rockets
RL	Rockets

---

SA	Gun-Bomb-Rocket Sights
SU	Stores Suspension and Release Items
TM	Miscellaneous Tanks
TT	Test Items
WD	Warheads
WT	Training Warheads

# Glossary

**Acceptable Separation:** Safe separation which meets pertinent operational criteria.

**Aircraft:** Any vehicle designed to be supported by air, being borne up either by the dynamic action of the air upon the services of the vehicle, or by its own buoyancy. The term includes fixed and moveable wing airplanes, helicopters, gliders, and airships, but excludes air-launched missiles.

**Aircraft Dispersion:** Aircraft errors contributing to ballistic error budget (sensor errors, on-board avionics errors, timing delays, fire control, variation in rack ejection forces, etc.).

**Aircraft Store:** Device intended for internal or external carriage and mounted on aircraft suspension and release equipment:

- Expendable store (missile, rocket, bomb, nuclear weapon, mine, torpedo, pyrotechnic device, sonobuoy, signal underwater sound device, etc.)
- Non-expendable store (not normally separated: fuel tank, electronics pod, gun pod, suspension rack, etc.)
- In this AGARDograph store determines mainly weapons due to the author's proficiencies.

**Aircraft/Stores Compatibility:** Ability of aircraft, stores, stores management systems, and suspension equipment to coexist without unacceptable aerodynamic, structural, electrical or functional characteristics under all expected flight and ground conditions.

**Airworthiness:** The ability of an aircraft, or other airborne equipment or system, to operate in flight and on ground without significant hazard to aircrew, ground-crew, passengers (where relevant) or to other third parties.

**Airworthiness Qualification (or certification of a store):** The primary purpose of the airworthiness qualification is to demonstrate that the air vehicle has the capability to function satisfactorily and safely when used within prescribed limits. The airworthiness qualification process will ensure that the store properly integrated into the air vehicle. Airworthiness qualification is defined as an analysis, design, test, and documentation process used to determine that an air vehicle system, subsystem, or component is airworthy. It is a progressive assessment process at the component, subsystem, and system levels to ensure that a system meets airworthiness criteria.

**Airworthiness Release:** A technical document that provides operating instructions and limitations, and maintenance information necessary for safe flight operation of an air vehicle systems, subsystem, and allied equipment. An airworthiness release is required prior to operating a new air vehicle system or a fielded system that has undergone any kind of modification.

**All-Up-Round (AUR):** Completely assembled store (mechanically and electrically) ready for installation on or in aircraft for purpose of carriage and employment.

**Asymmetrical Carriage:** Carriage of stores unlike in shape, physical properties, or number with reference to the aircraft plane of symmetry.

**Authorized Download:** Any configuration that results from the downloading of weapons in the normal employment sequence from an authorized configuration.

**Ballistics:** The science that deals with motion, behavior, appearance, or modification of missiles or other vehicles acted upon by propellants, wind, gravity, temperature, or any other modifying substance, condition, or force.

**Ballistic Accuracy Evaluation and Verification:** Flight testing process through which the accuracy of the ballistic portion of the aircraft Operational Flight Program (OFP) is determined.

**Ballistic Dispersion:** Weapon to weapon variation in free-stream ballistic flight path attributed to manufacturing tolerances (mass and physical properties, accidental misalignments during assembly or handling).

**Ballistic Trajectory:** The trajectory of a vehicle or weapon after the propulsive force is terminated and the body is acted upon only by gravity and aerodynamic drag.

**Best Preliminary Estimate:** All-inclusive estimate of resource requirements necessary for certification (time & money).

**Carriage:** Conveying of stores by aircraft under all ground and flight conditions.

**Circular Error Probable (CEP):** A measure of accuracy whose value is equal to the radius of a circle centered on the target or mean point of impact and contains 50 percent of the population impact points.

**Compatibility Engineering Data Package (CEDP):** A brief data package of the specific store having information about physical description, mass properties, functional description, interface, aerodynamic loads, Structural Analysis Reports, Environmental Analysis and Qualification Test Reports, Electro Magnetic Compatibility and Interference Data Reports.

**Conformal (or tangential) Carriage:** Stores to conform as closely as practical to external aircraft lines to reduce drag and obtain best overall aerodynamic shape.

**Critical Conditions:** Expected pertinent operational parameters encountered by an aircraft, stores, or combinations thereof, upon which the design or operational limits of the aircraft, stores or portions thereof are based.

**Degrade:** Any decomposition to a system that prevents or causes it to not perform in its intended manner.

**Dispense:** Intentional separation from airborne dispenser for employment.

**Dispersion:** Scattered pattern of hits around mean point of impact of bombs or projectiles dropped or fired under identical conditions.

**Dive Bombing:** In dive bombing the plane descends toward the target at an angle of 60 degrees or more, thus imparting considerable vertical velocity to the bomb at the moment of release. In a steep dive, with the bomb released at 2,000 to 6,000 feet, time of flight is short and air resistance, wind, and target motion are small.

**Ejection:** Separation of a store with the assistance of a force from a device, either external or internal to the store.

**Electromagnetic Environment Effects (E3):** The impact of the electromagnetic environment upon the operational capability equipment, systems, and platforms. It encompasses all electromagnetic disciplines, including electromagnetic compatibility, electromagnetic interference, electromagnetic vulnerability, electromagnetic pulse, hazards of electromagnetic radiation to personnel, ordinance and volatile materials, and natural phenomena effects of lightning, and precipitation static.

**Electromagnetic Interference (EMI):** Any electromagnetic disturbance, whether intentional or not, that interrupts, obstructs, or otherwise degrades or limits the effective performance of electronic or electrical equipment.

**Employment:** Use of a store for purpose and in manner for which designed.

**Failure Mode:** Malfunction of weapon components which must operate normally to ensure acceptable separation (autopilot actuation, fin employment).

**Fire:** Operation of a gun, gun pod or similar weapon.

**Flight Clearance:** Authorization for flight after appropriate engineering analysis to include determination of aircraft and store limits, and remarks for operation. The flight clearance specifies flight limits and remarks for operation for the loading configuration required on a specific aircraft, or group of aircraft, and remains valid only for a specified finite period of time for a specific user or group of users.

**Free Flight:** The movement or motion of a store, powered or unpowered, through the air after separation from an aircraft.

**Free-stream Ballistics:** A model of weapon flight path from the time that the weapon reaches steady state flight after release from the aircraft.

**Glide Bombing:** Glide bombing is similar to dive bombing except that the attack angle is less than 60 degrees. This technique is better adapted to fighter-type aircraft which tend to develop excessive speeds in steep dives.

**G-Jump:** Change in normal load factor as result of store release due to combined effects of ejection force, dynamic response and instantaneous aircraft gross weight decrease.

**Hung Store / Hang Fire:** Store which does not separate from aircraft when employed or jettisoned.

**Jettison (Selective versus Emergency):** Intentional separation, normally in a safe manner, for other than employment.

**Kalman Filtering:** A mathematical approach to linear filtering and prediction.

**Launch:** Intentional separation of self-propelled stores for employment.

**Mixed Load:** The simultaneous carriage or loading of two or more unlike stores on a given aircraft.

**Multiple Carriage:** Carriage of more than one store on suspension equipment (TER/MER).

**Operating Limitation:** Flight carriage, employment and jettison envelopes detailing acceptable airspeed, Mach, altitude, delivery angles, load factor (g), roll rate, wing sweep, speed brake operation, release modes and minimum release intervals for a specific aircraft/stores configuration.

**Pairs:** Simultaneous separation of stores from separate aircraft stations.

**Release:** Intentional separation of free-fall stores for employment.

**Ripple (or Train):** Separation of two or multiple stores in a given sequence at a specified interval.

**Safe Separation:** Separation without exceeding design limits of aircraft or stores, without damage, without contact, or without unacceptable adverse effects.

**Safe To Release (STR):** Stores ready for release.

**Salvo:** Simultaneous separation of stores from multiple aircraft stations.

**Separation:** Terminating of all physical contact between store, or portions thereof, and aircraft or suspensions equipment.

**Separation Effects:** A model of the weapon motion from the moment it is released until oscillations caused by the aircraft flow field are dampened.

**Single Carriage:** Carriage of only one store on any given station or pylon.

**Skip Bombing:** In skip bombing the plane usually attacks at less than 500 feet and the bomb is dropped so close to the target that computation is simple and accuracy high. If the target is a ship, the bomb is released to hit near the waterline just before the plane pulls up to pass over the target.

**Store:** Any device intended for internal or external carriage and mounted on aircraft suspension and release equipment, whether or not the item is intended to be separated in flight from the aircraft. Stores include missiles, rockets, bombs, nuclear weapons, mines, torpedoes, pyrotechnic devices, detachable fuel and spray tanks, line-source disseminators, dispensers, pods (refueling, thrust augmentation, gun, electronic-counter measures, etc.), targets, cargo-drop containers, and drones.

**Store Certification:** The determination of the extent to which a specific aircraft/stores combination is compatible and the formal publication of all information necessary for employment of the stores on the aircraft in the applicable technical and flight operations manuals.

**Standard Source Data Package (SSDP):**

- Munition Description
- Loading Procedures

**Submunition:** Any munition that, to perform its task, separates from a parent munition.

**Suspension Equipment:** Aircraft devices used for carriage, suspension, employment and jettison (racks, adapters, missile launchers, pylons, etc.).

**Symmetrical Carriage:** Arrangement of identical stores on either side of the plane of symmetry as related to given aircraft, suspension equipment or weapons bay.

**System Dispersion:** The total dispersion due to the weapon and the aircraft.

**Tandem Carriage:** Carriage of more than one store on suspension equipment such that one store is behind the other.

**Toss Bombing:** Toss bombing is a technique wherein the pilot dives directly at the target for a short time and then pulls out. The bomb is released automatically during pull-out, the pull-out maneuver giving the bomb additional forward velocity so that it is tossed above the original LOS and its trajectory intersects the original LOS at the target.

**T&E:** Test and Evaluation. T&E is the process by which a system is compared against technical or operational criteria through testing and the results are evaluated to assess performance against agreed criteria. T&E is usually conducted to assist in making engineering, programmatic or process decisions, and to reduce the risks associated with the outcome of those decisions. In control theory and management terms, T&E can be best thought of as the negative feedback loop on the capability life cycle management process.

**Validation:** The purpose of the Validation Process is to provide objective evidence that the services provided by a system when in use comply with stakeholders' requirements, achieving its intended use in its intended operational environment.

**Verification:** The purpose of the Verification Process is to confirm that the specified design requirements are fulfilled by the system.

**V&V:** Validation & Verification. The process of checking that a product, service, or system meets specifications and that it fulfills its intended purpose.

## SCI-244 Membership List

Mr. Selçuk ATAC  
TÜBİTAK – SAGE Flight Mechanics  
Department, PK 16  
06261 Mamak/Ankara  
TURKEY  
Email: [satac@sage.tubitak.gov.tr](mailto:satac@sage.tubitak.gov.tr)

Mr. Osman BASOGLU, PhD  
TÜBİTAK – SAGE Flight Mechanics  
Department, PK 16  
06261 Mamak/Ankara  
TURKEY  
Email: [obasog@sage.tubitak.gov.tr](mailto:obasog@sage.tubitak.gov.tr)

Mr. Kaan DOGAN  
TÜBİTAK – SAGE Electronic Design  
Department, PK 16  
06261 Mamak/Ankara  
TURKEY  
Email: [Kaan.dogan@tubitak.gov.tr](mailto:Kaan.dogan@tubitak.gov.tr)

Dr. Henk W. JENTINK  
National Aerospace Laboratory (NLR)  
Flight Test Systems and Applications  
Department  
Anthony Fokkerweg 2  
1059 CM Amsterdam  
NETHERLANDS  
Email: [jentink@nlr.nl](mailto:jentink@nlr.nl)

Mr. Wilson (Rusty) LOWRY  
US Naval Test Pilot School  
22783 Cedar Point Road  
Building 2168  
Patuxent River, MD 20670  
UNITED STATES  
Email: [wilson.lowry@navy.mil](mailto:wilson.lowry@navy.mil)

Col. Orhan NADAR  
1st ASMC İnci HİBMK.ligi  
26320 Eskisehir  
TURKEY  
Email: [orhannadar@hvkk.tsk.tr](mailto:orhannadar@hvkk.tsk.tr)





## Chapter 1 – BACKGROUND AND HISTORY

Aviation ordnance includes the weapons and ammunition that will ensure successful implementation of the missions [1].

During World War I small air-to-ground bombs were dropped over the side of planes by the pilots and ground distribution patterns were quite scattered. Moreover, these operations were more effective from a morale standpoint than in terms of casualties produced or damage to enemy installation. In the interim, between World War I and World War II, a variety of weapons were perfected for aircraft usage. During World War I, the military employment of such weapons was extended to include various bombs and rockets.

At the start of the World War II, a typical bomb fell up to 3 miles from target (daytime) and up to 5 miles away at night. At the end of World War II, the Circle of Error Probable (CEP) had been reduced to about 1000 yards and at the same time great advances had been made in flight speed and ability to operate at high altitude. Thus the utility of the planes was greatly extended (Figure 1-1).



**Figure 1-1: Bomber A-24 (Used Between 1940 and 1944).**

But still, destroying a single given military target required destroying a whole square mile of city to be certain of hitting the target, i.e. carpet bombing which requires huge bomber strings of 1000 – 2000 bombers. The atomic bomb was an incomparably more efficient weapon, i.e. a single aircraft capable of immense destruction. Instead of carpet bombing, a single atomic bomb was enough for destroying a huge city and hence the military target. On the contrary, smart bombs was a new and different approach compared to old approaches and this new approach made planes capable of hitting individual building, i.e. radar infrastructure or moving target with single bomb and the advantage of minimum collateral damage was gained. In addition to improvements in successful target hitting, there had been big improvements about bomb carriage and as a result, internal bomb carriage had begun. Internal bomb carriage had several advantages such as minimum effect on aircraft performance except for weight and minimum effect on stability or control except center of gravity effects. Internal bomb carriage had also added new problems especially about release and separation. These improvements in both airplane and store performances have created additional problems concerning the design and employment of weapons.

In 1950's, Bomb Bay Nuclear Deterrent begun and planes B-47, B-52, Vulcan, Victor and Bear came into action with special properties such as internal bomb carriage, minimum effect on performance and stability,

## BACKGROUND AND HISTORY

---

high altitude flight capability, one 'g' release, low dynamic pressure and finally dropping of importance of gravity from bomb carriage. In the 1960's Limited Conventional War begun and fighter/bomber kind planes came into action with external store carriage.

External store carriage introduced several problems which can be listed as:

- Gross effects on performance; Weight and drag:
  - Degraded flying qualities; CG, lift and drag, stall characteristics; and
  - Serious effects of aerodynamics on stores.
- Aeroelastic effects with stores.
- Separation problems; Use of ejector racks.
- Flow field effects on trajectories.
- Steep dive angle / high g / high-speed deliveries.
- Serious problems with accuracy.

In USA, starting with 1966 USAF recognized that aircraft/stores compatibility is a separate requirement. So, scientists had to endeavor to reduce possible loading configurations such as:

- Compile data on stores and aircraft;
- Define a procedure for store certification;
- Use of extensive analytical techniques;
- Use of low-cost wind tunnels when required;
- Minimize flight test time in certification;
- Update and verify trajectory by analytical methods; and
- Develop testing methods for computerized weapon delivery systems.

In the early stages of air warfare, aircraft/stores compatibility was not a significant consideration except to ensure that weapons would fit onto and function with a carrier aircraft. During the Vietnam War, aircraft that entered the inventory were large and powerful enough to carry significant amount of weapons. Also, many new weapons were being developed. The management of the resulting integration projects of stores to different aircrafts resulted in a huge matrix of combinations that had to be identified, prioritized, analyzed and certified in a timely manner.

Moreover, in the 1970's other countries started to make large inventory of munitions (~100), and these munitions needed to be flown on all fighter/bombers. Therefore, Triple Ejector Racks (TERs) and Multiple Ejector Racks (MERs) developed to carry as many bombs as possible and this resulted in about 6,000,000 possible loadings. And this result naturally led to:

- Confusion for ground crews;
- Many unauthorized configurations;
- Seriously degraded performance and flying qualities; and
- Huge store certification flight test programs.

At the end of the Vietnam War, the McDonnell Douglas F-4 Phantom was the USAF's main tactical combat aircraft. Virtually every store in existence was certified for use on the F-4. In the late 1970s, the USAF decided to replace the F-4 with the General Dynamics F-16 Fighting Falcon. The F-16 exhibited many more

incompatibilities with weapons than the F-4 did. As the F-4 was phased out, the F-16 combat users found they were not getting the quantity and quality of combat capability they were expecting and used to before. Their mounting frustration culminated in 1986 when the Commander of the Tactical Air Command challenged USAF Head Quarter to fix the problem. Head Quarter directed the SEEK EAGLE revitalization study. That study resulted in the establishment of the Air Force Seek Eagle Office (AFSEO) in December 1987, when the office was chartered by the Secretary of the Air Force. After establishment of AFSEO the office has been taking care of all the aircraft/stores compatibility issues.

For economic efficiency, for both organizational and operational reasons, most military platforms are designed as multi-role platforms. Each specific mission profile requires weapon pairing or the assignment of optimal weaponry for the given mission. Weapon pairing involves the delivery of a particular load of a particular store or a specific combination of different store types and loads. The wide range of mission profiles required from modern military flying platform necessitates the option of carrying a variety of stores and loads.

During all successful programs, all the integration activities of weapon systems are fully integrated with the capability development and systems engineering conducted. Aircraft stores clearance and certification activities and test and evaluation methods are discussed partially in, AGARD300-V05 [2], AGARD300-V24 [3], MIL-HDBK-244 [4], Guide to Aircraft Stores Compatibility and MIL-STD-1763 (1984), Aircraft/Stores Certification Procedures and more recently with MIL-HDBK-1763 (1998) [5].



## Chapter 2 – GENERAL OVERVIEW OF WEAPON SYSTEMS AND INTEGRATION INTERFACES

Many different types of weapon can be found in the inventory of air forces around the world. These will range from ballistic bombs, through smart bombs with control mechanisms that improve accuracy, to powered weapons having a greater range (air-to-air and air-to-surface missiles). Integration of each weapon type requires different integration approaches during certification.

### 2.1 WEAPON DESIGNATIONS

Weapons can be classified as given below:

- Dump/unguided General Purpose Bombs (GPs);
- Dump/unguided Cluster Bombs (CBUs);
- Laser-Guided Bombs (LGBs);
- Inertial-Aided Munitions (IAMs);
- Air Intercept Missiles (AIMs); and
- Air-to-Ground Missiles (AGMs).

A sample picture of AGM type store on F-16 aircraft is presented in Figure 2-1. The munitions are designated with short codes to define properties and operational usage characteristics. As an example some of the codes that are used worldwide are given in Figure 2-2, Figure 2-3 and Table 2-1 [6].



Figure 2-1: AGM on F-16 Aircraft.

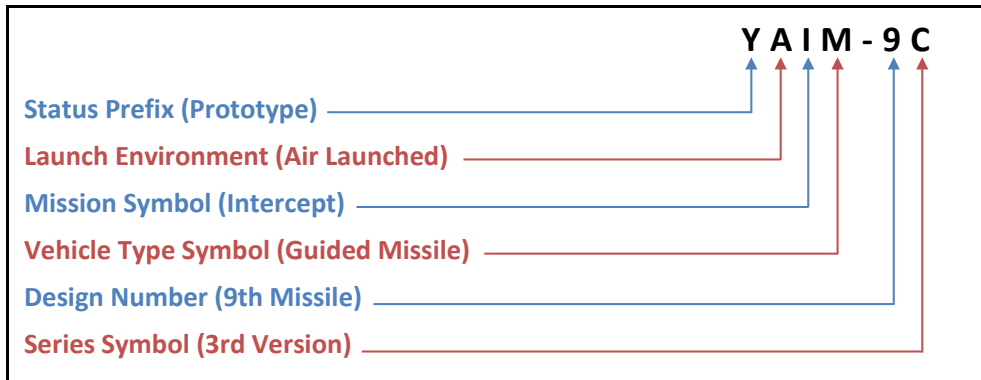

Figure 2-2: Designations for US Missile Systems.

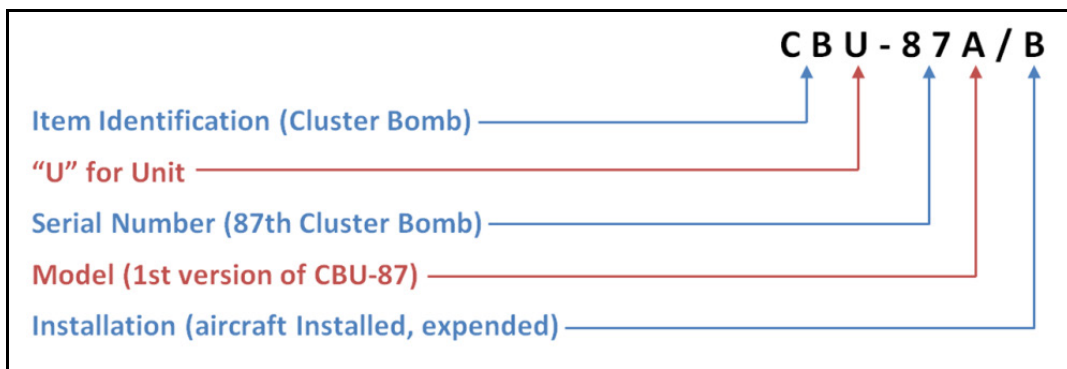

Figure 2-3: Munitions Designations for US Systems.

Table 2-1: Designation Codes for US Missile Systems.

Status	Environment	Mission	Type
J : Special Test/Temp	A : Air	D : Decoy	L : Launch Vehicle
N : Special Test/Perm	B : Multiple	E : Special Electronics	M : Guided Missile
X : Experimental	C : Coffin	G : Surface Attack	N : Probe
Y : Prototype	F : Individual	I : Intercept Aerial	R : Rocket
Z : Planning	G : Runway	Q : Drone	
	H : Silo Stored	T : Training	
	L : Silo Launched	U : Underwater Attack	
	M : Mobile	W : Weather	
	P : Soft Pad		
	R : Ship		
	S : Underwater		

## 2.2 UN-GUIDED (BALLISTIC) BOMBS

Ballistic bombs are un-guided and aerodynamically stable configurations. These weapons are inherently inaccurate, since their delivery requires the launch aircraft to perform complex aiming calculations to determine the release point that will maximize the probability of hitting the target. All ballistics bombs are made up of a number of constituent parts, these being the explosive warhead, the fuze [7], a tail arrangement, and possibly a height sensor that is used to detonate the bomb prior to impact. The main body of the bomb comprises the warhead to which various tail units can be fitted depending on mission requirements.



When released, a low drag bomb will follow a ballistic trajectory until the fuze either detects an impact or is notified by the height sensor that the air burst height has been achieved. The bomb fuze is typically programmable by switches located on the fuze for setting arming and initiation delays. Low drag un-guided bombs would typically be released from a medium altitude (around 3000 m) to higher altitudes to maximize the stand-off range. On the other hand, retarded (high drag) bombs are used for low-level releases where the retarding mechanism reduces the velocity of the bomb, so that the aircraft can escape the debris zone when the bomb detonates Figure 2-4).



**Figure 2-4: F-111F Aircraft Releasing its Load of Mark 82 Retarded Bombs.**

These bombs are installed to the aircraft by using a common mechanical interface. NATO aircraft and bombs generally use “hook-and-eye” mechanical attachments defined by STANAG 3726 [8]. The hook mechanism is part of a release unit or bomb rack operated either by the initiation of a pyrotechnic cartridge (the product of which is a high-pressure hot gas) or by the release of compressed gas (usually purified air in a so-called cold gas system). In both systems, in addition to opening the hooks, the gas is used to operate pneumatic rams that push the weapon away from the aircraft, so helping aerodynamic separation. Older systems or systems for very light stores may be operated by energizing a solenoid to open the hooks. On these systems, the store falls away from the aircraft under the influence of gravity. Figure 2-5 shows a typical bomb rack.



**Figure 2-5: Example of a Bomb Rack (MAU-12).**

The weapon is mechanically attached to the aircraft by closing the hooks to grab the eyes fitted to the weapon (bale lugs) and then lanyards are attached that will remove locking pins from the fusing mechanism when the bomb separates from the aircraft. Modern fuzes contain a thermal battery (a chemical device initiated by a pyrotechnic squib) that is activated by a fusing power supply switched through to the fuze by the aircraft on release.

Targeting of these type of stores can be employed in two different ways namely; pre-planned or Targets of Opportunity (TOO). With a pre-planned target, the target type and location is known prior to the aircraft sortie enabling the optimum method of attack to be devised. During the mission planning stage, the approach route to the target, the attack, and the egress route can be meticulously planned and rehearsed such that the probability of destroying the target can be maximized.

Targets of opportunity are targets that are identified while the aircraft is in flight and therefore do not have a mission plan to follow. The location of the target must therefore be fixed using either on-board sensors or from a third party relaying target co-ordinates to the aircraft. The pilot must enter the target co-ordinates into the attack system, so that the aircraft can be steered to the weapon release point. Targeting using only the aircraft's own sensors to identify the target's location will inherently result in a Target Location Error (TLE). The navigation and attack systems need to be highly accurate if TLE is to be minimized.

The accurate delivery of unguided ballistic bombs relies on the accuracy of the aircraft's navigation system to determine the aircraft's exact position, altitude and three-dimensional velocities in order to minimize targeting errors. Modern aircraft have multi-sensor systems where the navigation solution is derived using techniques that may include a combination of inertial sensors, radar, GPS, visual fixing systems, Kalman Filtering, etc. The aircraft's weapon aiming system will compute the impact point of a bomb if released from its current location during its flight path. This calculation will be repeated continually at a rate largely dependent on the processing power available in the weapon aiming computer and any other tasks that the system needs to undertake. The bomb is released when the weapon aiming system determines that the CCIP overlays the target's position. The system will have processing delays, data transmission delays, and system latencies that must also be accounted for in the aiming solution. The weapon aiming system therefore needs to advance the release point to account for these delays. However, as the weapon aiming calculations are cyclic and take a finite time to complete, then the point where the CCIP overlays the target exactly may in reality, occur part way through a processing cycle. It is therefore necessary for the designer of the weapon aiming algorithms to undertake statistical analysis to determine the error in the true release point and the calculated release point solution so that this too can be factored into the overall calculation, thereby minimizing system – induced errors.

As a ballistic bomb is un-guided, when it is released from the aircraft it will fall in accordance with the physical laws of motion. While theoretically this provides a level of predictability, in reality there are many factors that influence the bomb's trajectory. These include the aircraft speed and attitude at the point of release, the downward ejection force imparted by the aircraft bomb rack, wind velocity and direction (which itself will vary from the release point throughout the trajectory), and the air density profile from release to the target. The effects of aerodynamic drag will also influence the weapon aiming solution. Much effort is expended during the design of the weapon aiming algorithms to ensure that an approximation of the bomb's trajectory can satisfy all the variables such that miss distance is minimized. The actual impact point of a weapon will have a Gaussian distribution about the mean impact point with ideally, the mean impact point coinciding with the target's location. In practice it rarely does.

Low-level releases of retarded bombs are more complicated since the aircraft must be clear of the blast debris when the bomb detonates. Since bomb fragments could have a velocity in the region of 1,000 m/sec the maximum energy boundary of such fragments will need to be included in the weapon aiming computations so that the aircraft can remain safe for the given set of release conditions. At a pre-determined time after release the bomb's fuze will arm in readiness for the conditions required for detonation to be achieved.



## **2.3 GUIDED (SMART) BOMBS**

A smart bomb consists of a guidance kit that is attached to a ballistic bomb. The earliest bombs that could be considered to be in this category are laser-guided bombs that were developed in the USA during the 1960s. Other early bombs such as the GBU-15 employed a video sensor, movable control surfaces and a radio link with the launch aircraft that enabled the bomb to be steered onto its target. Following the 1991 Gulf War, the USA identified the need for higher-precision weapons that would have improved kill efficiencies. These truly smart bombs such as the Joint Direct Attack Munition family of weapons use a relatively low cost GPS-aided inertial unit coupled to a simple flight control system to guide the bomb to a target's GPS co-ordinates.

When released, a smart bomb will initially follow a ballistic trajectory. The guidance system enables the weapon to be steered towards its target within certain constraints. The control surfaces can also provide a level of aerodynamic lift that will provide some extension to the weapon's range. Indeed, some weapons can be fitted with wing kits to extend the range still further. However, as most smart bombs are un-powered, their range is limited by their potential and kinetic energy at launch. These types of bombs, for example, those with laser guidance kits or Global Positioning System (GPS) assisted inertial navigation systems, have a degree of maneuverability that can be exploited to increase terminal accuracy. For these weapons, the launch aircraft must align the weapon's navigation system prior to launch.

The stand-off range of ballistic and guided bombs is dictated by the kinetic and potential energy of the weapon at release, which are, in turn, dependent on a number of factors, such as the launch altitude and aircraft speed. In order to increase the stand-off capability, missiles contain a source of propulsion such as a turbojet or rocket motor. While increasing the effective range of the missile, a propulsion system can also reduce the time for the missile to engage its target. This is a key factor for an air-to-air missile. Powered air-to-ground weapons also employ either a rocket motor (e.g. for a high-speed short-range weapon) or turbojets (e.g. for a long-range cruise missile).

There are several major sub-systems which are common in air-launched weapons such as seeker, guidance, target detector, controller, warhead, propulsion unit, battery and umbilical.

The seeker (Figure 2-6) is composed of a sensor for target tracking, and supporting electronic components according to the method used for this purpose and it is placed nose part of guided weapons.

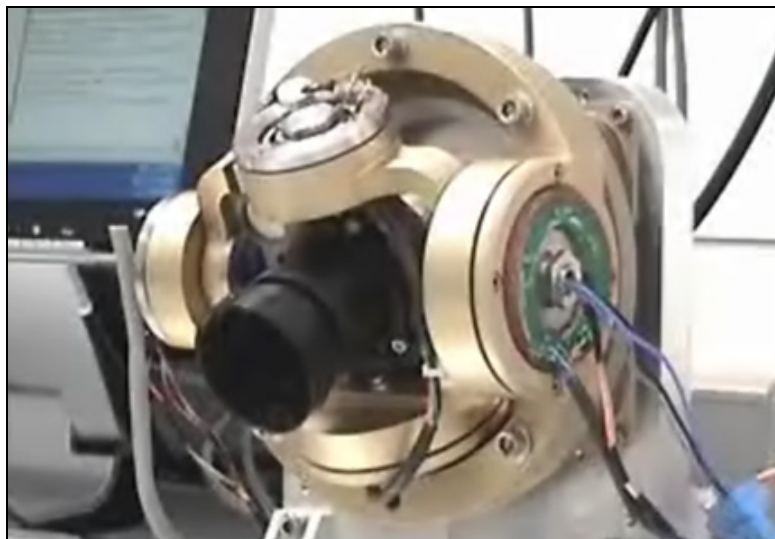

**Figure 2-6: Seeker.**

Sensor may differ according to mission of the missile and can be an active or passive radar, infrared, ultraviolet or optics based. In general, most of the systems contain a gimbaled gyro package for space stabilization and may contain an Inertial Navigation System (INS) or Global Positioning System (GPS) for precision navigation. Each sensor type has an associated physical limiting such as field of view, field of regard and operational limitations such as weather, day or night operations, smoke or electronic jamming.

Guidance section is responsible for guiding of a missile or a guided bomb to its pre-defined target. Hence it is a critical part to achieve accuracy and effectiveness of the system. Guided missiles were first developed with German V-weapons program. There are several guidance methods that can be used to direct the store to its target. However, methods can be divided in to two main groups as Go-Onto-Target (GOT) and Go-Onto-Location-In-Space (GOLIS).

In the first group either Line Off-Sight or Homing Method can be used. Line Off-Sight guidance system uses the angular difference between the missile and the target to calculate the collision point. The missile will have to be in the line of sight between its current position and the target and have to correct deviations from this line. Homing guidance systems use a radar system on the missile itself or on the firing platform to illuminate the target and to provide a guidance signal. The missile keeps tracking of the angle between its own centerline and the radar signal reflection.

On the other hand, in GOLIS systems, there is a lack of target tracker. In these systems, guidance computer and the missile tracker are located in the missile itself and there is only one type of guidance system of this kind named as Navigational Guidance. These systems use either INS, GPS or both of them.

Inertial guidance calculates current the location of the missile by integrating the accelerations measured by rate devices after leaving from a known position. Hence its accuracy is based on the accuracy of the mechanical sub-systems. Modern systems use solid state or ring laser gyros that are accurate to within meters over ranges of several thousands of miles. Today guided bombs can use a combination of INS, GPS and radar terrain mapping to achieve extremely high levels of accuracy such as that found in modern cruise missiles.

As another common sub-system, fuzing mechanism may use time, proximity, impact or pressure during its operation. Most weapons use impact fuzes which sense high gravitational (g) forces when the weapon hits the target. Some versions of the impact fuzes incorporate a delay in detonation to allow the weapon to penetrate the surface. A timing sequence is initiated at release and the weapon is armed after given amount of time in timing-based fuzes. On the other hand, proximity fuzes calculate the proximity to the earth which is measured by either a barometric or radar altimeter. Fuzes used by a smart bomb are identical to those used in ballistic bombs. However, as fuze technology develops, new fuzes are being developed specifically for smart bombs.

The inclusion of electronics means that the weapon has to include a battery power source. The battery is initiated just prior to launch, either by an electrical fusing supply switched through to the bomb when the bomb rack hooks are opened, or by the use of a smart weapon interface such as that defined by MIL-STD-1760 [9]. Thermal batteries are widely used as primary power sources in guidance tail kits, fuzes, missiles, acoustic jammers/emulators, guided artillery shells and aircraft ejection seat systems. They are non-rechargeable (they are for single use) and they are the ideal energy source to supply the instant and high levels of electrical power requirement of advanced munitions systems. The main sub-components of thermal battery are presented in Figure 2-7. With the ignition of the electro-explosive initiator, the temperature in the battery increases rapidly, above 400°C. Within this temperature, electrolyte melts and as a result of the chemical reactions electrical power is obtained. Through the terminals, the electrical current is transmitted to the system that requires the energy. The basic advantage of thermal batteries are; their long and maintenance free shelf life (> 20 years), short activation requirements and their suitability to alternative activation methods (electrical igniter, percussion cap, inertial igniter).

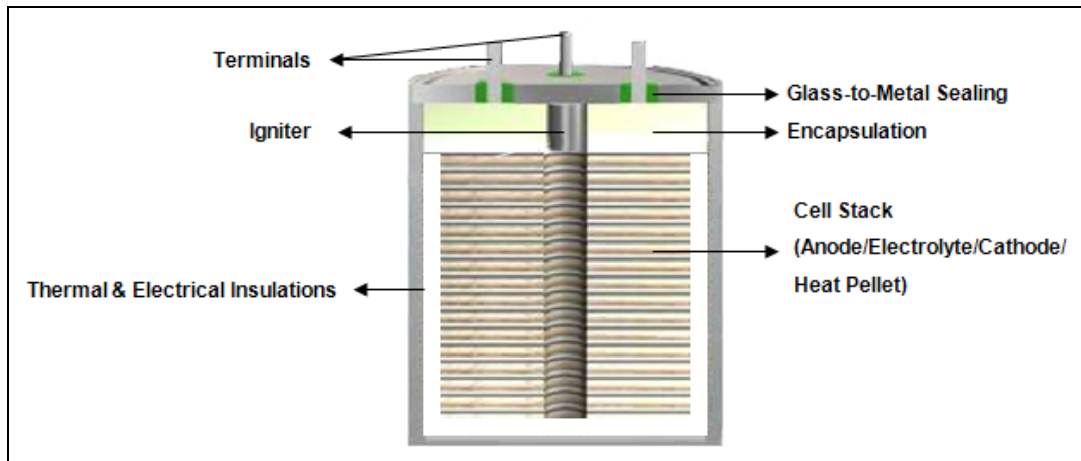

**Figure 2-7: Cross Section of a Thermal Battery.**

Propulsion unit is the part of the weapon which is responsible to sustain required thrust for the given mission. There are several different propulsion system choices that can be used in a weapon system, such as turbofan/turbojet, ramjet, ducted rocket, scramjet, and solid rocket. The efficiency of propulsion alternatives for a range of Mach numbers are given in Figure 2-8 [10].

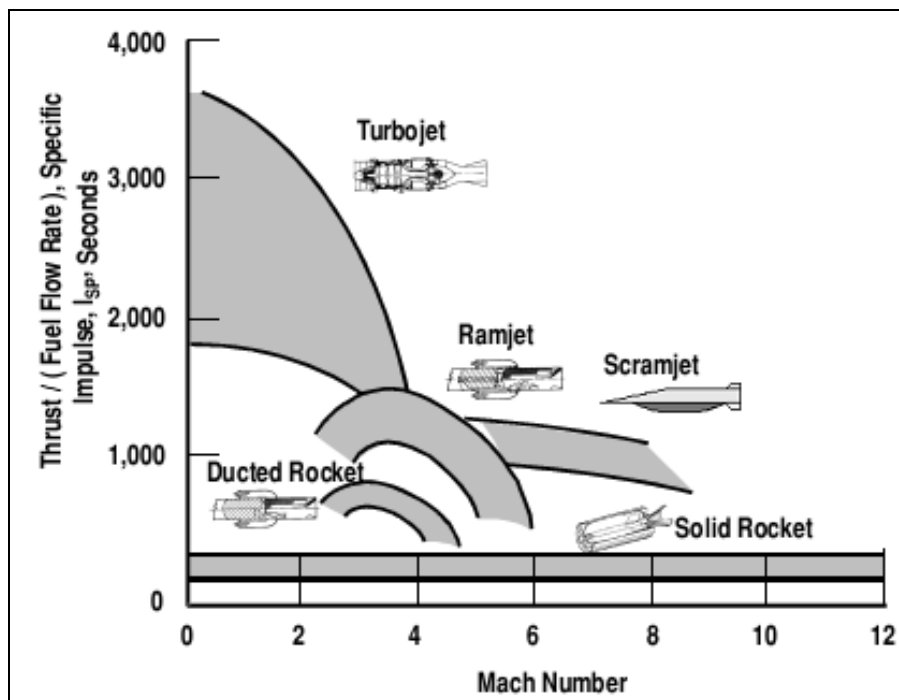

**Figure 2-8: Efficiencies of Propulsion Alternatives Across the Mach Number.**

Turbojet/turbofan propulsion alternatives are mature technologies and they are suitable for subsonic air-to-ground missions in which flight time is not a concern. As the Mach number increases above 2, inlet design becomes more complex and material properties limits the operational envelope of the system. Above this Mach number a ramjet becomes a more efficient choice from Mach 2.5 to 5. Temperatures attained at the engine and chemical dissociation at the inlet limits the operation of this type of propulsion unit above Mach 5. For a subsonic launch platform, a rocket boosts the missile to the ramjet thrust takeover at about Mach 2.5.

The maximum specific impulse of ducted rocket propulsion is about 800 s, which is intermediate to that of a solid rocket and a ramjet. Ducted rockets are most efficient for a Mach number range of about 2.5 to 4.0. Ducted rockets have higher acceleration capability (higher thrust) than ramjets and generally have longer range capability (higher specific impulse) than solid propellant rockets. Scramjet propulsion has supersonic flow through the entire flow path, including supersonic combustion. Scramjet propulsion challenges include fuel mixing efficient combustion, and airframe integration. A longer combustion chamber is required for a scramjet compared to a ramjet, because of the longer mixing time for supersonic combustion. The airframe integration alternatives are using an internal nozzle vs. using the aft airframe bottom surface as an equivalent nozzle. The scramjet is boosted to a thrust takeover speed of about Mach 4, requiring a large booster for a subsonic launch. Efficient cruise is about Mach 6, 100,000 ft. in altitude. Solid rockets are capable of providing thrust across the entire Mach number range. Although the specific impulse of tactical rockets is relatively low, on the order of 250 s, rockets have an advantage of much higher acceleration capability than air breathing propulsion. Also, their ability to operate at high altitude enables a boost-climb-glide trajectory to extend range by minimizing drag.

As a valuable weight, warhead incorporates a series called an explosive chain. The weapon causes its damage by fragmentation, blast, or incendiary by using its warhead. Warhead starts an explosive chain when initiated and this chain is composed of primary, delay, detonator, booster, and bursting charge. All weapons have safety mechanisms in place that prevent inadvertent release on the ground and in the air or harmful detonation too close to the carrier platform.

Smart bombs utilize the standard mechanical and fusing attachments used by ballistic bombs. However, as a smart bomb is likely to contain electronics such as navigation and flight control systems, the primary system interface will be as defined in standards such as MIL-STD-1760 [9].

With the guidance capability of smart bombs it is possible to trade energy at release with route to the target. Clearly, if the weapon has sufficient energy at release and sufficient maneuverability, then it is feasible to hit the target from a variety of pre-defined direction and azimuth and elevation angles. This complicates the mission planning activity but does provide a greater level of flexibility for the attack.

Where the accurate delivery of un-guided ballistic bombs requires the aircraft to be in a specific location in its flight path with a defined attitude and speed, a smart bomb does not have such stringent constraints. In effect the aircraft need only be in a defined three-dimensional volume in the sky. This volume will vary with altitude, speed, distance from the target, and weapon performance. This overcomes the need for the aircraft to calculate the CCIP. However, there is still a need for the aircrew to know when the smart bomb can be released such that it will hit the target. The volume in the sky where, if released, the bomb will reach the target is known as the launch basket or Launch Acceptability Region (LAR) (see Figure 2-9).

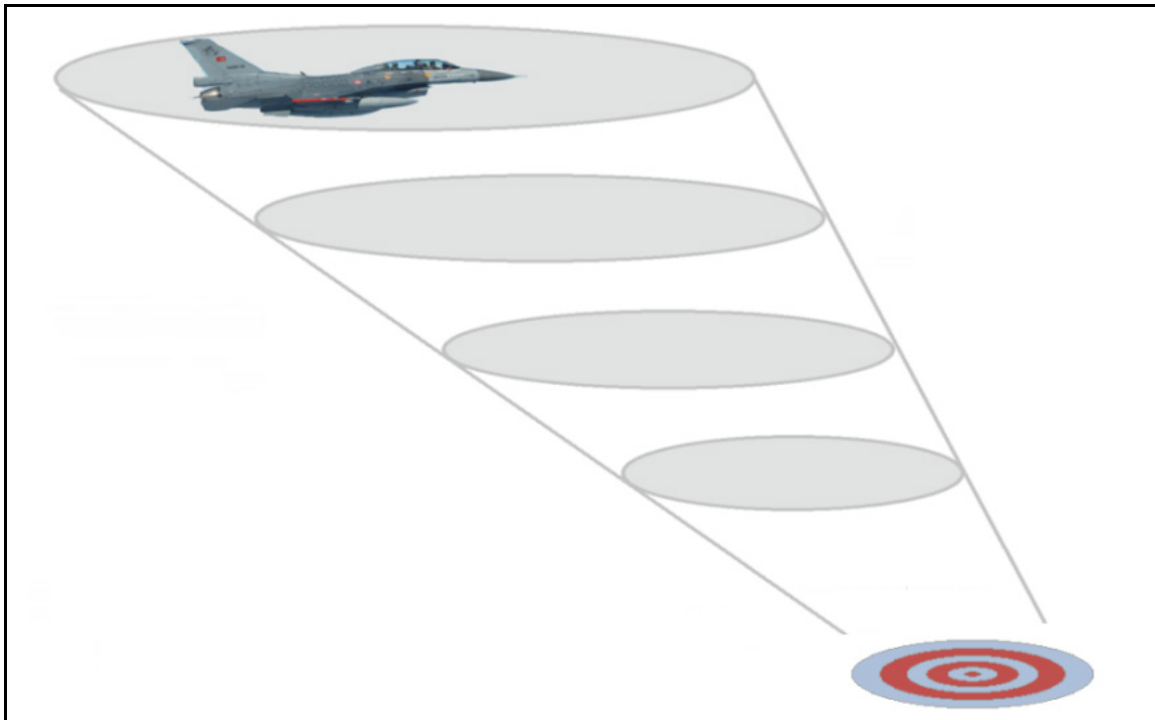

**Figure 2-9: Launch Acceptability Region.**

While Figure 2-9 shows the LAR in relation to a point target, it can also be shown as a projected “footprint” on the ground (in effect, an inversion of Figure 2-9). This would then show all the possible impact points if the weapon was “launched now”.

The LAR is dependent on the actual release conditions and will change as these parameters vary. The LAR is therefore dynamic, requiring continuous calculation that places greater demands on the weapon aiming system’s processing power, particularly if a number of smart bombs are to be released in a single attack against dispersed targets.

The primary method of defining the LAR is to employ a 6-DOF model that can predict the weapon’s trajectory from release to impact for a given set of conditions. The 6-DOF model uses the dynamics of the weapon movements (body rates, angles, etc.), the environmental conditions (temperature, air density, wind speed, etc.), and the weapon’s flight control system dynamics to predict the weapon’s trajectory. The 6-DOF model is considered to provide a true representation of the dynamics of the weapon. However, the continuous processing of a 6-DOF model in an airborne computer would be prohibitively complex. It is for this reason that the models are simplified to give a good approximation of the true weapon performance. Two methods are commonly used, these being the dynamic LAR and the parametric LAR.

A dynamic LAR employs the equations of motion based on the physical characteristics of the weapon in a similar way to a 6-DOF model. However, the equations are simplified usually by considering a reduced number of degrees of freedom, typically a 3-DOF model. The parametric model is matched to the output of the 6-DOF model but uses an approximation such as “least squares fit”.

LAR displays are often simplified as shown in Figure 2-10. In this example, markers for the maximum and minimum In-Range and In-Zone LARs are displayed to the crew. In the figure, the plane of the LAR is indicated to show how the markers displayed to the crew are constructed. Here, LAR cross-track limits may also be displayed to the crew (as shown) in order to improve overall situational awareness.

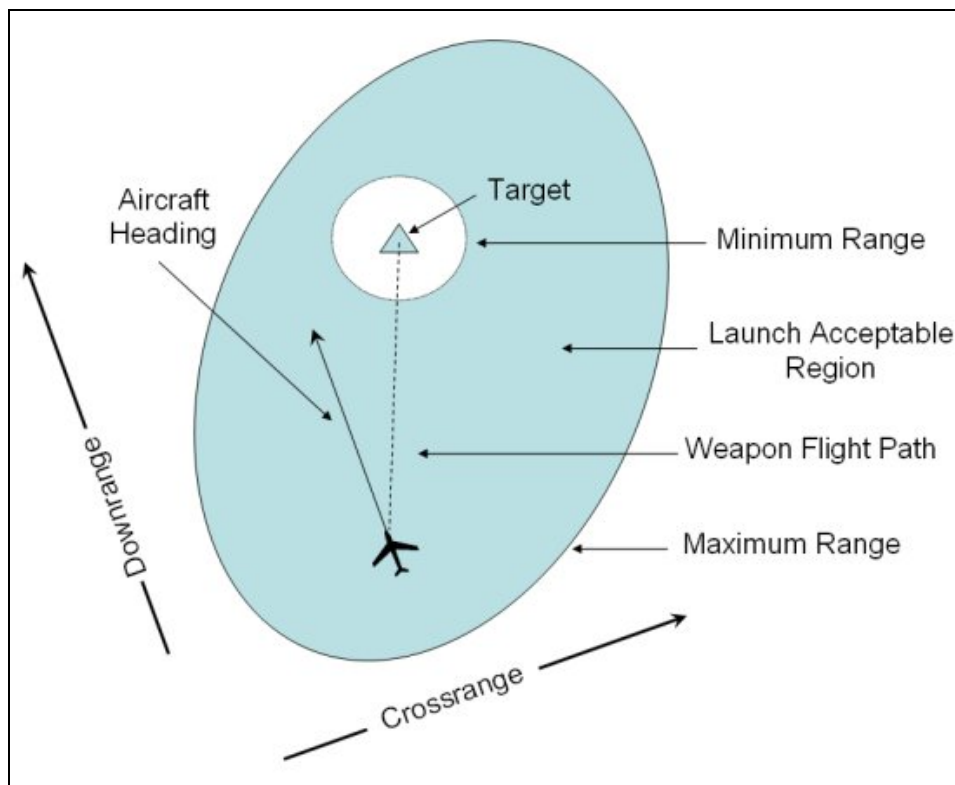

Figure 2-10: Typical Aircraft LAR Display.

When combining LARs for several weapons, the resulting LAR will be of a significantly reduced volume. Here, the update rate of the combined LAR may become critical as minor changes in parameters for all individual LAR computations can cause dramatic changes in the combined LAR. Displaying multiple LARs to the aircrew therefore places significant demands on the display computer and graphics generator.

As weapons are developed in isolation then it is not uncommon for an aircraft's weapon aiming computer to hold several different LAR algorithms for different weapons. This means that should a particular algorithm need to be modified, it can be very expensive.

After launching of the smart bombs within the LAR, they will guide themselves to their designated target using a navigation solution produced by its own systems and following a glide path dictated during mission planning. For optimum performance, a smart bomb would be released when inside the LAR. However, should there be a reason why the launch aircraft cannot achieve the LAR required to satisfy the desired impact conditions, then it may be possible to trade reduced maneuverability with release from a greater stand-off distance from the target. It is for this reason that two LAR's may be calculated. The first is the so-called "In Zone" LAR where the weapon, if released, will attack the target with the desired impact conditions. The second is the "In Range" LAR where the weapon, if released, will have sufficient energy to reach the target but where the trajectory contains the minimum of maneuvers, trading increased stand-off range for reduced end-game maneuverability.

Smart bombs can be used to attack targets of opportunity but their accuracy is dictated by the accuracy of precision code GPS. This places a greater reliance on the sensors used to locate the target to minimize TLE.

One of the main shortcomings of smart bombs is that their maximum range is limited to around 15 to 20 nautical miles (depending on launch altitude). In certain scenarios smart weapons with a greater stand-off range are required which can be achieved in two ways:



- With a range extension kit (normally a deployable wing kit that provides additional lift, enabling a greater glide range); and
- With a source of propulsion such as a small turbojet or rocket motor.

A smart bomb fitted with a wing kit is operated in an almost identical way as the weapon without a wing kit. However, due to the greater stand-off range, the LAR algorithms need to be modified to account for the greater footprint. The weapon may also need to have an increased capacity energy source to power weapon sub-systems for the full duration of the extended flight time.

A smart weapon with a propulsion system such as a turbojet typically has a large stand-off range and is classed as a cruise missile. Once launched, a typical cruise missile is completely autonomous guiding itself to the target using a range of techniques such as GPS navigation and scene matching algorithms. Scene matching uses a sensor to match the visible scene during the end-game with a digital image loaded into the weapon's guidance system. The error between the sensed "real" scene and the stored image is used to make final course corrections, thereby improving the terminal accuracy of the weapon. Figure 2-11 shows an example of such system which is called Turkish Stand-Off Missile (SOM).



**Figure 2-11: Turbojet-Powered Cruise Missile.**

Weapons with a rocket motor have a limited range but are able to prosecute target engagements quickly. Such weapons would typically include a seeker based on either laser, optical, or radar technology, depending on the target types being engaged and the operation of the overall system (e.g. whether it includes a human in the guidance loop or has an autonomous "fire-and-forget" capability).

## 2.4 IMPORTANT AIRCRAFT/STORES INTERFACES

### 2.4.1 Stores Management System (SMS)

An essential element of the aircraft system is the SMS. The SMS is the avionics sub-system which controls and monitors the operational state of aircraft installed stores and provides and manages the communications between aircraft stores and aircraft sub-systems, and manages the weapon load-out and controls the safe release and jettison from the aircraft.

From a safety and certification viewpoint it is essential that an aircraft only releases a store when intended. This appears to be an obvious requirement but it is the primary driver in the design of the armament system and it is this requirement that adds complexity to the design of the SMS.

The SMS provides the capability for management and control of weapons configurations loaded on the aircraft in accordance with mission requirements. SMS functional capabilities include stores loading and inventory, selection of weapon delivery modes and stores profiles, and arming, release, and jettison of stores from the aircraft.

SMS performs these functions:

- Store identification, inventory, and status;
- Store activation and control;
- Store release, launch, and jettison;
- Store sequencing and delivery rate;
- Store verification and system integrity; and
- Video switching and power control at weapons stations.

The SMS provides multiplexed data communication linkages between displays, weapon delivery avionics, and store suspension equipment. In generally the SMS is linked to other sub-systems of the weapon system via the multiplex busses.

The first electrical release systems were based on relays that, when energized by the Bomb Aimer pressing the release button, would switch current to the bomb rack, causing it to open. To some extent, this provided a safe system as the relay contact provided an air gap that would prevent the bomb rack being operated. However, a short-circuit failure in the Bomb Aimer's button or a similar failure in the relay would mean that the bomb could be inadvertently released. This drove the design of systems with multiple breaks in the bomb rack firing chain such that a single failure, on its own, could not cause an inadvertent release. However, a significant drawback was that there were more components that could fail in a safe manner (i.e. open circuit) and therefore the system was less reliable. Another significant drawback was that the accuracy of the release point was determined by the skill of the Bomb Aimer and their reaction time. For ballistic bombs, this increased the release point error and therefore the terminal accuracy.

The introduction of a weapon aiming computer meant that the Bomb Aimer was now committing to release a weapon and it was the computer that was actually generating the signal to close the fire relays. This basic concept has evolved into the systems in today's aircraft.

A modern SMS is required to control the firing and release of many different types of weapons with varying release options and modes. This has driven the system design to include software, and for improved reliability and life, relays have been replaced by semiconductor switches. Figure 2-12 shows how these design principles could be implemented. In this figure a simple twin-channel system operating from dual power supplies is depicted. The release circuits are initiated from a multiple-pole release button. When both release circuits are operating correctly, each circuit switches its own upper switch in the channel's fire supply with the lower switch being controlled by the other channel. However, if BIT circuitry detects a fault in a channel, full authority to switch the fire supply is handed to the good channel. This implementation is protected against a single failure either causing an unintended release or preventing an intended release.



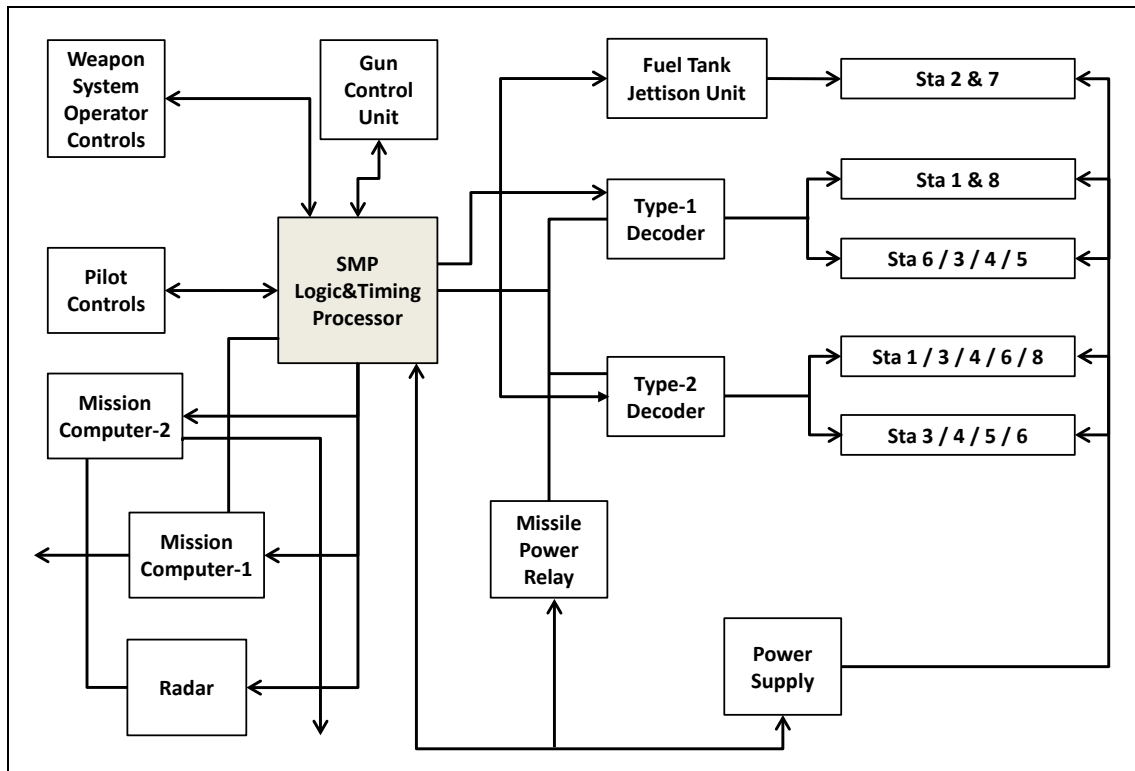

Figure 2-12: Simplified SMS Architecture.

A modern SMS also has to determine its own weapon inventory. Many smart weapons have the ability of telling the aircraft their operational usage purpose. This simplifies the logistics of preparing an aircraft for a mission and enables the aircraft to know exactly what is loaded on which station. This can be particularly important, as this information may be required by the aircraft's flying control system to alter performance parameters. Also, as stores are released, it may be important for continued controlled flight that the distribution of heavy stores is controlled such that their release does not impose an unstable condition on the aircraft (e.g. many heavy stores loaded on one wing with very few loaded on the other).

The modern SMS may also be required to control the safe (un-armed) jettison of stores from the aircraft under emergency conditions (for example an engine flame-out on take-off) when the mass of the aircraft may need to be quickly reduced.

All these demands make a modern SMS a complex system. Multi-channel systems that are designed to maintain integrity and availability are common. Such systems employ high-integrity software and are generally designed to be immune to electro-magnetic interference (to ensure the system remains safe at all times).

The primary means of monitoring and controlling the SMS is with the MFD/s in the cockpit. Other cockpit switches and controls are used by the pilot to command the SMS to execute the desired weapon delivery or jettison of stores from the aircraft.

The SMS determines the following information:

- All assigned store IDs and the store corresponding to each assigned ID;
- The flight control system category of each store;
- The fuze action of each store (if applicable);

- Allowable stations for each store; and
- The rack ID on which each store can be loaded.

The SMS functions are started by the pilot through switch or control inputs, accepted and implemented by SMS computer, and accomplished by the RIU/s at the weapon stations. Following stores control functions are driven by the SMS computer:

- Calculating stores weight and drag;
- Determining the flight, weapons and fuzes;
- Determining and reporting hung stores; and
- Discrete processing.

The SMS replaces the switches and selectors which would normally control guns, weapons and fuzes, weapon data, stores release programming, weapon data insertion panel and stores emergency jettison.

There are several configurations of possible store configurations that should be tested in the SIL Laboratory and on the aircraft during SMS validation. However, to shorten this process the aircraft inventory should be accomplished with the most common loading configurations and other possible configurations should be tested in the SIL. In this way, existence of any improper and incompatible loading configuration possibility must be cleared. Depending on the store properties, the SMS must demonstrate successful preparation of the weapon for delivery. The pilot must have enough confidence for stores availability and functionality for fire/release.

A bus analyzer can be used for this purpose to monitor bus messages during SIL test activities. Whole cycle from initiation to release must be recorded by using this tool. Post-inspection activities must include checking sequence orders and timing. In this way, hung store, unarmed store, or unguided munition problems can be monitored. Moreover, interlocks must be evaluated to show that release is inhibited if one or more of the required interlocks are not set. The easiest way to conduct this test is to repeat the sequencing with interlocks set and not set and verify the outcome.

#### **2.4.2 Weapon Interface Standard (MIL-STD-1760 [9])**

With the advent of smart weapons, the electrical interfaces employed were often bespoke and usually optimized for the specific weapon. This led to aircraft being required to provide many different interfaces. Aircraft pylons quickly became congested with wiring, dictating the need for aircraft to undergo a role change if a specific weapon type was to be operated.

This situation led people to develop a common interfacing standard for future smart stores (MIL-STD-1760). This standard defines an aircraft electrical interconnection system using a standard connector and providing a flexible signal set that contains various power supplies, media for transferring analog signals such as audio and video, a dual-redundant data bus for controlling the store, and a safety discrete signal. MIL-STD-1760 is the primary interface standard used by current smart weapons.

Aircraft/Stores Electrical Interconnection System defines a standardized electrical interface between a military aircraft and its carriage stores. Carriage stores range from weapons, such as Joint Direct Attack Munition (JDAM), to pods, such as AN/AAQ-14 LANTIRN, to external fuel tanks. Prior to adoption and widespread use of MIL-STD-1760, new store types were added to aircraft using dissimilar, proprietary interfaces. This greatly complicated the aircraft equipment is used to control and monitor the store while it was attached to the aircraft: the stores management system, or SMS.

MIL-STD-1760 defines the electrical characteristics of the signals at the interface, as well as the connector and pin assignments of all of the signals used in the interface. The connectors are designed for quick and

reliable release of the store from the aircraft. Weapon stores are typically released only when the aircraft is attacking a target, under command of signals generated by the SMS. All types of stores may be released during jettison, which is a non-offensive release that can be used, for example, to lighten the weight of the aircraft during an emergency.

There are five main groups of MIL-STD-1760 signals as given below:

- **MIL-STD-704 [11] Power Connections:** The MIL-STD-704 power connections provide the store with access to 28 VDC, three-phase 400 Hz, 115/200 VAC and 270 VDC aircraft power; it is usual to route only one of the last two supplies; however, if both are made available, then they are never made active simultaneously. The MIL-STD-1760 interface provides power through the primary interface (2 off 28 VDC and either one or both 115/200 V VAC and 270 VDC), where it is routed to the store along with all of the other signal types. The standard also allows for an optional auxiliary power interface (1 off 28 VDC and either 115/200 VAC or 270 VDC) for stores with more demanding power requirements. The auxiliary power interface includes its own interlock discrete signals so that the aircraft can determine whether the store's auxiliary power connector is attached to the aircraft.
- **MIL-STD-1553 [12] Data Communications Interface:** MIL-STD-1553 is a military standard for the digital time division command/response multiplex data bus that has been used since the 1970s for data communications between avionics devices on American military aircraft. It is a dual-redundant differential serial interface that operates at a rate of one megabaud. The MIL-STD-1553 interface includes four signal lines, five lines used to assign one of 31 communications addresses to the store (one address is reserved), and address parity and return lines, for a total of 11 lines.
- **High and Low Bandwidth Analog Signals:** The high and low bandwidth signals are for routing analog signals between the aircraft and the store. Note that either the aircraft or the store can be the source of the signal. The high bandwidth signals are intended for carrying video and other high-frequency signals, such as those transmitted by the Global Positioning System (GPS). The low bandwidth signals are intended for carrying audio and other low frequency signals.
- **Discrete Signals:** There are two sets of discrete signals. The Interlock discrete is used by the aircraft to determine whether the store is attached to the aircraft. This interface uses two signals, the Interlock, and the Interlock Return. These signals are simply connected together within the store, and when the store is released from the aircraft this connection is broken on the aircraft side. The aircraft determines the presence of the store by measuring the continuity between the two signals. Certain stores, typically weapons, may be commanded into modes that can be hazardous if not managed properly, such as the arming of a warhead. Activation of the Release Consent discrete signal is used to ensure that the store will only accept such a command when it is authorized to do so.
- **Fiber Optics:** The fiber optic interface is intended for much higher digital communications speeds than can be supported by MIL-STD-1553 [12], such as Fiber Channel, which can operate at gigabaud rates.

As an example of MIL-STD-1760 [9] interface usage for a weapon that uses GPS for terminal guidance, work breakdown structure is given in Figure 2-13.

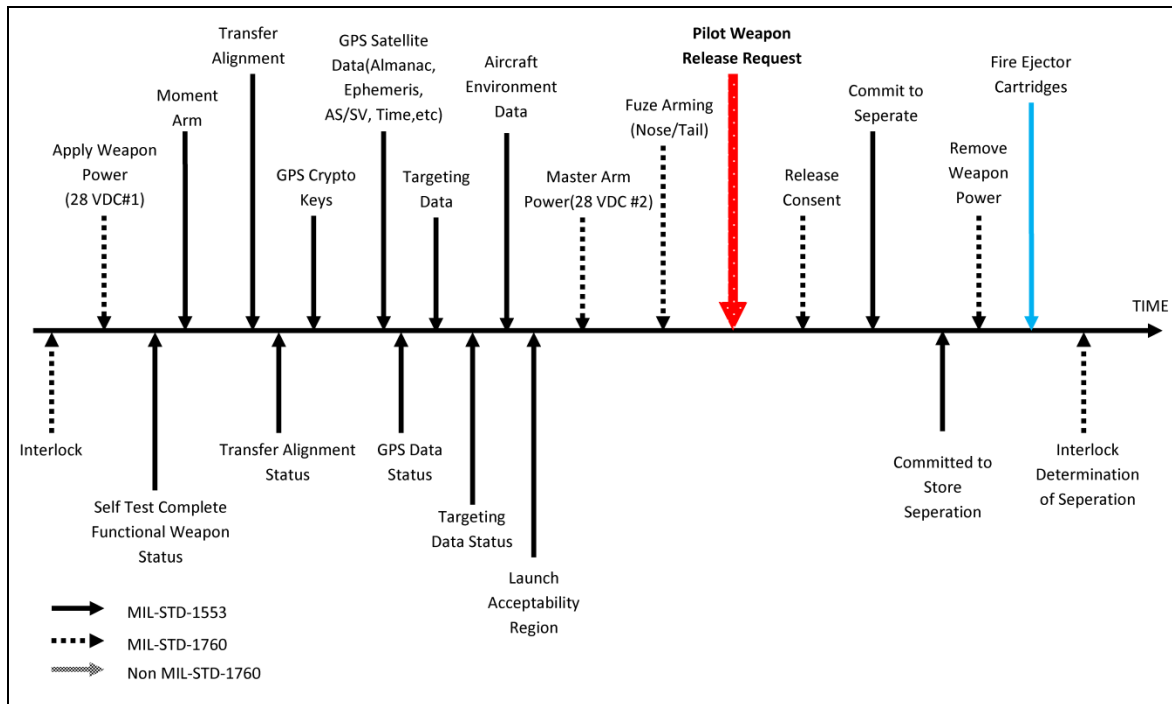

**Figure 2-13: Weapon Timeline.**

Prior to activating any of the store’s interface signals, the aircraft will examine the interlock discrete to ensure that the store is attached to the aircraft, thereby preventing the ground crew from being subjected to an electrical shock hazard while servicing the aircraft. The interface will be energized to supply the weapon with electrical power when the air crew determines that hostilities are imminent. The weapon electronics will initialize itself, including running a battery of self-tests and starting its MIL-STD-1553 interface communications [12]. The weapon will read its address from the settings on its MIL-STD-1760 interface and will start to listen for MIL-STD-1553 commands to that address from the SMS. These commands will commence with requests for the weapon to report its status, and will continue with commands that ready the weapon for its mission, such as navigation initialization and target co-ordinates. The weapon’s GPS receiver will be able to lock onto the signals from GPS satellites and resolve its position much more quickly after it separates from the aircraft if it is initialized with the current position and time. The aircraft may use the MIL-STD-1553 interface to send current position and time to the weapon, and a high bandwidth signal to route the GPS satellite signal from a topside aircraft antenna to the weapon.

Just prior to release, the aircraft activates the Release Consent discrete and sends the weapon an arming command using the MIL-STD-1553 interface [12]. The SMS will verify that the weapon release conditions have all been fulfilled, and it will activate the signals (not part of the MIL-STD-1760 interface [9]) that cause the weapon to be released. In the case of a bomb, this is typically done by energizing an electro-explosive device that simultaneously opens the hooks that hold the bomb on the aircraft during carriage, and also operate a plunger that pushes the bomb away from the aircraft (at high speeds there is a tendency for the weapon to remain in close proximity to the aircraft after the bomb hooks open). The MIL-STD-1760 connector will release as the bomb falls away from the aircraft, and the SMS will detect that the bomb has separated by the open circuit between the Interlock and Interlock Return discrete signals.

### 2.4.3 Armament Equipment

All guided/un-guided weapons and other stores are suspended internally or externally from the aircraft by Armament Equipment (AAE), which carry arm and release stores mechanically and supports

MIL-STD-1760 [9] communications. AAE is made up of items that support the expending or release of ordnance from aircraft such as bomb racks and launchers. It is important to note that AAE does not actually include the ordnance itself. In the following part details of this equipment will be given.

### 2.4.3.1 Launchers

Guided missile launchers provide for the carriage and launch of guided missiles from an aircraft. They provide the mechanical and electrical interface between the aircraft and the air-launched missile. Guided missile launchers are categorized as either ejection type or rail launchers. Ejection type launchers utilize gas pressure generated by cartridges fired in the launcher breeches to physically separate the missile from the aircraft. The missile motor is then ignited at a pre-determined distance below the aircraft. Rail launchers are normally carried on the wing stations. Rail launchers enable the missile motor to be activated while the missile is still attached to the launcher. After motor fire, the thrust generated by the motor overcomes the missile restraining device and the missile separates from the aircraft. The tube launcher is a variant of the rail launcher. Tube type launchers contain the missile in launcher tubes until the missile motor is ignited. The missile then fires from the tube in a manner similar to firing aircraft-mounted rockets [13].

### 2.4.3.2 Racks

Bomb racks are aircraft armament equipment items which provide for the suspension, carriage, and release of ordnance items from the aircraft. Most bomb racks are installed semi permanently on an aircraft and are referred to as parent racks. Bomb racks are generally classified as ejection or free-fall. A free-fall bomb rack allows the ordnance item to fall from the rack when all the requirements of the launch sequence have been satisfied, while release from an ejector-type bomb rack is accomplished by the firing of a cartridge actuated device which then ejects the item or items. Aircraft bombs, torpedoes, mines, and other stores are suspended either internally or externally by bomb racks. Bomb racks carry, arm, and release these stores. A bomb rack (BRU-12/A) is shown in Figure 2-14.

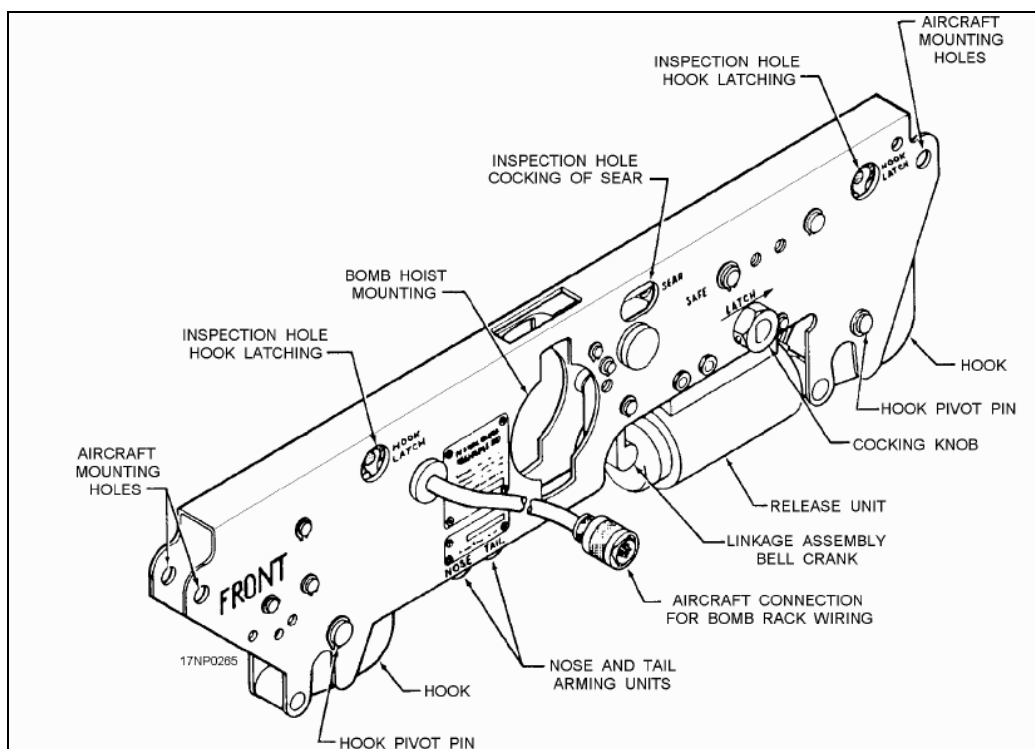

**Figure 2-14: BRU-12/A Aircraft Bomb Rack.**

When a weapon/store is loaded onto the bomb rack, the suspension lugs on the weapon/store engage the heel of the bomb rack suspension hooks. This causes the hooks to pivot up and engage the suspension lugs. The hooks are held in the closed position by sears. When the pilot initiates bomb release, an electrical signal is routed through the weapon system circuits to the bomb rack. This signal activates a solenoid that activates the release linkage in the bomb rack. This causes the suspension hooks to open, letting the weapon/store fall away from the aircraft.

Current suspension, arming, and releasing devices for aircraft require the use of associated electrical gear. This gear times the release of stores and rack selectors to control the pattern of store releases. Other units - select the desired arming of bomb fuzes. Each serves a definite purpose in accurately delivering weapons against the enemy. Wide variety of suspension equipment is used and designed to accommodate a certain maximum weight. The structural strength of the aircraft determines the maximum weight that may be suspended. The aircraft weight capacity per rack is usually less than rack design capability ([14], [15]). Maximum carriage value for bomb rack units may vary according to the distance between suspension lugs. Maximum carriage value is 1450 pounds for a 14-inch lug span and 5000 pounds for 30-inch one.

**2.4.3.3 Bomb Ejector Racks**

Bomb ejector racks differ from standard bomb racks. Ejection racks use electrically fired impulse cartridges to open the suspension hook linkage and eject the weapon/store. When in flight, a vacuum can be created under the fuselage and wings of the aircraft. In some cases, this vacuum will prevent the released weapon/store from entering the air stream and falling to the target. Physical contact between the weapon/store and the aircraft structure may result. This could cause damage to or loss of the aircraft. Bomb ejector racks eject the weapon/store from the bomb rack with sufficient force to overcome this vacuum and ensure a safe release. Various bomb ejector racks are shown in Figure 2-15.

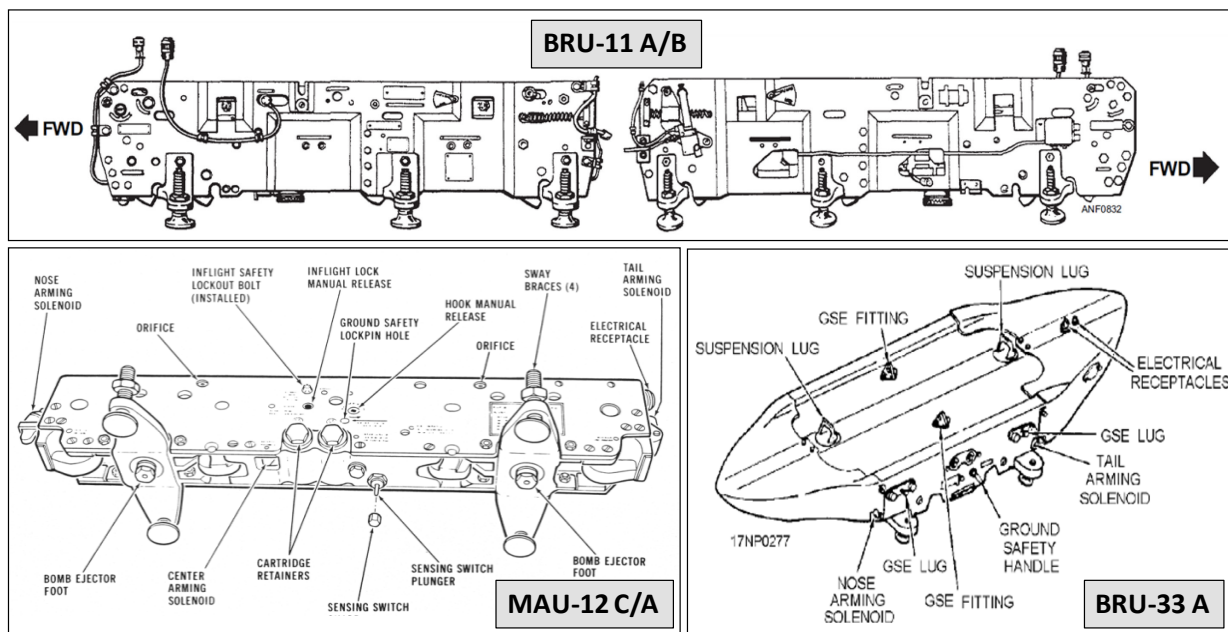

**Figure 2-15: Bomb Ejector Racks.**

**2.4.3.4 Pneumatic Bomb Ejector Racks**

To increase the reliability and the cost effectiveness of the bomb racks, the Pneumatic Bomb Ejector Racks (PBER) were developed. The PBER utilizes pneumatic ejection technology which ejects the stores using



compressed air as opposed to older systems which rely on pyrotechnic cartridges. A typical PBER is shown in Figure 2-16 [16].

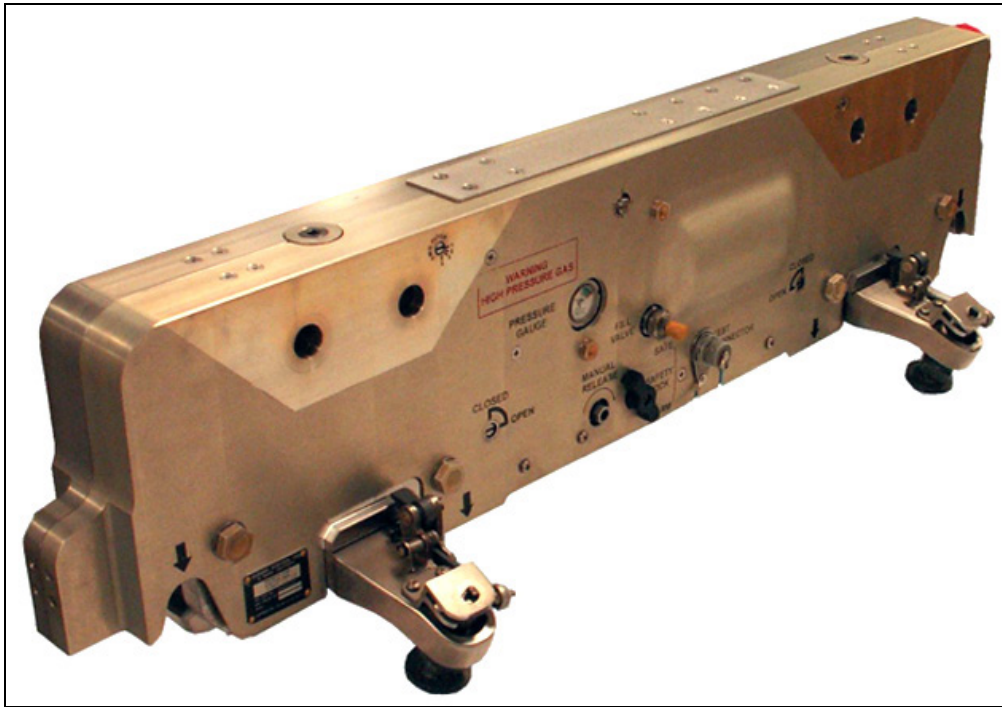

**Figure 2-16: A Pneumatic Bomb Ejection Rack.**

Pneumatic ejection technology ensures a much safer system which also requires significantly less logistical support, maintenance and repair than legacy systems and as a result the total cost of ownership is significantly reduced [17].

### **2.4.3.5 Multiple Bomb Ejector Racks**

The earliest multi-weapon carriage systems were used to increase the carriage capability (weapon load-out) of ballistic bombs. These types of carriers provided an extension to the main aircraft carriage system, duplicating the bomb rack and the fuzing connections for multiple bombs. A typical multiple ejector rack is shown in Figure 2-17. The advent of smart weapons has led to electronics being included in the carrier to convert the interface with a single aircraft electrical connector to multiple interfaces, one for each weapon [18].



**Figure 2-17: Multiple Ejector Rack Loaded Up with Three Air-to-Ground Munitions [19].**

Whilst a smart multi-weapon carriage system can increase the overall weapon load-out, this has implications for the aircraft systems integration activity. The aircraft now communicates with the carrier and not necessarily directly with each individual weapon on the carrier. The aircraft will therefore need to know exactly what is loaded on the carrier and at which station so that, for example, the correct navigation system offsets can be applied and target and fuzing data can be passed to the right weapon. Such a configuration will also increase the system data transmission delays, which could mean that the data received by the weapon is stale. In turn, this could have implications for the accuracy of the weapon when launched against a target [18].

The BRU-61/A carriage system (Figure 2-18) is the first pneumatic multi-stores carriage system to enter service with US aircraft. The BRU-61/A utilizes pneumatic ejection technology which ejects the stores using compressed air as opposed to older systems which rely on pyrotechnic cartridges and represents the latest design in pneumatic ejection systems [17].



**Figure 2-18: BRU-61/A Pneumatic Multi-Stores Carriage System Installed on A/C [20].**



## Chapter 3 – INTEGRATION CONCEPT

As with any system design, a structured, top-down approach is essential. However, for weapons integration, the higher level requirements will also include aeromechanical aspects such as the desired launch envelope, carriage life, the number of weapons that can be carried, influences of other weapon and store types to be carried on the same sortie, etc.

In relation to the top-level requirements for the capability to be delivered, there is a need to segment individual requirements to aircraft sub-systems. The segmentation process may use software-based requirements management tools, as these assist in validation and verification of the system implementation against the requirements. The actual segmentation will depend on the system architecture and is therefore aircraft-specific. However, the requirements could be segmented into, for example, mission-critical and safety-critical processes, navigation, targeting requirements, aerodynamic requirements, and so on.

At the lower system design levels, there is a need to understand the operation of the weapon and the data exchanges with the aircraft. This is documented in an Interface Control Document (ICD), which is agreed between the aircraft and weapon design organizations. The Society of Automotive Engineers (SAE) has published a standard (AS5609) for the format and definitions of the ICD. The ICD defines all information relevant to the integration such as mechanical attachments, electrical signal sets, data structures, timeline (a detailed temporal sequence of data and state transitions required for the aircraft to operate the weapon), environmental data, and aerodynamic data. Negotiation of the ICD can be a significant activity, particularly when a new weapon is being developed in parallel with integration to the platform.

Following implementation of the requirements in the aircraft sub-systems, integration testing will be undertaken in the Systems Integration Laboratory (SIL) located in Integration and Certification Directorates. Each country may have different organization and title for these directorates. Employing either weapon simulators or inert weapons with operational electronics, integration testing of all the sub-systems to control the weapon is executed in these directorates. Such testing identifies problems that need to be corrected during an iteration of the sub-system design and implementation.

Following successful systems integration on the ground, the complete system will be flight-tested, leading to the eventual live firing of weapons against representative targets.

What is commonly known as the systems engineering process is basically an iterative process of deriving/defining requirements at each level of the system, beginning at the top (the system level) and propagating those requirements through a series of steps which eventually leads to a preferred system concept. Depending on the maturity of the weapons and/or aircraft, there are six separate compatibility situations involved when authorization of a weapon on an aircraft is required that drives the scope of the Validation and Verification (V&V) and Test and Evaluation (T&E) activities. The six situations, in order of increasing risk, are:

- Adding “old” in-service stores to the authorized stores list of “old” aircraft;
- Adding “modified old/similar” stores to the authorized list of “old” aircraft;
- Adding “new” stores to the authorized stores list of an “old” aircraft;
- Adding “old” stores to the authorized stores list of a “new” aircraft;
- Adding “modified old/similar” stores to the authorized list of “new” aircraft; and
- Adding “new” stores to the authorized stores list of “new” aircraft.

Two of the vital tools that an aircraft store integration systems engineer should use to address all situations above are:

- Risk management of all the constituent elements of the system; and
- Experimentation and systems modeling at the necessary level of fidelity across the broad range of engineering, scientific and programmatic disciplines.

There exist many facilities for different levels of integration at weapon, hardware and software suppliers, aircraft manufacturers and Integration and Certification Directorate Facilities. Weapon and software suppliers integrate components into sub-systems in Avionic/Aircraft Integration Laboratories and SIL's prior to deliver to aircraft manufacturers. The objective is to ensure physical and functional compliance prior to sub-system installation. The Avionic/Aircraft Integration Laboratories and SIL's consist of a set of racks of armament and interfacing components or emulators, related architecture, instrumentation, processors and control stations. System integration tests may be conducted in the Avionic/Aircraft Integration Laboratories or SIL when required to support versions of flight test software.

The aircraft contractor conducts the aircraft system-level integration in their Avionic/Aircraft Integration Laboratories, mission equipment development lab or hot bench to ensure safe and effective integration. The aircraft contractor integrates the weapon and SMS system software and the aircraft Operational Flight Program (OFP). It is also important for them to substantiate that there is no degradation to other aircraft sub-systems and flight performance of both aircraft and pre-certified stores. The Government facilities, SILs and other labs test the development of Government Furnished Equipment (GFE) armament and GFE weapon integration.

The generalized objective of an integration program is composed of several phases. These phases can be stated as development, avionic integration, functional, evaluation, demonstration and performance.

Software and sub-system interfaces are developed during the development phase in the software engineering environments. Following this activity, integration tests are carried out to identify total system software and hardware functions in SILs. Finally, functional tests are carried out to identify hardware and software design and integration problems. After completing these three phases, one can optimize the system software, demonstrate specification compliance and perform performance tests with in the following three phases.

### 3.1 SYSTEMS ENGINEERING DURING INTEGRATION PROCESS

Systems engineering has evolved from a process focused primarily on large-scale defence systems to a broader discipline that is used in all kinds of project development. Systems engineering can be applied to any system development, so whether you are developing a household appliance, building a house, or implementing a sophisticated transportation management system, systems engineering can be used.

Systems engineering is an interdisciplinary approach that encompasses the entire technical effort, and evolves into and verifies an integrated and life-cycle balanced set of system people, products, and process solutions that satisfy customer needs [21]. It is an interdisciplinary, collaborative approach that derives, evolves and verifies a life-cycle balanced system solution, which satisfies customer expectations and meets public acceptability [22]. Systems engineering integrates all the disciplines and specialty groups into a team effort forming a structured development process that proceeds from concept to production or operation. Systems engineering considers both the business and the technical needs of all customers with the goal of providing a quality product that meets the user needs.

Note that this definition is very broad – it covers the project life cycle from needs definition to system disposal. It includes technical activities like requirements and design, as well as project activities like risk management and configuration management. Systems engineering provides a systematic process and tools that directly support project management [23].

In summary, systems engineering is:

- An interdisciplinary engineering management process that evolves and verifies an integrated, life-cycle balanced set of system solutions that satisfy customer needs to enable the realization of successful systems [24].
- A logical sequence of activities and decisions that transforms an operational need into a description of system performance parameters and a preferred system configuration.
- A profession, a process, and a perspective as illustrated by these three representative definitions.
- A discipline that concentrates on the design and application of the whole (system) as distinct from the parts. It involves looking at a problem in its entirety, taking into account all the facts and all the variables and relating the social to the technical aspect [25].
- Iterative process of top-down synthesis, development, and operation of a real-world system that satisfies, in a near-optimal manner, the full range of requirements for the system [26].

Since systems engineering has a horizontal orientation, the discipline (profession) includes both technical and management processes. Both processes depend upon good decision-making. Decisions made early in the life cycle of a system, whose consequences are not clearly understood, can have enormous implications later in the life of a system. It is the task of the systems engineer to explore these issues and make the critical decisions in a timely manner.

### **3.1.1 Fundamentals of Systems Engineering**

Systems engineering is a methodical, disciplined approach for the design, realization, technical management, operations, and retirement of a system [27]. It is a way of looking at the “big picture” when making technical decisions. In other words, systems engineering is a logical way of thinking.

Systems engineering is a holistic, integrative discipline, wherein the contributions of structural engineers, electrical engineers, mechanism designers, power engineers, human factors engineers, and many more disciplines are evaluated and balanced, one against another, to produce a coherent whole that is not dominated by the perspective of a single discipline. It seeks a safe and balanced design in the face of opposing interests and multiple, sometimes conflicting constraints.

The systems engineer must develop the skill and instinct for identifying and focusing efforts on assessments to optimize the overall design and not favor one system/sub-system at the expense of another. Personnel with these skills are usually tagged as “systems engineers”.

In summary, the systems engineer is skilled in the art and science of balancing organizational and technical interactions in complex systems.

Project management can be thought of as having two major areas of emphasis, both of equal weight and importance. These areas are systems engineering and project control. Figure 3-1 is a notional graphic depicting this concept [28].

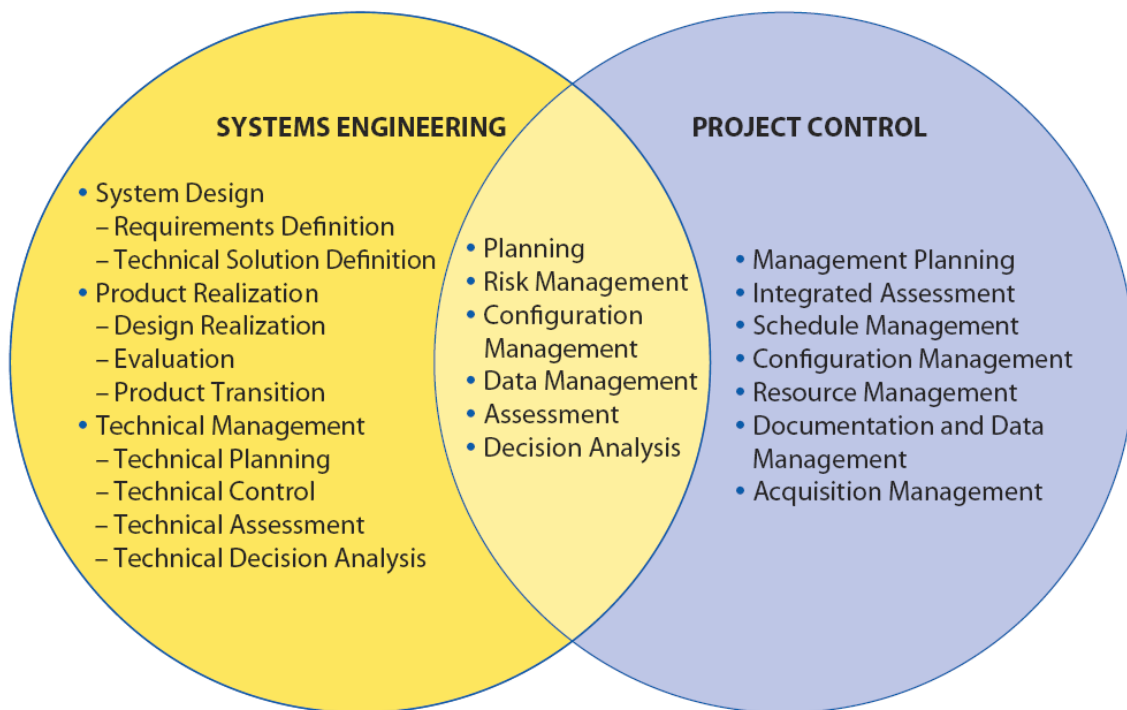

**Figure 3-1: Systems Engineering in Context of Overall Project Management.**

### 3.1.2 Systems Engineering and Traditional Engineering Disciplines

From the above definition, it can be seen that systems engineering differs from mechanical, electrical, and other engineering disciplines in several important ways.

First of all, systems engineering is focused on the system as a whole; it emphasizes its total operation. It looks at the system from the outside, that is, at its interactions with other systems and the environment, as well as from the inside. It is concerned not only with the engineering design of the system, but also with external factors, which can significantly constrain the design. While the primary purpose of systems engineering is to guide, this does not mean that systems engineers do not themselves play a key role in system design. On the contrary, they are responsible for leading the formative (concept development) stage of a new system development, which culminates in the functional design of the system reflecting the needs of the user. Systems engineering bridges the traditional engineering disciplines. Systems engineers must guide and co-ordinate the design of each individual element as necessary to assure that the interactions and interfaces between system elements are compatible and mutually supporting [29].

### 3.1.3 Systems Engineering Fields

Since systems engineering has a strong connection bridging the traditional engineering disciplines, it should be expected that engineering specialists look at systems engineering with a perspective more strongly from their engineering discipline.

The management support functions that are vital to systems engineering success such as quality management, human resource management, and financial management can all claim an integral role and perspective to the system development. These perceptions are illustrated in Figure 3-2 and additional fields that represent a few of the traditional areas associated with systems engineering methods and practices are also shown.

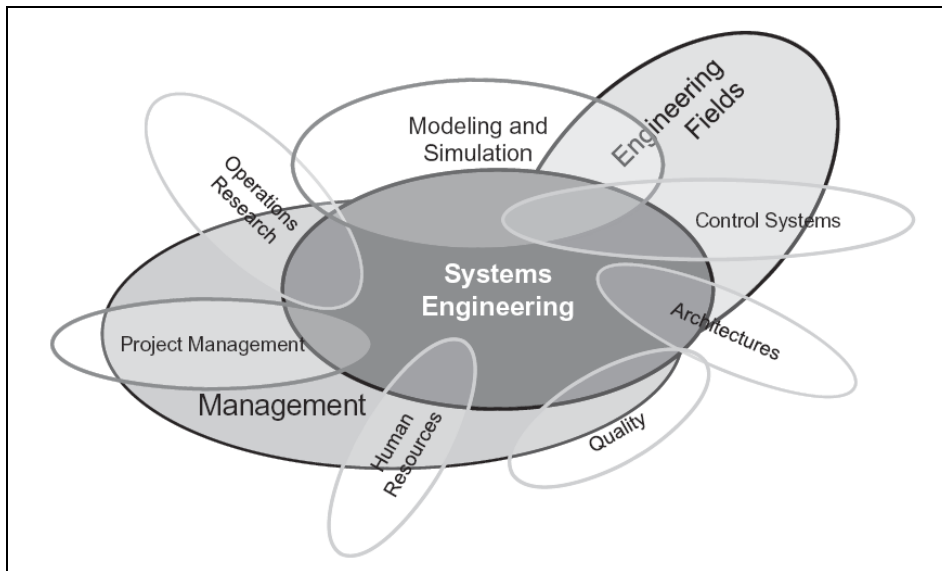

Figure 3-2: Examples of Systems Engineering Fields.

### 3.1.4 System Engineering Process

System engineering process is a logical sequence of activities and decisions that transforms an operational need into a description of system performance parameters and a preferred system configuration. As shown by Figure 3-3, the process includes: inputs and outputs, requirements analysis, functional analysis and allocation, requirements loop, synthesis, design loop, verification, and system analysis and control [30].

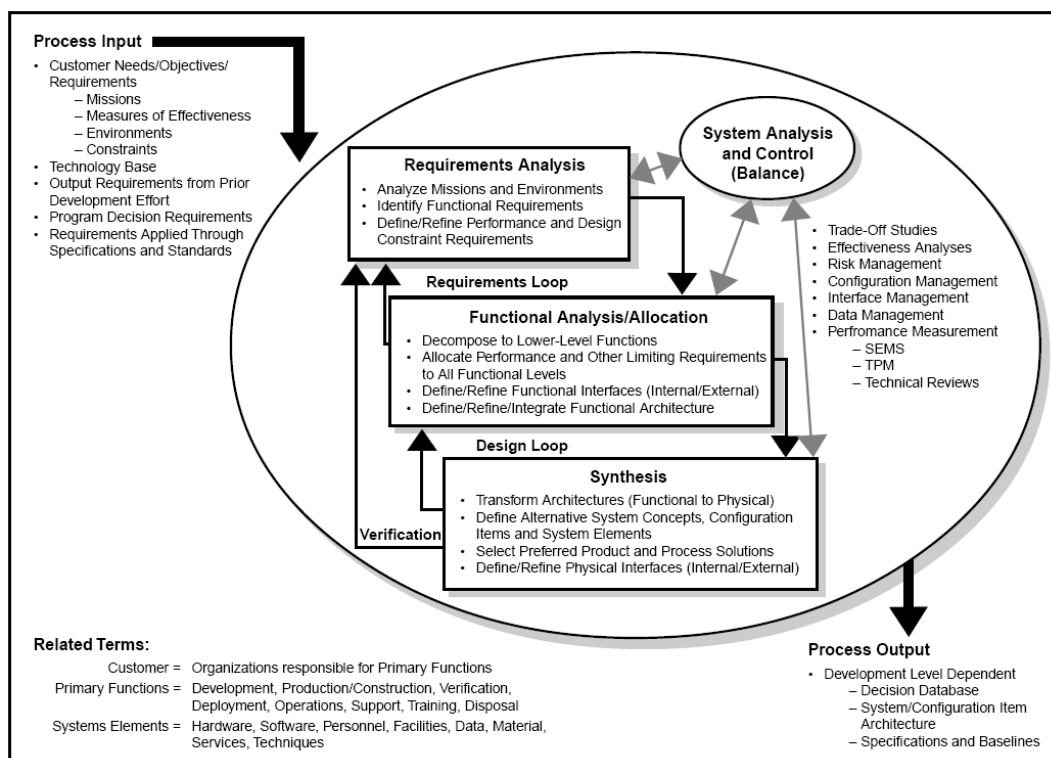

Figure 3-3: The System Engineering Process.

The process input shall include information necessary to support continued technical effort (includes results from technology validation and item verification) as well as initiation of a new phase of technical effort (includes new or updated customer needs, technology base data, outputs from a previous phase, and program constraints).

The systems engineering process of requirements analysis, functional analysis/allocation, synthesis, and systems analysis and control shall be employed progressively throughout the effort to achieve contractual objectives and to define requirements, designs, and solutions for the system life cycle. Finally, customer needs, objectives, and requirements in the context of customer missions, utilization environments, and identified system characteristics shall be analyzed to determine functional and performance requirements for each primary system function. Requirements analysis shall be conducted iteratively with functional analysis to develop requirements that depend on additional system definition and verify that people, product, and process solutions can satisfy customer requirements.

### **3.1.4.1 Functional Analysis/Allocation**

A functional architecture shall be defined and integrated to the depth needed to support synthesis of solutions for people, products, and processes and management of risk. Functional analysis/allocation shall be conducted iteratively for defining successively lower-level functions required to satisfy higher level functional requirements and to define alternative sets of functional requirements with requirements analysis to define mission and environment driven performance and to determine that higher level requirements are satisfied.

### **3.1.4.2 Synthesis**

Design solutions for each logical set of functional and performance requirements in the functional architecture shall be defined and integrated as a physical architecture. Synthesis shall be conducted iteratively with functional analysis/allocation to define a complete set of functional and performance requirements necessary for the level of design output required. Requirements analysis shall be used to verify that solution outputs can satisfy customer input requirements.

### **3.1.4.3 Design**

The outputs from synthesis shall describe the complete system, including the interfaces and relationships between internal and external items. The information for establishing and updating applicable functional, allocated, and product baselines, drawings and lists, interface control documentation, technical plans, life cycle resource requirements, procedural handbooks and instructional materials and documentation of personnel task loading shall be developed.

### **3.1.4.4 Design Verification**

The performing activity shall progressively verify that product and process designs satisfy their requirements (including interfaces), from the lowest level of the current physical architecture up to the total system.

### **3.1.4.5 Systems Analysis and Control**

The performing activity shall measure progress, evaluate alternatives, select preferred alternatives, and document data and decisions used and generated. Systems analyses shall include trade-off studies, effectiveness analyses/assessments, design analyses to determine progress in satisfying technical requirements and program objectives. It shall provide a rigorous quantitative basis for performance, functional, and design requirements according to these studies. Control mechanisms shall include risk management, configuration management, data management, performance-based progress measurement, Technical Performance Measurement (TPM), and technical reviews.



#### **3.1.4.6 Trade-Off Studies**

Desirable and practical trade-offs among user requirements, technical objectives, design, program schedule, functional and performance requirements, and life-cycle costs shall be identified and conducted. Trade-off studies shall be defined, conducted, and documented at the various levels of the functional or physical architecture in enough detail to support decision-making.

#### **3.1.4.7 Synthesis Trade-Off Studies**

Synthesis trade-off studies shall be conducted to:

- Support decisions for new products and materials selection;
- Establish system configuration and assist in selecting system concepts, designs, and solutions;
- Examine proposed changes and alternative technologies;
- Evaluate environmental and cost impacts of materials and processes, and evaluate alternative physical architectures to select preferred products and processes; and
- Select standard components, techniques, services, and facilities that reduce system life-cycle cost and meet system effectiveness requirements.

#### **3.1.4.8 System/Cost Effectiveness Analysis**

A systems analysis effort shall be planned and implemented as an integral part of the systems engineering process. This effort shall include development, documentation, implementation, control, and maintenance of a method to control analytic relationships and measures of effectiveness. System/cost effectiveness assessments shall be used to support risk impact assessments.

### **3.1.5 Risk Management**

Risks shall be assessed for products, processes (e.g. process variability), and their interrelationships. Risk shall also be assessed for contractually identified variations, uncertainties, and evolutions in system environments. The risk management program shall be conducted to:

- Identify potential sources of technical risk;
- Quantify risks, including risk levels, and their impacts on cost (including life-cycle costs), schedule, and performance;
- Determine sensitivity of interrelated risks and alternative approaches to handle moderate and high risks; and
- Take actions to avoid, control, or assume each risk and ensure risk factors.

### **3.1.6 Configuration Management**

The configuration of identified system products and processes should be managed by suitable configuration management activities. This effort shall include configuration:

- Identification, including the selection of the documents;
- Control, including the systematic proposal, justification, evaluation, co-ordination, approval, or disapproval of all proposed changes;
- Status accounting, including the recording and reporting of the information needed; and
- Audits, including verification that the Configuration Item (CI) conforms.

### 3.1.7 Interface Management

All internal and external interfaces within their contractual responsibility shall be managed and controlled carefully in system engineering process. The design compatibility of external and internal engineering interfaces shall be delineated as interface requirements in their specifications. Interface controls shall be established, co-ordinated, and maintained for interface requirements, documents, and drawings. They shall also include all applicable performing activity, vendor, and sub-contractor contract items and tasking activity furnished equipment, computer programs, facilities, and data. Interfaces shall be controlled to ensure accountability and timely dissemination of changes.

### 3.1.8 Data Management

An integrated data management system shall be established and maintained for the decision database to:

- Capture and organize all inputs as well as current, intermediate, and final outputs;
- Provide data correlation and traceability among requirements, designs, solutions, decisions, and rationale;
- Document engineering decisions, including procedures, methods, results, and analyses;
- Be responsive to established configuration management procedures;
- Function as a reference and support tool for the systems engineering effort; and
- Make data available and sharable as called out in the contract [31].

## 3.2 MANAGING COMPLEXITY WITH MODELS

System models allow you to capture complexity at many different levels, including system-of-systems, system itself, sub-system, and component levels. Models can take many different forms. The right model can show you what you need without extra detail. Considering the classical development models, the most established are the Waterfall Model, the V-Model, and the Spiral Model. All these models concern grouping of development activities and the flows of information and time.

### 3.2.1 The Waterfall Model

The Waterfall Model (Figure 3-4), provides the following information [32].

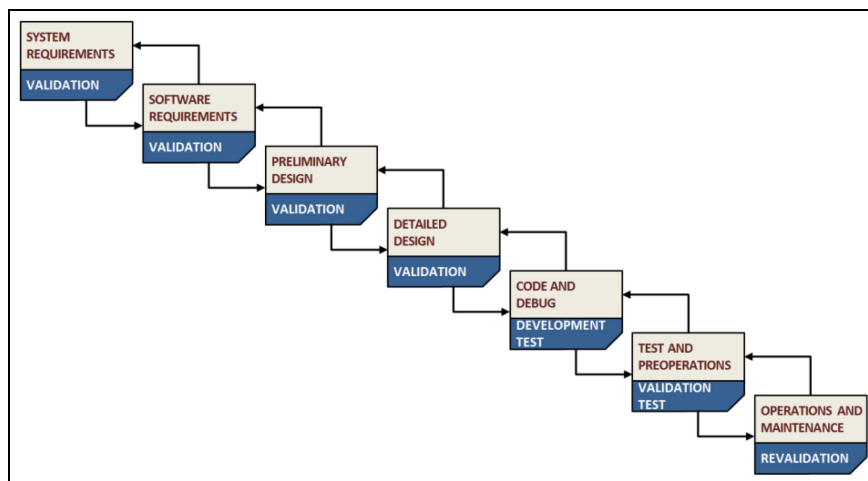

**Figure 3-4: The Waterfall Model in a Software Development Project.**



The development phases in the life cycle are ordered in time: a linear ordering of, roughly, requirements analysis, design, coding, testing and maintenance; these are depicted as boxes. Activities are associated with the boxes. Transitions from one phase to another are drawn as arrows; the arrows express information flow and time ordering.

Validation occurs in each phase: the output of a development phase is validated against the input of that phase. In the Waterfall Model, validation is included as a box at the bottom of the phase box. This suggests that validation occurs at the end of the activities in a box.

As later phases might lead to reconsidering earlier ones, there are feedback arrows. Boxes identify a development phase and arrows indicate the time order. Implicitly, there is also information flow between phases: activities in a phase use information from the previous phase. A problem is that because of the feedback arrows, the time order and the information flow are quite complex. Especially for validation activities, neither the timing nor the information flow is very detailed or explicit.

### 3.2.2 The V Development Model

Over the past 20 or so years, experts in complex system design have developed and refined what's known as the V-Model of the systems engineering process (see Figure 3-5). The V-Model is a graphical representation of a series of steps and procedures for developing complex systems.

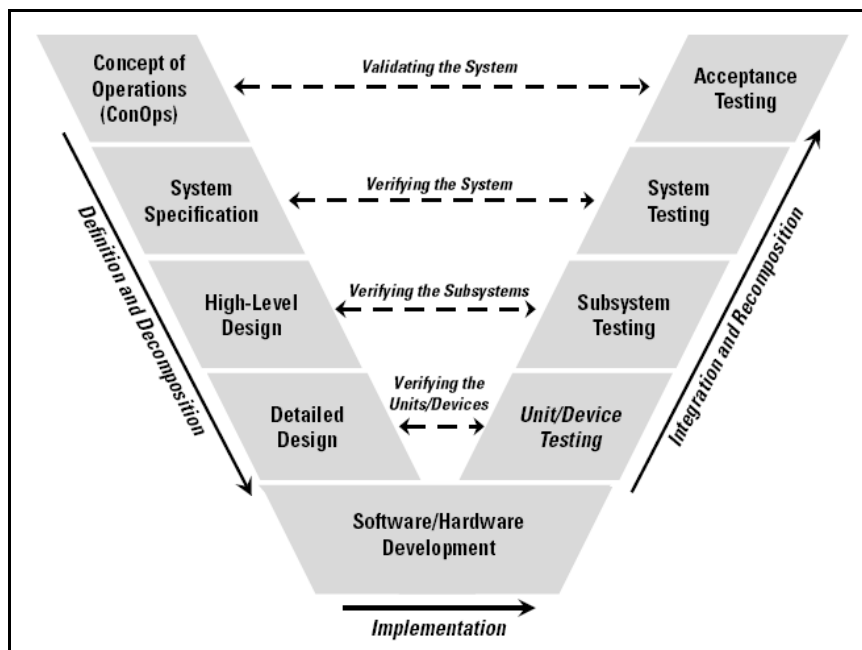

Figure 3-5: The V Development Model.

Tracing the “V” from left to right, you execute the systems engineering process in a series of steps [33], as follows:

- **Concept of Operations (ConOps):** Identify and document key stakeholder needs, overall system capabilities, roles and responsibilities, and performance measures for system validation at the end of the project.
- **System Specification:** Map out a set of verifiable system requirements that meet the stakeholder needs defined during ConOps.

## INTEGRATION CONCEPT

- **High-Level Design:** Design a high-level system architecture that satisfies the system requirements and provides for maintenance, upgrades, and integration with other systems.
- **Detailed Design:** Drill down into the details of system design, developing component-level requirements that support within-budget procurement of hardware.
- **Software/Hardware Development:** Select and procure the appropriate technology and develop the hardware and software to meet your detailed design specs.
- **Unit/Device Testing:** Test each component-level hardware implementation, verifying its functionality against the appropriate component-level requirements.
- **Sub-System Testing:** Integrate hardware and software components into sub-systems. Test and verify each sub-system against high-level requirements.
- **System Testing:** Integrate sub-systems and test the entire system against system requirements. Verify that all interfaces have been properly implemented and all requirements and constraints have been satisfied.
- **Acceptance Testing:** Validate that the system meets the requirements and is effective in achieving its intended goals.

### 3.2.3 The Spiral Model

The Spiral Model (see Figure 3-6), addresses the problem that both Waterfall and V-Model suffer from an unrealistic modeling of timing of phases.

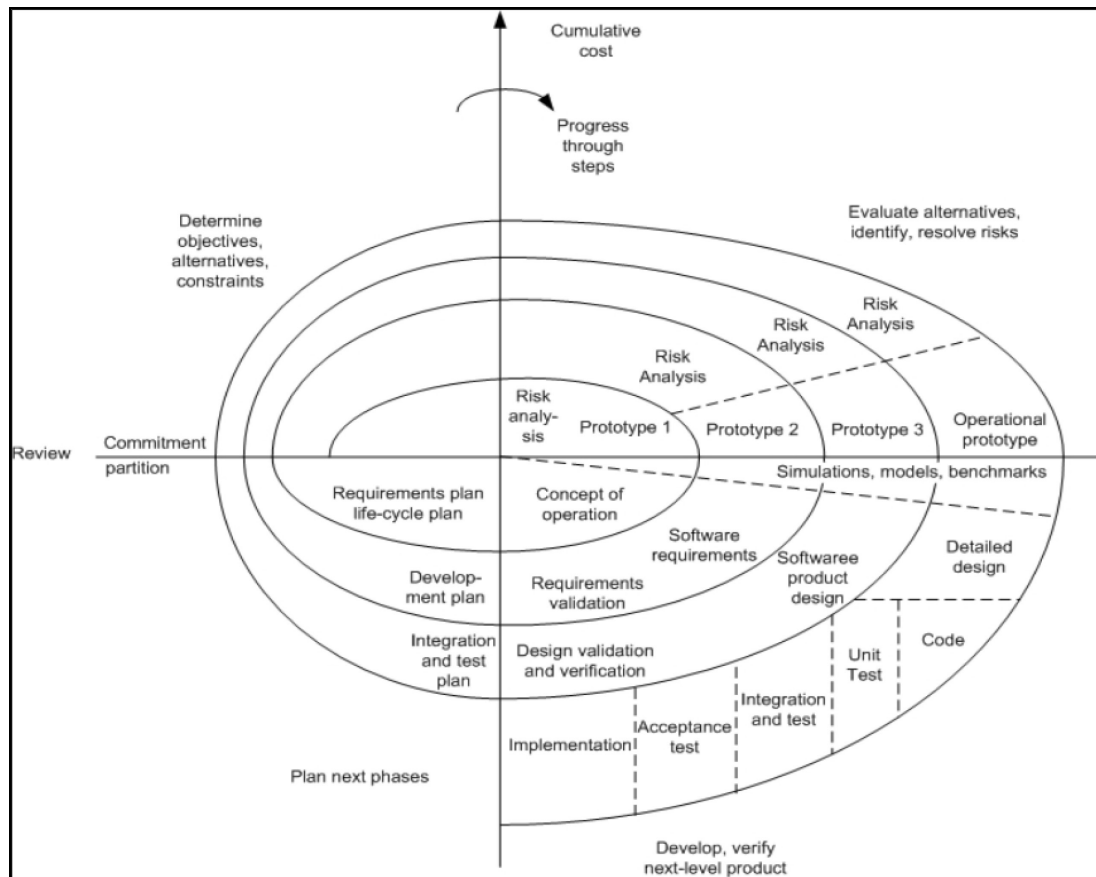

Figure 3-6: The Spiral Model.

It recognizes that development is often iterative and graphically depicts this by providing multiple instances of the phases from these models and ordering these as a spiral. Thus, a more realistic representation of timing is provided. The Spiral Model can then be viewed as one of the possible timing models for the Waterfall Model.

The drawback of detailing time is that now the complexity of the mix of information and time flow becomes even larger than before: information flow arrows would be duplicated wherever phase duplication occurs because of the time detailing [34].



## Chapter 4 – ENGINEERING WORK

The aircraft/stores integration process requires analysis, simulations, ground and flight-testing activities to be executed together. These activities include:

- Structural and aerodynamic analysis to determine safe carriage, employment, jettison envelope limits;
- Aircraft/stores mechanical and electrical interface tests;
- Flight tests to obtain/generate the data needed for safe escape and ballistic accuracy verification, aircraft/stores compatibility;
- Operational Flight Programs update (OFPs);
- Technical Orders preparation (TOs); and
- Preparation of supporting and operational documents, such as safe upload and download procedures.

The weapon and its integration/interfaces with the aircraft, both hardware and software, should be clearly defined and tracked during the integration process. An operational concept should be provided that describes the intended implementation and utilization of the weapon and platform. The operating procedures that govern the handling, loading, and operational engagement of the weapon system should be provided or updated during both design and integration phases. The focus of the procedures is typically centered on safety, efficiency and effectiveness. Functional diagrams should be provided that show and describe all components of the entire weapon system/sub-system. These documents identify each item of the system/sub-system and include the functional relationship and purpose of the items. Weapon geometric data, mass properties and interface documentation are certainly used during the integration activities. The interconnections to systems, such as hydraulic, pneumatic, and electrical, should be shown. Structural attachment details must be provided and all loaded joints clearly shown. Mounting details depicting the equipment to bracket, pallet, or stores rack attachments to the aircraft structure are needed. Description of suspension and release equipment should include impulse cartridges, ejection velocities, orifices, arming unit type and location, and inspection criteria. All electrical schematics and wire diagrams should be provided.

Equipment installation and arrangement drawings that show the location of all major items of weapon equipment on the aircraft must be provided. Moreover, three-view drawings of the weapon installed, including dimensional information, which shows required clearances between stores, stores to aircraft components, and stores to ground should be prepared. Any special installation or servicing requirements, such as boresight equipment and alignment procedures should be provided.

Drawings, sketches and block diagrams are required that describe the location and interconnection of the weapon components and flight test instrumentation throughout the aircraft as well as the routing, support and protection of associated wires, wire harnesses and cables. Schematics and wire diagrams are also required, which should include interconnections among the new or modified equipment as well as with existing aircraft equipment including electrical power sources. Failure analyses should be provided for the interfaces with existing aircraft electrical circuits. Detailed requirements are the identification of shielded wires, over braids, shield and over braid terminations, points of electrical bonding, wire types used, wire gauges, wire temperature ratings, details regarding harnesses and bundles of wires and cables, circuit breakers (including their ratings and locations), and power bus identification. This data will be used to evaluate E3 integrity as well as evaluate adequacy of circuit protection against electrical faults in the newly added/modified equipment.

Software (OFP) documents or updates to the existing documents must be submitted that are necessary for the weapon operation and safety, and its effective safe aircraft integration. If other aircraft sub-systems are

affected by the integration, the interfacing system documents should be updated. The documentation should describe the architectural design and detailed design necessary to implement the software. The Software version description should identify and describe the software version for each Computer Software CI. Some sort of problem change reports should log each software, hardware, and documentation problem found during system integration testing, the proposed solution and corrective action taken.

If it is necessary work with the contractor as a weapon designer/producer of the weapon, CFE weapon design data should be provided when CFE weapon equipment or modification of GFE are required. GFE that is required as part of the weapon sub-system design and its installation should be defined and planned/ordered in a timely manner for the program.

Analyses and simulations are used for a variety of purposes including program reviews, airworthiness release, safety-of-flight, and full integration activities. The selection of analyses and simulation requirements is highly tailorable to the nature, complexity and risk of the new or modified weapon.

Electrical loads analysis data should be prepared for the weapon modifications using MIL-E-7016 [35] as a guide. The purpose of the analysis is to demonstrate that adequate electrical power is available for the various modes of operation of both the weapon systems and the aircraft. Results of the analysis may be presented as an update to an existing electrical load analysis that has been approved by the airworthiness authority. In the event the contractor is not the author of the baseline report and/or the modifications are relatively minor, then the update may be submitted as a report with reference to the existing electrical loads analysis (a formal revision to the report may not be practical). In the event flight test instrumentation is also being installed on the test aircraft, then the update must include such equipment for as long as that equipment is installed on the aircraft. Finally, the baseline report may not be up-to-date; consequently, updates may be required to better represent the aircraft configuration that is being modified.

The human factors analyses and studies are typically conducted. This analysis reviews the existing task analysis for tasks affected by the weapon integration and new tasks required for the integration. The analysis is performed for all mission phases and places special emphasis where ground crew, operators' and maintainers' task loadings and co-ordination requirements approach saturation. Appropriate compromise and simulation studies to evaluate and optimize control display relationships are normally conducted. The impact of the weapon system upon crew vision, night vision, night-vision goggles and night-vision sensors needs to be analyzed.

Environmental analyses/tests should be tailored and conducted according to MIL-STD-810 [36]. The environmental tests that are imposed should consider the aircraft's expected operational environment in which the weapon will be expected to perform.

The weight and balance analysis should be conducted for the new or modified weapon system and its installation. Tables should include the weights, moments of inertia, and c.g. for weapon, as well as empty weights, gross weights, and c.g. for the aircraft with the weapon installed.

The structural integrity analyses should be conducted, for the newly designed or modified components and installation; loads and stress analysis is conducted on the weapons, internal and external stores, mounts/launcher, and the aircraft backup structure. It should be performed for all critical conditions throughout the aircraft/weapon operational envelope, including take-off and landing, jettison, and firing conditions. This analysis should consider the structural loading effects of the weapon on the aircraft and support structure and the effects of the aircraft and support structure on the weapon. The analysis should also include hang fire conditions. Crashworthiness analysis is conducted for the mounting of any equipment in the cabin, cockpit, external store stations or elsewhere on the aircraft. Special attention should be given to any potential occupant strike hazard from sighting equipment or emergency egress blockage. Any crashworthiness degradation to the aircraft or crew troops, due to the weapon installation, must be prevented or approved by

the Government. A fatigue substantiation report is typically provided. It defines the impact of the new or modified weapon sub-system (including installation) on component fatigue lives. The fatigue assessment must substantiate that the aircraft's existing fatigue capability has not been degraded.

A dynamic analysis is performed to determine the fundamental dynamic properties of the installed weapon system. These properties should include as a minimum:

- The resonant frequencies, damping, and mode shapes;
- The forced response of the installed system with the forcing frequencies of the host equal to the primary forcing frequencies of  $1P$ ,  $nP$ ,  $2nP$ , and  $3nP$  ( $n$  = number of rotor blades,  $P$  = rotor rotational frequency); and
- The installed system dynamic effect on both the weapon and host system.

The analysis may include a Resonance Assessment Profile modal survey to determine if harmonic vibrations could result in mounting failure. It is conducted using an instrumented hammer to determine the natural frequencies of the object and spectral analysis of the response.

An engine ingestion analysis is conducted to determine what effect the weapon exhaust gases (if it is) and solid debris have on engine performance throughout the flight envelope of the aircraft. The analysis should include any engine inlet temperature and pressure distortion effects and the effects of ingestion of propellant combustion products and debris generated by weapon firing. The engine and drive-train performance transients generated by the above conditions are estimated. A gas plume impingement analysis is conducted to determine the effects of the weapon sub-system exhaust gases and solid debris on the air platform.

Analysis of the impact of the weapon armament systems on the air vehicle's sensor systems shall be executed including sensor degradation due to blast pressure, vibration, flash smoke and debris.

The concerns for avionics are possible obscuration or distortion of antenna performance and their subsequent effect on communication, navigation, and other avionics performance. Analysis, modeling and simulation, and/or aircraft system-level testing may be required.

An analysis is conducted to show that there is sufficient clearance between the fuselage of the aircraft and the weapons sub-system, store trajectory, directed energy weapon beam path, weapon ejection clearance, and debris trajectories throughout the flight envelope of the aircraft. Trajectory clearance between individual munitions must insure they do not collide during or after launch.

Along with the launching of weapon, jettison is an element of "safe separation" and affects aircraft safety. The jettison analysis determines the safe jettison flight envelope for all droppable stores. The analysis is conducted as a predictive tool in advance of jettison flight tests and identifies the conditions that need to be flight tested. The analysis minimizes the scope, risk, cost and schedule of the jettison flight tests.

A safe arm and safe escape analysis should be performed to ensure that the aircraft will not be adversely affected by the debris caused by the explosive capability of the weapon. Safe arming is the selection of a minimum safe arming distance or fuze arm time setting that will provide the delivery aircraft acceptable protection from munition fragmentation if early detonation occurs. Safe escape is the set of flight conditions (altitude, speed and engagement range) that will provide the delivery aircraft acceptable protection from munition detonation downrange. The analysis should evaluate warhead debris traveling back towards the launch aircraft and calculate the probability of debris hitting the aircraft during the entire firing envelope. Firing restrictions might have to be imposed on the aircraft engagement conditions (such as altitude, airspeed, maneuver and range to target) necessary to attain safe escape criteria. The safe arm and safe escape analysis for high-explosive munitions is usually supported by fragmentation characteristics data gained from



ground firings in a static arena test. The safe arm and safe escape analysis should consider munitions functioning within design specifications as well as potential munition failure modes.

An accuracy firing analysis, including lethality as required, should be conducted for each new weapon or weapon modification that affects accuracy and lethality. The analysis is usually supported by modeling and simulation. It should analyze the weapon, its aircraft integration, error budgets and the “end-to-end” fire control from the sensors detecting the target to the munitions hitting and killing the target. The analysis should include fire control timelines. The Government usually provides operational scenario descriptions to the contractor in order to assess fire control modeling and simulation. They identify the target, and ownship flight conditions/maneuvers to be assessed. The accuracy firing analysis is intended to supplement aircraft live fire tests in order to substantiate compliance with weapon accuracy/lethality requirements. As such, the analysis and supporting simulation help reduce the scope, cost and schedule of the firing-flight survey and demonstration. Even if there are no quantified accuracy requirements in the aircraft specification, the Government may require the contractor to determine the accuracy through analysis, simulation and/or test. As a result, user will be able to determine how to safely and tactically deploy the system. The accuracy firing analysis also supports the preparation of an accuracy/lethality report upon completion of aircraft flight firing tests. The report uses the analyses, simulations, and firing tests to substantiate that the accuracy and lethality requirements have been met.

A missile/rocket launch transient analysis should assess the potential interaction of the aircraft, launcher and missile/rocket during the launch phase. The purpose of the analysis is to substantiate that there is little or no risk of an unsafe separation from the aircraft or risk of an errant missile rocket that can exceed the test site’s surface danger zone. The analysis should include, but not be limited to, the aircraft’s natural and induced environment on the munition at launch, aircraft launch constraints and data latency, store payload configurations, structural stiffness of the aircraft/stores system (aircraft, weapon pylon, store rack, munition, etc.), free play between store and aircraft, and transient effects on the munition’s guidance and control sub-system. In addition to aircraft safety, separation acceptance criteria also require that the transient store motions do not unacceptably degrade the weapons ability to perform its mission.

Aircraft combat survivability is the capability of an aircraft to avoid or withstand a man-made hostile environment. Susceptibility (avoid being hit) and vulnerability (withstand if hit) are sub-sets of aircraft combat survivability. This analysis must substantiate that the aircraft’s susceptibility and vulnerability capabilities have not been degraded.

An analysis is conducted that describes the methodology for preventing the loss or capture of classified data and weapons codes due to air vehicle or weapon malfunction. Examples of protection include automatically making the data unclassified when the aircraft is powered down and destroying classified data upon crash impact or at the pilot’s discretion. The weapon, its installation and operation must be in compliance with the relevant model aircraft’s security classification guide.

Reliability, Availability, and Maintainability (RAM) analysis is conducted to assess tracking to contract RAM requirements and to determine impacts on performance, of failure, safety, mean down-time and overall availability. It is prepared and updated during the weapon program using contractor predictions, estimates and qualification analysis or test data. In addition to the weapon basic design and aircraft integration, consideration should be given to parts interchangeability, durability, boresight (alignment, retention and equipment calibration), environmental test results, lubrication, fouling, capability for sustained firing, mount compatibility, recoil effects, drop tests and transportation. Any special tool or devices required are normally identified and assessed in the RAM analysis. The RAM analysis typically conducted in conjunction with a failure modes, effects, and criticality analysis.

An armed aircraft should have the capability to launch its weapons throughout the operational flight envelope, up to the capability of the weapon. However, weapon safe firing envelopes must be established to

restrict weapon firing to those aircraft maneuvers assessed to be safe. The safe firing envelope analysis, simulation must assess whether the weapon trajectory meets requirements for clearance with the aircraft's fuselage. Safe firing envelopes for the same weapon integrated on different model aircraft will most likely be different. The weapon system safe firing envelopes are determined and verified through a combination of analysis, simulation, laboratory tests, ground tests, and flight tests. Any other aircraft maneuver limitations for weapons engagements should be determined. The safe firing envelope analysis is conducted in conjunction with the weapon inhibits, limits and interrupts analysis.

Performance weapon inhibits, limits and interrupts analysis shall be established to allow the crew to fire within performance constraints such as when the munition(s) are most likely to hit the target. Safety weapon inhibits, limits and interrupts analysis is designed to prevent the aircrew from firing under an unsafe condition.

Component qualification ensures that the components meet or exceed the specified performance. Qualification tests should be performed on production or near production hardware. Performing qualification at the component level may be the only practical level at which a certain performance characteristic can be demonstrated. This is particularly true for tests requiring the use of laboratory equipment that could not practically accommodate a sub-system or system. Component qualification requirements are based on the criticality of their application in a specific air vehicle design and on the anticipated environmental conditions to which the component will be subjected. Component qualification tests are categorized as functional tests, structural tests, endurance tests, and environmental tests. Functional tests involve the demonstration of specified performance requirements and operational characteristics. Structural tests demonstrate the structural integrity of a component prior to its installation in the air vehicle. For critical dynamic components, determination of the service life based on fatigue loads is the basis for qualification. Endurance tests show the life adequacy of components subject to wear or deterioration with use. Environmental tests demonstrate that the equipment can be properly stored, operated and maintained in the anticipated environmental conditions.

Prior to the start of aircraft ground and flight tests, the weapon and fire control sub-systems must go through laboratory and hot bench tests to validate critical component and software parameters, as well as sub-system hardware and software integration. The purpose of this testing is to determine if all system-level requirements have been satisfied and to uncover problems which cannot be evaluated by testing up through the Computer Software CI or Hardware CI levels. There might be an overlap between sub-system integration and system integration tests. System integration test is the final level of integration that supports the aircraft ground and flight test. Integration involves evaluation of interfaces within the weapon and fire control, and with other aircraft sub-systems. All anomalies are tracked until they are resolved and closed. Integration involves many types of interfaces including:

- Software to software;
- Hardware to hardware; and
- Hardware to software.

Ground tests encompass all items requiring verification prior to the flight tests. In general, form, fit and function tests are conducted on the installed weapon system, including fire control. The ground tests help to minimize flight test risk and increase the likelihood of good performance during flight test. The ground tests will also serve to verify the analyses and may occur either on or off the aircraft. Off-aircraft testing might be conducted in simulators, hot benches or mock-ups.

Flight testing should be in accordance with a test plan approved by the Government and should follow the guidelines of an airworthiness release issued by the Government. Flight tests are conducted within the design operational flight envelope. Sufficient tests, analyses and weapon demonstrations are conducted to substantiate safe and satisfactory weapon sub-system operation over the range of flight and environmental conditions, and to verify the analytical and ground test results. Test aircraft are instrumented to collect data

for safe conduct of the tests, troubleshooting problems during the tests, and post-test evaluation of safety and performance.

Flight test instrumentation consists of sensors and data transmitting, receiving, displaying and recording equipment. The test instrumentation should be sufficient to record appropriate weapon, and aircraft data to establish qualification test compliance. The instrumentation and data analysis methods should be defined in the test plan as mentioned above.

#### 4.1 AIRCRAFT/STORES COMPATIBILITY WORK FLOW

Store integration projects should be planned in such a way that it should fulfill all project requirements in a given schedule in different design stages.

Generally integration projects consist of external store certification and avionics (software) integration tasks. But some integration scenarios involve mechanical and electrical modifications on aircraft also. The need for modification on aircraft may arise from the specific interface requirements of the store and/or instrumentation requirements for on-board ground and flight tests. A typical preliminary design workflow covering integration, certification and aircraft modification tasks is given in Figure 4-1. As can be seen in the figure, main input for preliminary design is the requirement set defined in System Requirement Review (SRR) phase. But design process should also answer the requirements that will come from ground and flight test instrumentation.

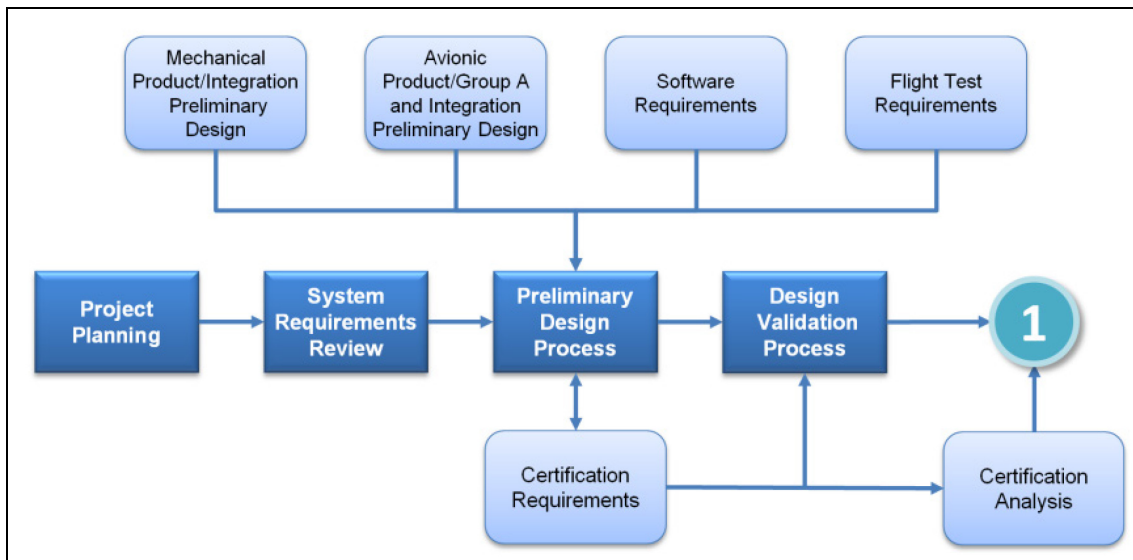

Figure 4-1: Preliminary Design Process.

After the validation of preliminary design phase, a detailed design process is executed. Stages of detailed design process are given in Figure 4-2. Detailed studies on instrumentation, software development, mechanical and avionic integration are executed in this phase.

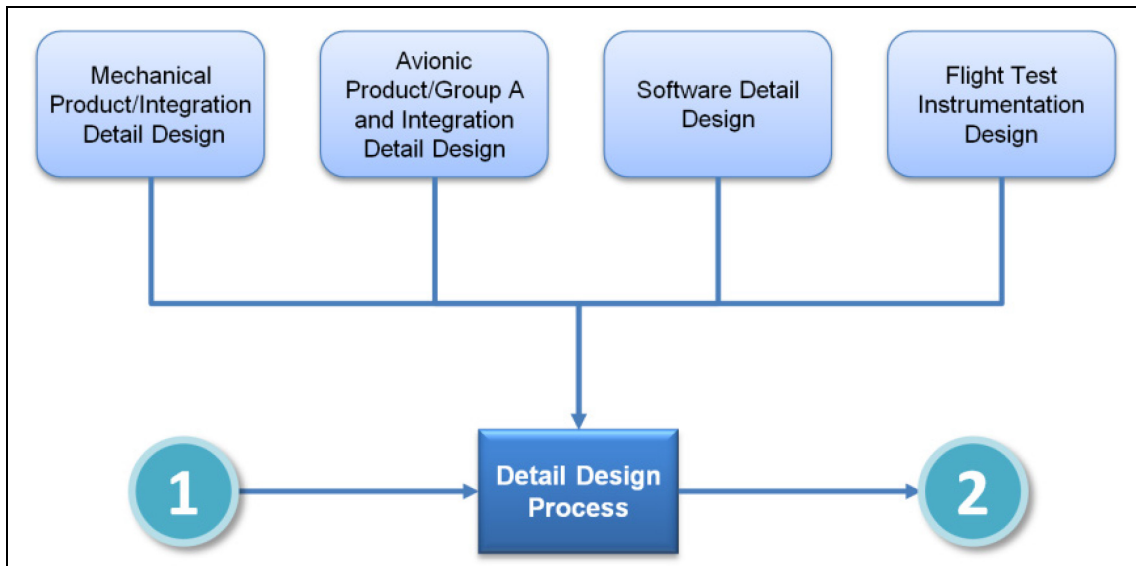

Figure 4-2: Detail Design Process.

Completing the detailed design phase, production and integration activities are executed in which SIL tests and flight test instrumentations are carried out as given in Figure 4-3.

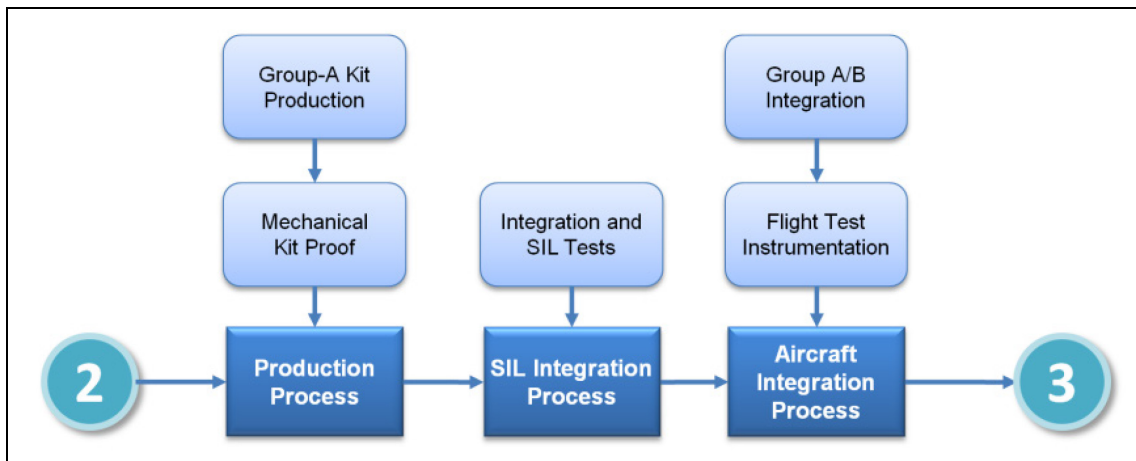

Figure 4-3: Production / Integration Process.

Finally, ground and flight tests are executed and related documents are prepared as given in Figure 4-4.

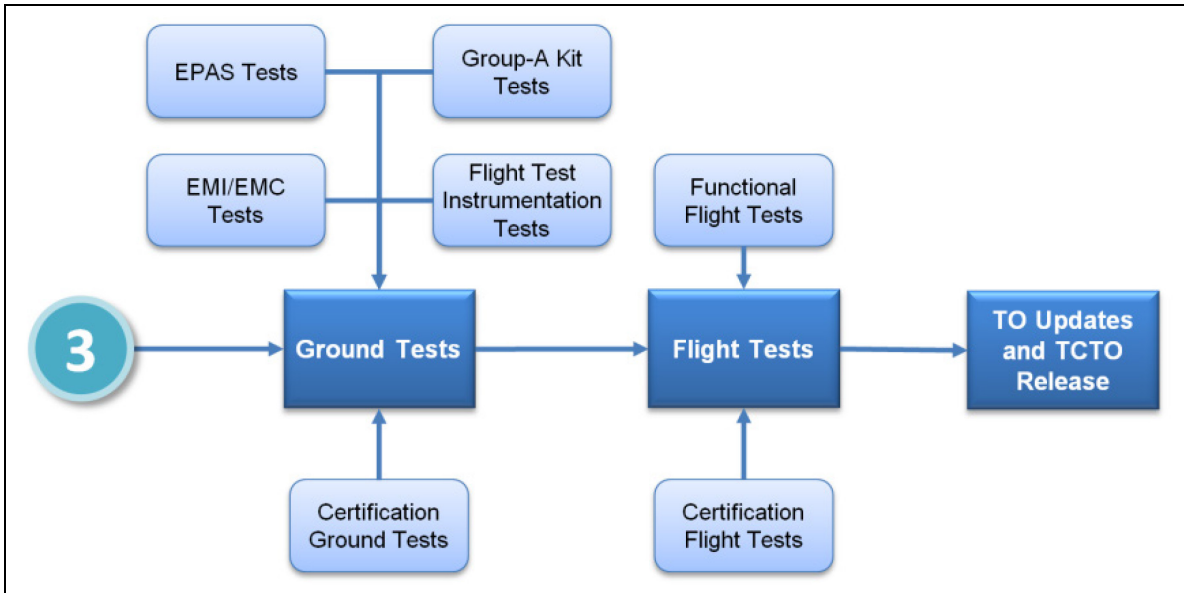

Figure 4-4: Test / Documentation Process.

## 4.2 AVIONICS INTEGRATION

### 4.2.1 Systems Integration

System integration is a systems engineering process which involves the incorporation of sub-systems into one system. These sub-systems include avionics sub-systems, such as mission computers, communication systems, navigation systems, displays and external stores, such as pods and smart weapons.

System integration is mainly done during the system development phase of the projects. Moreover, it is a multi-disciplinary process requiring the efforts of the engineering and user communities.

### 4.2.2 Operational Flight Program Integration

Aircraft avionics systems are wholly dependent on operational software. As the software programs become more complex, the testing and certification processes that ensure the viability of those systems must be equal to the task. Software is defined as the information content of a digital computer memory, consisting of sequences of instructions and data for the digital computer.

Software development is separate, but closely related to the systems development. Once the systems functions are allocated to hardware and to software, the separate software implementation process begins. Finally, the hardware and software are brought together for systems integration testing and acceptance.

Every software development proceeds through a sequence of life-cycle phases. Software requirements refinement begins in formulation and extends to late in the implementation phase for the final builds. It should be noted that software requirements may be impacted by any changes in systems requirements. The preliminary systems requirements specifications are updated during this phase, and the ICDs are drafted.

Figure 4-5 illustrates the software functional requirements flow process. Software design begins after the software requirements review and concludes with a software design baseline at the Software Critical Design Review (SWCDR). A Software Preliminary Design Review (SWPDR) is an intermediate milestone during

this phase. The results of the detailed design include the software detailed design specification, and the software test specification and procedure. These documents are base lined at the SWCDR.

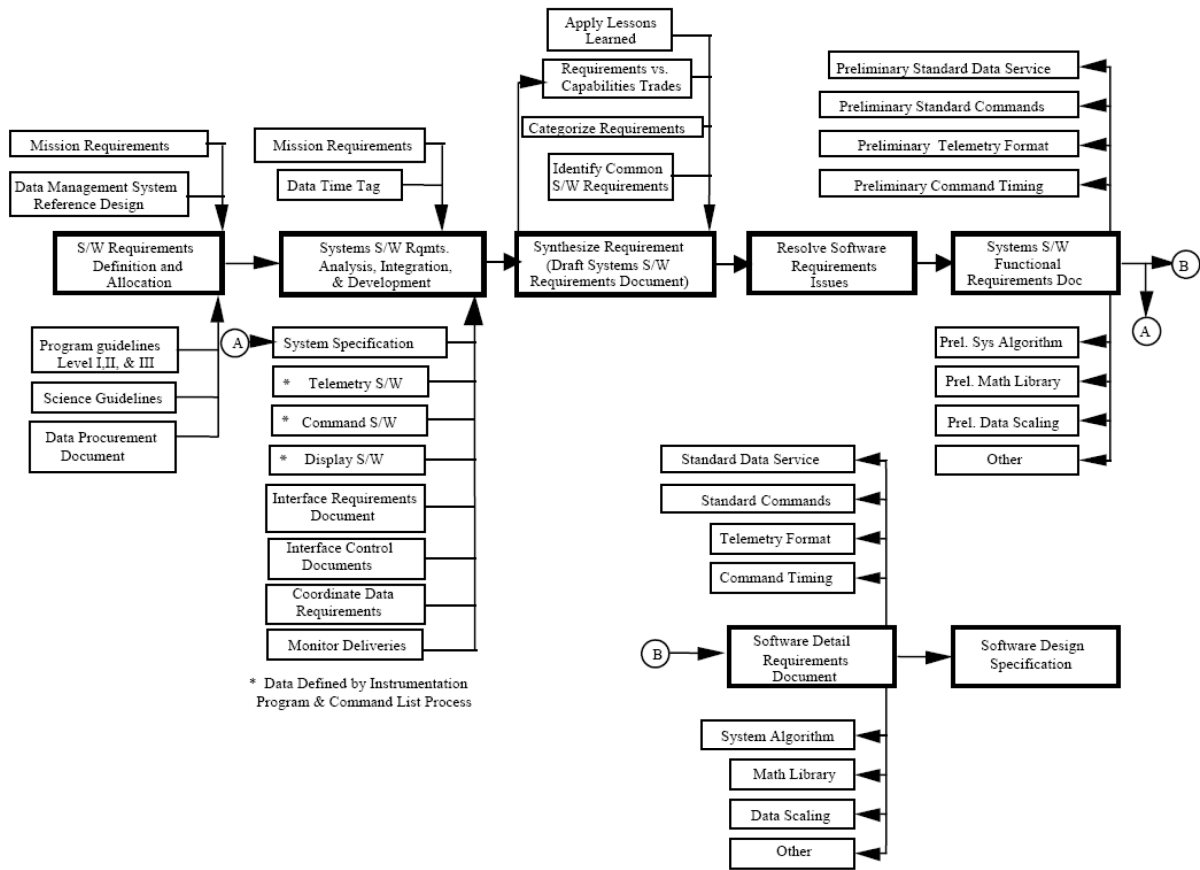

Figure 4-5: Systems Software Functional Requirements Process Flow.

The software is developed through coding and testing after the SWCDR. This level of testing is commonly referred to as “debugging.” At the conclusion of coding and debugging, a test review may be scheduled to assure conformance to test requirements and plans in the subsequent verification, validation, and systems integration tests. Software verification is conducted on the debugged software by a group independent from the “coders and debuggers.” The software is checked against the Software Requirements Specification in a facility, which simulates a closed loop system using as much system or prototype hardware as feasible.

Software validation is a level beyond software verification in that more hardware is used in the testing. Emphasis is on system/software compatibility and sub-system performance. Validation is system integration testing with emphasis on assuring software performance within the system environment. In many projects, software validation is performed on the final product hardware (flight and ground) to ensure system compatibility. If validation is performed on an intermediate set, an additional validation is required for the final hardware product.

System-level testing provides a final test of the software at the highest possible level of testing. The final software delivery and configuration inspection conclude this phase. Software operations and maintenance runs for the life of the project and demands that the configuration control process be maintained. At the end of the project, the final software configuration and documentation become a permanent record in case a project is re-activated or the software is used in future projects [37].



#### 4.2.2.1 The Software Requirements Analysis

While the system design activity will determine the allocation of the new avionic system requirements to various sub-systems, the software requirements analysis activity will complete the analysis of the sub-system requirements to establish sub-system software and interface requirements and descriptions.

This process is also known as feasibility study. In this phase, the development team visits the customer and studies their system. They investigate the need for possible software automation in the given system. By the end of the feasibility study, the team furnishes a document that holds the different specific recommendations for the candidate system. It also includes the personnel assignments, costs, project schedule and milestones. The requirement gathering process is intensified and focused specially on software. To understand the nature of the program(s) to be built, the information domain for the software must be understood, as well as required function, behavior, performance and interfacing. The essential purpose of this phase is to find the need and to define the problem that needs to be solved.

During a software development process, the software's overall structure and logical system of the product is defined primarily. In terms of the client/server technology, the number of tiers needed for the package architecture, the database design, the data structure design shall be defined during this study. A software development model shall be created including analysis and design of the software which is very crucial in the whole development cycle. Any glitch in the design phase could be very expensive to solve in the later stage of the software development. Due to its importance, a software specification/requirements engineering study shall be accomplished. Software specification or requirements engineering is the process of understanding and defining what services are required from the system and identifying the constraints on the system's operation and development. The processes give in Figure 4-6 aims to produce an agreed requirements document that specifies system satisfying stakeholder requirements. Requirements are usually presented at two levels of detail. End-users and customers need high-level statements while the system developers need a more detailed system specification.

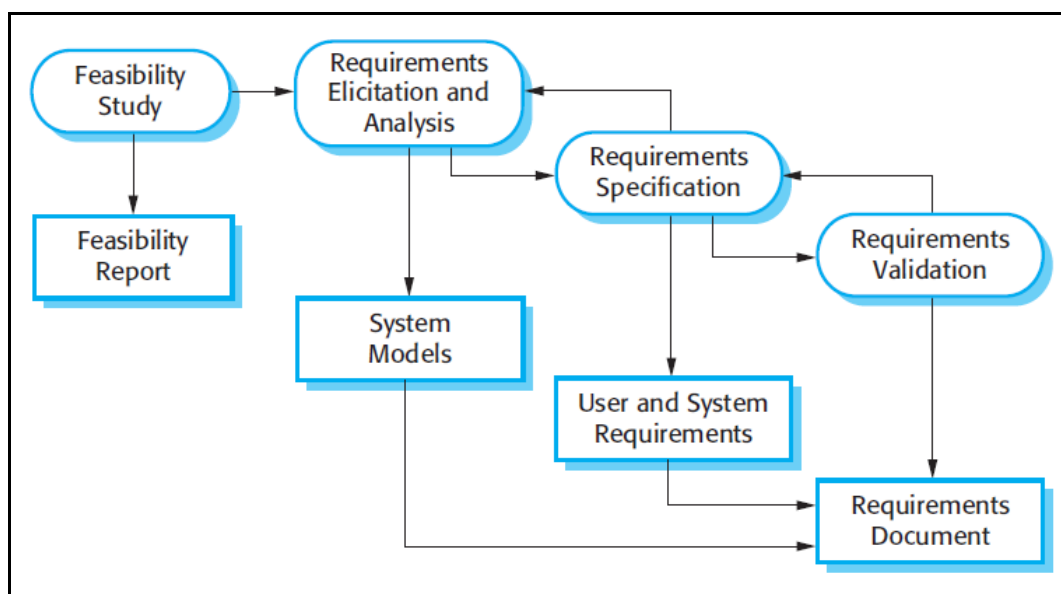

Figure 4-6: The Requirements Engineering Process.

Requirement activities can be divided into four major groups. These are:

- **Feasibility Study:** The study considers whether the proposed system will be cost-effective from a business point of view and if it can be developed within existing budgetary constraints. A feasibility



study should be relatively cheap and quick. The result should inform the decision of whether or not to go ahead with a more detailed analysis.

- **Requirements Elicitation and Analysis:** This is the process of deriving the system requirements through observation of existing systems, discussions with potential users and procurers, task analysis. This may involve the development of one or more system models and prototypes to help understanding of the system to be specified.
- **Requirements Specification:** A document that defines a set of requirements is prepared according to the information gathered during the analysis activity. Two types of requirements may be included in this document. User requirements are abstract statements of the system requirements for the customer and end-user of the system, while the system requirements are a more detailed description of the functionality to be provided.
- **Requirements Validation:** The requirements are checked for realism, consistency, and completeness. During this process, errors in the requirements document are inevitably discovered. It must then be modified to correct these problems.

Of course, the activities in the requirements process are not simply carried out in a strict sequence. Requirements analysis continues during definition and specification and new requirements come to light throughout the process. Therefore, the activities of analysis, definition, and specification are interleaved. In agile methods, such as extreme programming, requirements are developed incrementally according to user priorities and the elicitation of requirements comes from users who are part of the development team.

#### 4.2.2.2 Software Design Phase

Software shall be designed that meets the new functional and performance requirements during this phase. This design shall determine the changes to the overall Operation Flight Program structure and component functional interrelationships. Moreover, it shall reflect new requirement traceability from the software specification down to the Computer Software Units (CSUs). Software Test Plans (STP) shall be written outlining the tests to be conducted to demonstrate compliance with new requirements. Test descriptions shall be developed defining the new test cases. The implementation stage of software development is the process of converting a system specification into an executable system. It always involves processes of software design and programming but, if an incremental approach to development is used, may also involve refinement of the software specification.

A software design is a description of the structure of the software to be implemented, the data models and structures used by the system, the interfaces between system components and sometimes, the algorithms used. This is an iterative process during which the designers converge to the final design at the end. They add formality and detail as they develop their design with constant backtracking to correct earlier designs.

Figure 4-7 is an abstract model of this process showing the inputs to the design process, process activities, and the documents produced as outputs from this process. The diagram suggests that the stages of the design process are sequential. In fact, design process activities are interleaved. Feedback from one stage to another and consequent design rework is inevitable in all design processes.

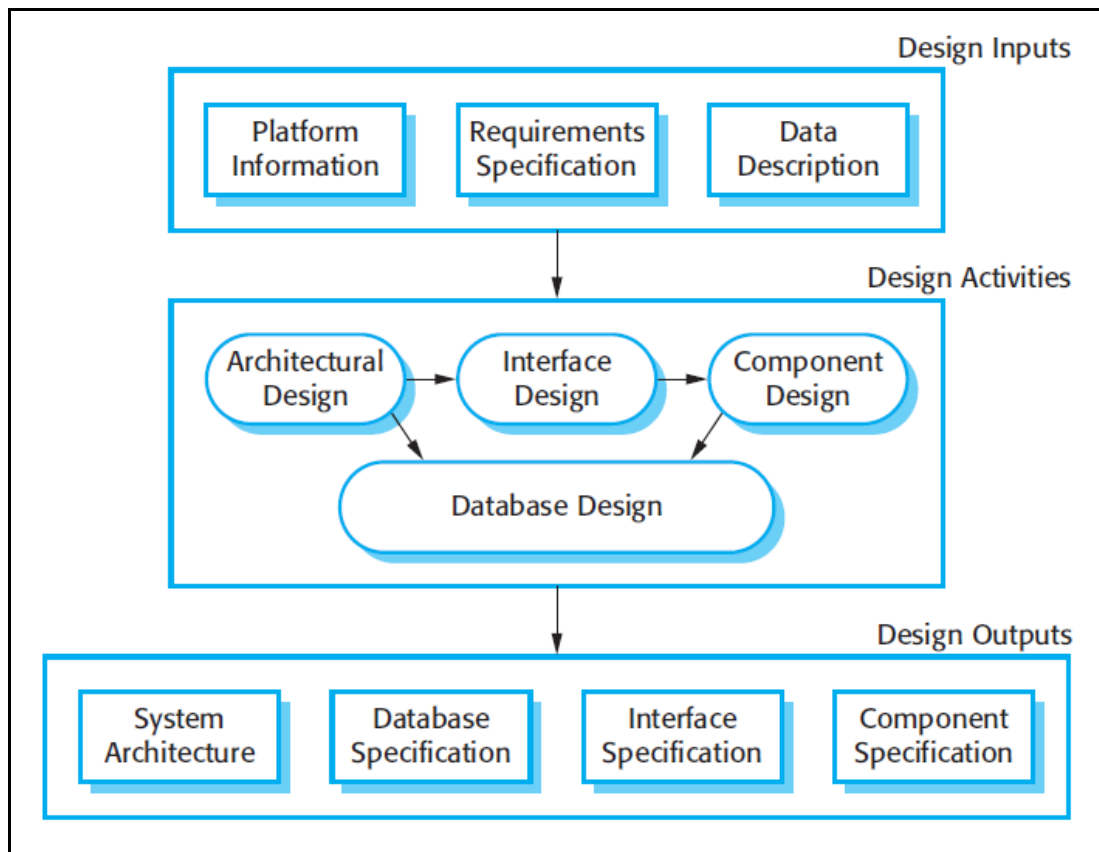

Figure 4-7: A General Model of the Design Process.

Most of the software has interfaces with other software systems. These include the operating system, database, middleware, and other application systems. These make up the ‘software platform’, the environment in which the software will execute. Information about this platform is an essential input to the design process, as designers must decide how best to integrate it with the software’s environment. The requirements specification is a description of the functionality the software must provide and its performance and dependability requirements. If the system is to process existing data, then the description of that data may be included in the platform specification; otherwise, the data description must be an input to the design process so that the system data organization to be defined.

The activities in the design process vary, depending on the type of system being developed. For example, real-time systems require timing design but may not include a database so there is no database design involved. Figure 4-7 shows four activities that may be part of the design process for information systems as explained below:

- **Architectural Design** – where you identify the overall structure of the system, the principal components (sometimes called sub-systems or modules), their relationships, and how they are distributed.
- **Interface Design** – where you define the interfaces between system components. This interface specification must be unambiguous. With a precise interface, a component can be used without other components having to know how it is implemented. Once interface specifications are agreed, the components can be designed and developed concurrently.
- **Component Design** – where you take each system component and design how it will operate. This may be a simple statement of the expected functionality to be implemented, with the specific

design left to the programmer. Alternatively, it may be a list of changes to be made to a reusable component or a detailed design model. The design model may be used to automatically generate an implementation.

- **Database Design** – where you design the system data structures and how these are to be represented in a database. Again, the work here depends on whether an existing database is to be reused or a new database is to be created.

These activities lead to a set of design outputs, which are also shown in Figure 4-7. The detail and representation of these vary considerably. For critical systems, detailed design documents setting out precise and accurate descriptions of the system must be produced. If a model-driven approach is used, these outputs may mostly be diagrams. Where agile methods of development are used, the outputs of the design process may not be separate specification documents but may be represented in the code of the program.

The development of a program to implement the system follows naturally from the system design processes. Although some classes of program, such as safety-critical systems, are usually designed in detail before any implementation begins, it is more common for the later stages of design and program development to be interleaved. Software development tools may be used to generate a skeleton program from a design. This includes code to define and implement interfaces, and, in many cases, the developer need only add details of the operation of each program component.

Programming is a personal activity and there is no general process that is usually followed. Some programmers start with components which are understood well, and after developing these parts, move on to less-understood components. Others take the opposite approach, leaving familiar components till last because they know how to develop them. Some developers like to define data early in the process then use this to drive the program development; others leave data unspecified for as long as possible.

Normally, programmers carry out some testing of the code they have developed. This often reveals program defects that must be removed from the program. This is called debugging. Defect testing and debugging are different processes. Testing establishes the existence of defects. Debugging is concerned with locating and correcting these defects.

When you are debugging, you have to generate hypotheses about the observable behavior of the program then test these hypotheses in the hope of finding the fault that caused the output anomaly. Testing the hypotheses may involve tracing the program code manually. It may require new test cases to localize the problem. Interactive debugging tools, which show the intermediate values of program variables and a trace of the statements executed, may be used to support the debugging process.

#### **4.2.2.3 Coding**

The Coding phase will include developing test procedures for conducting Computer Software Component (CSC) and CSU tests and coding the CSUs. Informal code verifications will be performed to ensure the proper design implementation. Reviews of informal development test results and procedure checkouts will be performed to ensure the product integrity. These tasks will be accomplished by two activities:

- CSU testing; and
- CSC integration and testing.

The design must be translated into a machine-readable form. The code generation step performs this task. If the design is performed in a detailed manner, code generation can be accomplished without much complication. Programming tools like compilers, interpreters, debuggers are used to generate the code. Different high-level programming languages are used for coding according to application type which fulfills the requirements.

#### 4.2.2.4 Software Testing

Testing is intended to show that a program does what it is intended to do and to discover program defects before it is put into use. When you test software, you execute a program using artificial data. You check the results of the test run for errors, anomalies, or information about the program's non-functional attributes.

Testing of software for avionics systems has two complementary objectives. One objective is to demonstrate that the software meets its requirements. For custom software, this means that there should be at least one test for every requirement in the requirements document. For generic software products, it means that there should be tests for all of the system features, plus combinations of these features, that will be incorporated in the product release. The second objective is to demonstrate with a high degree of confidence that errors, which could lead to unacceptable failure conditions, as determined by the system safety assessment process, have been removed. It is used to discover situations in which the behavior of the software is incorrect, undesirable, or does not conform to its specification. These are a consequence of software defects. Defect testing is concerned with rooting out undesirable system behavior such as system crashes, unwanted interactions with other systems, incorrect computations, and data corruption.

The first goal leads to validation testing, where you expect the system to perform correctly using a given set of test cases that reflect the system's expected use. The second goal leads to defect testing, where the test cases are designed to expose defects. The test cases in defect testing can be deliberately obscure and need not reflect how the system is normally used. Of course, there is no definite boundary between these two approaches to testing. During validation testing, defects can be found in the system. These defects are fixed during defect testing and some of the tests will show that the program meets its requirements as defined by validation testing.

The diagram shown in Figure 4-8 may help to explain the differences between validation testing and defect testing. The system accepts inputs from some input set and generates outputs in an output set. Some of the outputs will be erroneous. These are the outputs that are generated by the system in response to given inputs. The priority in defect testing is to find those inputs which results in problems in the system.

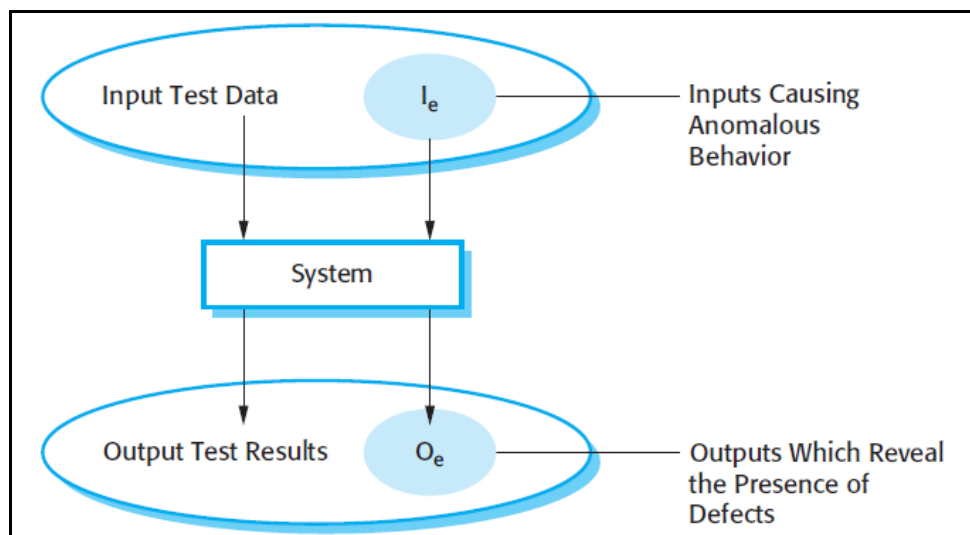

Figure 4-8: An Input-Output Model of Program Testing [38].

These stimulate the system to generate the expected correct outputs. Testing cannot demonstrate that the software is free of defects or that it will behave as specified in every circumstance. It is always possible that a test that you have overlooked could discover further problems with the system. Testing can only show the presence of errors, not their absence.

Requirements-based testing is emphasized because this strategy has been found to be the most effective at revealing errors. Therefore, to satisfy the airborne software, testing of objectives is executed in accordance with the DO-178B [39] standard. This includes but not limited to:

- Test cases should be based primarily on the software requirements;
- Test cases should be developed to verify correct functionality and to establish conditions that reveal potential errors;
- Software requirements coverage analysis should determine what software requirements were not tested; and
- Structural coverage analysis should determine what software structures were not exercised during testing.

Once the code is generated, the software program testing begins. Different testing methodologies are available to unravel the bugs that were committed during the previous phases. Different testing tools and methodologies are already available. Some companies build their own testing tools that are tailor made for their own development operations.

The development testing and procedure development phase will ensure the software product meets the allocated requirements. A draft Software Test Plan will be produced during this phase.

#### **4.2.2.5 Software Maintenance**

Software will definitely undergo change once it is delivered to the customer. There can be many reasons for this change to occur. Change could happen because of some unexpected input values into the system. In addition, the changes in the system could directly affect the software operations. The software should be developed to accommodate changes that could happen during the post-implementation period.

The transition to customer phase will complete the software maintenance process. In this phase the OFPs and documentation will be delivered to the customer in accordance with the contract. A project completion report will be produced.

#### **4.2.2.6 Operational Flight Software Development Overview**

The operational flight software is the application software resident in the aircraft mission computers performing the avionic functions required in order to fulfill the mission requirements. An example of operating flight software architecture and operational flight software development process is given in Figure 4-9.

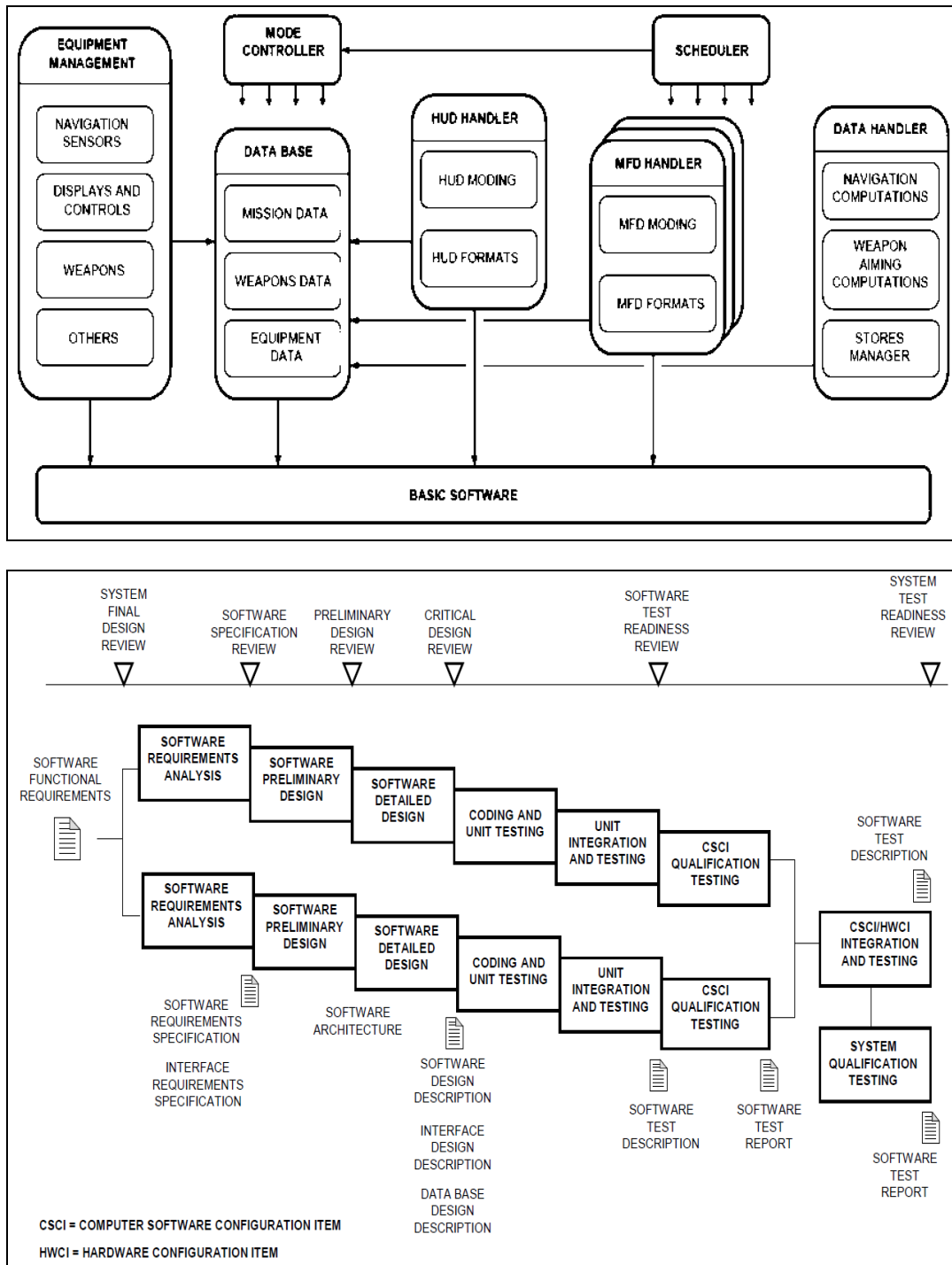

Figure 4-9: Operational Flight Software Development Process [40].

The operational flight software development process composed of two life-cycle activities. First one is the primary life-cycle activities which consist of all the acquisition, supply, development, operation and maintenance activities. The operational flight software development process shown in Figure 4-9 depicts the development part of the life-cycle activity. Second one is the supporting life-cycle activities that are documentation, configuration management, quality assurance, verification, validation, audit and problem resolution. The supporting life-cycle activities must be performed carefully to achieve qualified OFP.

#### 4.2.2.7 Configuration Management

Software configuration management process used to identify the initial products and to be able to maintain the integrity of these products throughout the project's software life cycle until the final submittal/completion.

There are two types of Software Configuration Management (SCM) activities, which can be categorized as formal SCM activities and developmental SCM activities. First group of activities include; planning of aircraft part installations, authorization of changes to the aircraft configurations, releasing aircraft configurations to the field, and tracking aircraft configurations in the field. On the other hand, developmental SCM activities includes, planning and controlling the changes to all software products, tracking status changes to the software products until completion, releasing the software products to independent testing and to the customer.

#### 4.2.2.8 Systems Integration Laboratory Tests

System Integration Laboratory facilities allow testing electrical and logical interfaces of both platform and store/LRU in a safe and controlled environment. OFP's that are recently developed and completed their unit tests can be deployed on instrumented hardware in these facilities for interoperability testing. An example of such laboratory is given in Figure 4-10.



**Figure 4-10: A System Integration Laboratory.**

A SIL facility may have extensive test features and capabilities depending on the capabilities provided by platform manufacturer. The facility may be programmed to provide a static configuration, in which it is comparable to an actual aircraft on the ground, and utilizing real hardware components (air data computer, altimeters, inertial navigation systems, etc.) in the loop. A dynamic configuration can also be provided which simulates the aircraft in the flight. In the dynamic configuration, real-time simulation models for dynamic devices and sensors are used to simulate aircraft dynamic flight conditions. Data monitoring, recording, data retrieval capabilities for avionics systems are vital for a SIL facility. Real-time data display and data patching/manipulation capabilities should also be present in SIL facilities as shown in Figure 4-11.



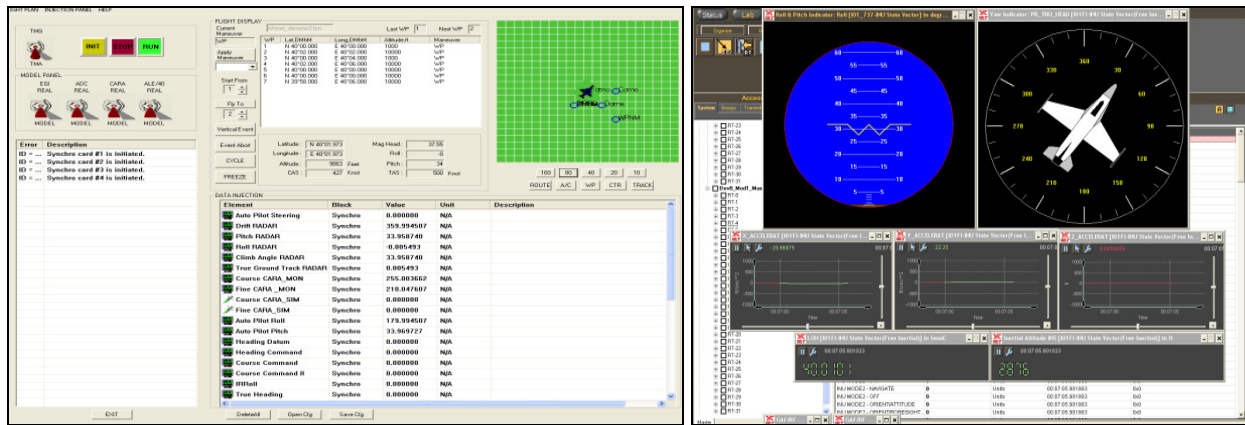

Figure 4-11: A Typical Data Monitoring and Real-Time Data Display Capability.

SIL-testable equipment generally have the exact hardware and software of the main store computer, with an additional interface connection to PC for data modification, error injection and monitoring. Components of the store that are electrically active during captive carry phase should be on the test equipment or have their data generated and delivered by PC. Hazardous components such as fuzes, squibs, live munitions, fuel tanks, warheads must be removed and replaced with functional equivalent components.

In case of the absence of a SIL-testable equipment with real hardware, an emulator which has the same data interface (MIL-STD-1553 [12], RS-232, etc.) functionality may also be employed to do the SIL testing so that the OFP be developed and tested in parallel with the development of the external store or the LRU.

SIL tests mainly involve testing of data interface of platform and store by monitoring the contents and timings of the messages and discrete signals. The fault injection capabilities on both sides allow detailed coverage of the code and reduce in-flight test error probabilities.

As an example the functionalities that can be tested thoroughly in SIL environment for air-to-ground munitions involves but not limited to:

- Power appliance and removal;
- Built-in test mechanisms;
- Transfer alignment;
- Time stamping of messages;
- Mode commands;
- Broadcast messages;
- Targeting;
- Telemetry and/or data-link activation;
- Programmable fuze interactions;
- Mass data transfers;
- Launch acceptability region;
- Dynamic launch zone;
- Opportunity target modifications;
- Box drop testing;

- HUD symbology;
- Seeker/sensor control;
- Store engine operations;
- Geozone control;
- GPS data loading; and
- Jettison and critical data erase operations.

### 4.3 MISSION PLANNING SYSTEM INTEGRATION

Mission planning software is responsible from building the mission plan data for a specific target considering the store flight and impact characteristics and then loading and placing it on the Data Transfer Cartridge (DTC). DTC formatting is platform-specific and it is determined within the platform Unique Planning Component (UPC). Mission data formatting is store specific and determined within the store UPC. A simple Interface schema of the Mission Planning System is shown in Figure 4-12.

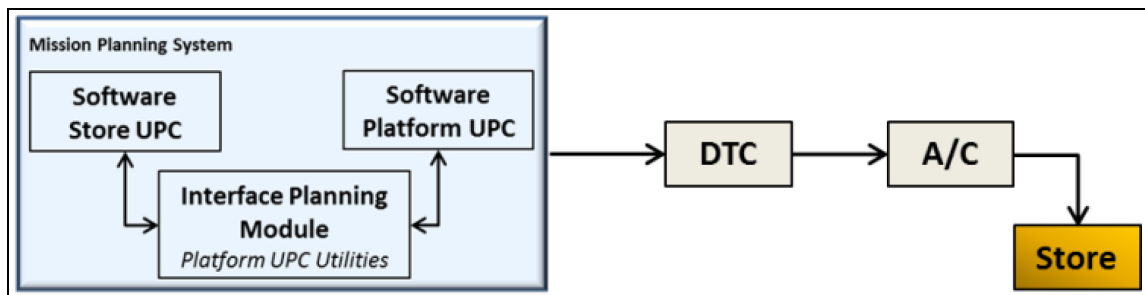

Figure 4-12: Mission Planning System Interfaces.

### 4.4 AERO-MECHANICAL AND STRUCTURAL INTEGRATION

#### 4.4.1 Analysis

##### 4.4.1.1 Physical Fit and Mechanical Interface Analysis

Physical shape and mechanical interfaces of stores should be designed according to the limitations and requirements of the carrying platforms. Hence, the limits of the physical parameters such as length, width, wing span, chord and diameter of the store should be determined during the preliminary design stages of the development projects. For this purpose 3D models of aircraft that have the capability of simulating the moving parts should be prepared and limits of the design space should be determined by using this model. This model may also be used to determine mechanical interface requirements and limitations.

##### 4.4.1.2 Aerodynamic Analysis

Platform/store compatibility studies cannot be realized with the lack of computational analyses in a budget optimized development project. According to computational analysis results, critical flight and release conditions can be determined and wind tunnel test program can be shortened. In this way, the wind tunnel testing is used only for accurate predictions of flight clearances which are considered as critical according to analysis results. With the coupling of these two methods flight test matrix can be minimized too. Detail of this approach has been described in references [41] and [42].

Starting with the 1960's, some of the Computational Fluid Dynamic (CFD) codes were started to provide trajectory solutions for the stores in the effect of carrier platform flow field. However, at that time, since the computational power was not sufficient for such large problems, techniques were limited to some linear theories and panel methods. With the advancements in the computational power, the capabilities and accuracy of the codes were also advancing. Higher order panel methods, Euler solvers and finally fully unsteady Navier-Stokes solvers were developed and applied to separation problems with the advancements in the computation power. Today, a separation problem may be solved with a fully unsteady N-S solver in couple of hours with the help of high-performance parallel computing facilities.

Nowadays, drag index, aerodynamic flight loads and its effect on aircraft performance and separation characteristics of stores can be analyzed by computational fluid dynamics analysis tools.

#### 4.4.1.2.1 Flight Loads, Carriage Envelope and Performance Analysis

Aerodynamic loads on a store during carriage stage differ from free flight loads. Moreover, these loads may result in a performance defect in carrying platform. Hence, change in the aerodynamic characteristics of store should be analyzed and effect of aerodynamic loads on the platform performance should be analyzed for the carriage envelope. At the end of these analyses, carriage envelope of platform for the analyzed specific loading conditions should be clearly defined. Figure 4-13 shows an example to flight envelope.

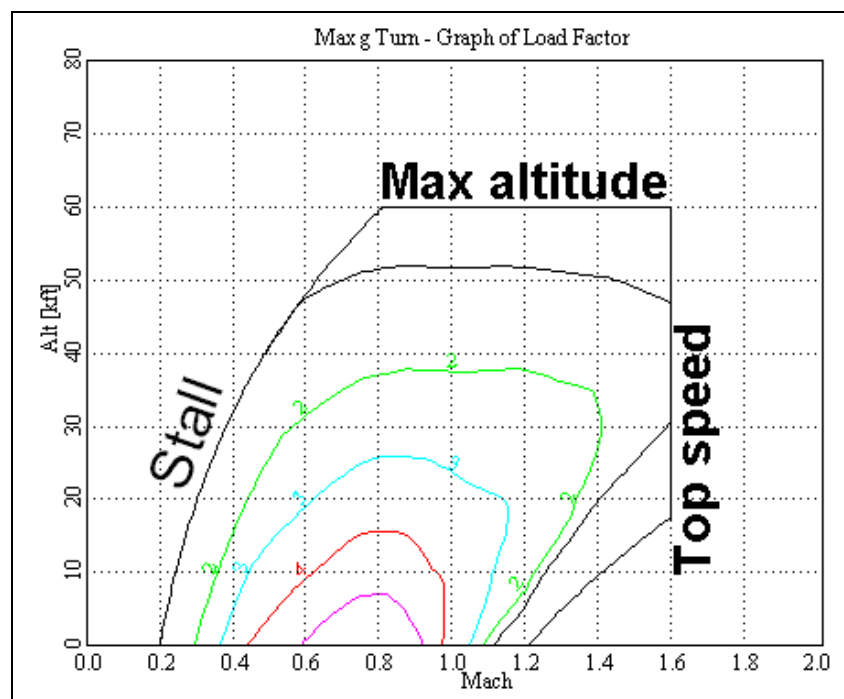

Figure 4-13: An Example to Flight Envelope.

#### 4.4.1.2.2 Drag Index

Drag index is one of the measures of store effect on fuel consumption for the given loading configuration of carrying platform. Increase in the total drag of the carrying platform with a new integration shall be calculated and non-dimensionalized for the most flown conditions for accurate mission planning. Calculation methodology of drag index value of a store for different platforms may vary according to platform cruise Mach number, angle of attack and other platform related physical reference values. Hence, one store may have different drag index value at different platforms.

#### 4.4.1.2.3 Separation Analysis

An envelope for both operational and jettison releases should be predicted accurately to determine safe separation region and to support and decrease wind tunnel tests. A computational fluid dynamics solver, 6-DOF solver and mesh movement technique is combined to model separation phenomena. Separation analysis examples are shown in Figure 4-14.

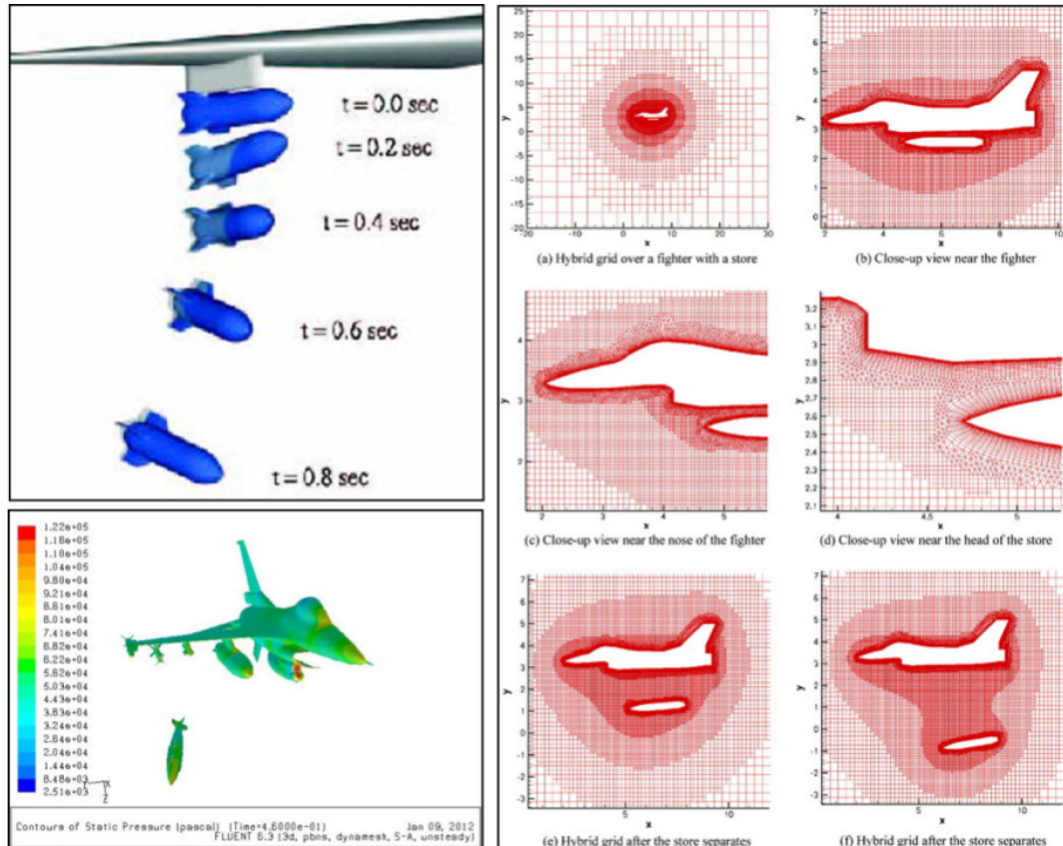

Figure 4-14: Separation Analyses Examples.

There are several methods used for mesh movement during the analysis. Most used examples are Chimera Method and Spring Analogy with re-meshing.

In the chimera method, domain is modeled with separate zones, which interconnects the solutions at the mesh interface areas. On the other hand, for the second method, mesh is deformed by spring analogy and quality is increased by re-meshing during the trajectory simulation.

A store separated from the aircraft defines a rigid body with Six Degrees Of Freedom (6-DOF). Therefore, it is possible to determine the track of the store by solving the rigid body motion in time by 6-DOF rigid body motion solver, provided that forces and moments acting on the body is known at any point in the solution domain. Motion of the store can be considered in two distinct phases. First is the motion under the ejector forces and second is the free motion where store is moving with aerodynamic forces. It is often assumed that ejector forces are high enough that the variation of the aerodynamic forces can be neglected. The motion in the first phase, between the moment of release and until the End-Of-Stroke (EOS) position can be simulated with a 6-DOF solver considering only free-stream aerodynamic forces and moments and ejector forces, or with a simple use of charts provided by ejector/aircraft manufacturer. In this approach, free motion of the store is started using EOS linear and angular speeds as initial conditions. Then 6-DOF

simulation is performed by using aerodynamic and gravity forces and proximity of the store and the aircraft is checked until the time where proximity is critical or safe. By use of these methods, the limits of safe separation envelope should be determined.

### 4.4.1.3 Environmental Analysis

#### 4.4.1.3.1 Thermal Analysis

Prediction and analysis of thermal loads play an important role to control/analyze the compatibility and integration of an aircraft and weapon. Thermal conditions need to be considered at the beginning of the project and all temperature sensitive items shall be selected compatible with the temperature data. Thermal analysis example and temperature change during flight are shown in Figure 4-15 and Figure 4-16. Thermal loading analysis for the compatibility, integration and separation testing can be analyzed in two main sub-sections which are stages and temperature effects.

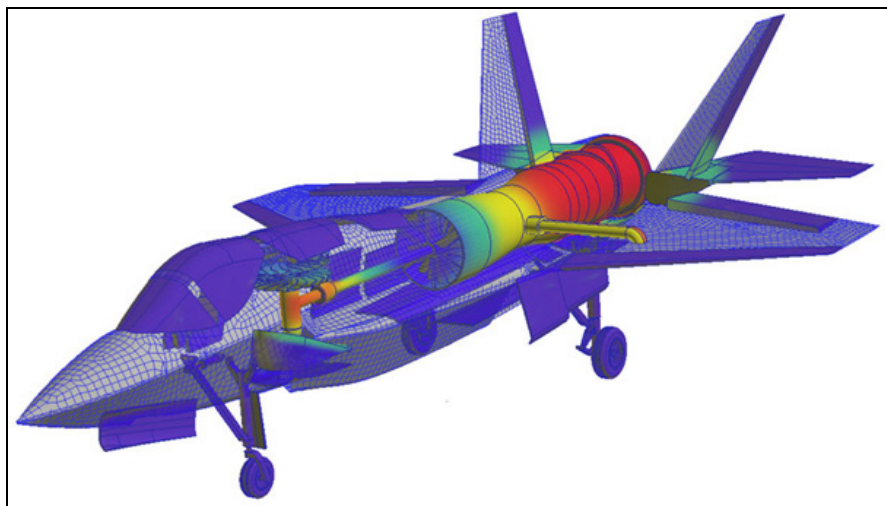

Figure 4-15: Thermal Analysis of an Aircraft.

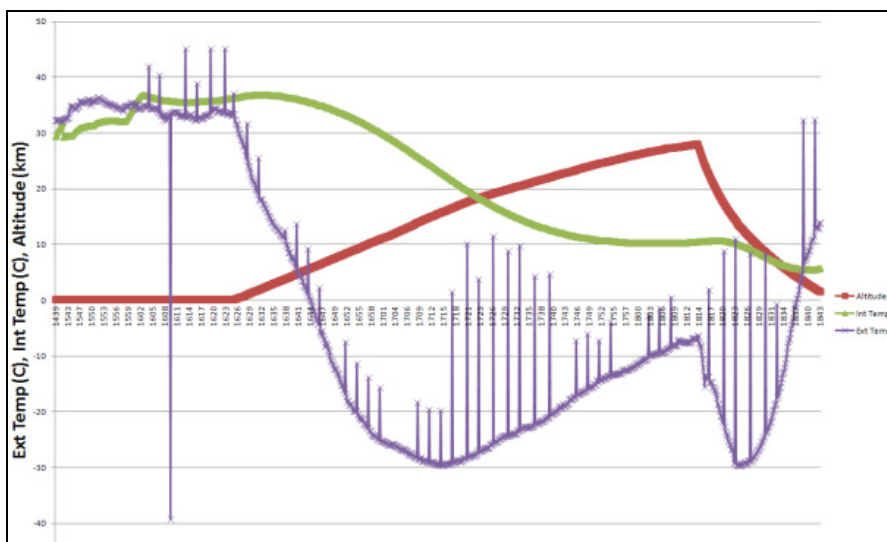

Figure 4-16: An Example to Temperature Changes for a Flight Profile.



#### 4.4.1.3.1.1 Storage Stage

Thermal loading analysis shall be started considering the storage stage including both storage inside containers and waiting at the runway.

Boundary conditions are selected according to the related military documents (MIL-HDBK-310 [43], NATO STANAG 2895 [44], etc.) and environmental data of the mission area. Storage stage thermal load analysis shall include not only storage inside containers but also waiting at the runway. Solar effects shall also be considered especially at the runway.

#### 4.4.1.3.1.2 Captive Carry Stage

Once the weapon is loaded onto the aircraft and aircraft takes-off, air temperature effects and aerodynamic heating start to play a very important role.

It is clearly known that air temperature decreases when the flight altitude is increased. However, temperature on the surface of the weapon/aircraft increases when the flight Mach number is increased. Captive carry analysis shall be performed after the detailed analysis of the flight envelope and all corners of the flight envelope (Figure 4-17) need to be considered.

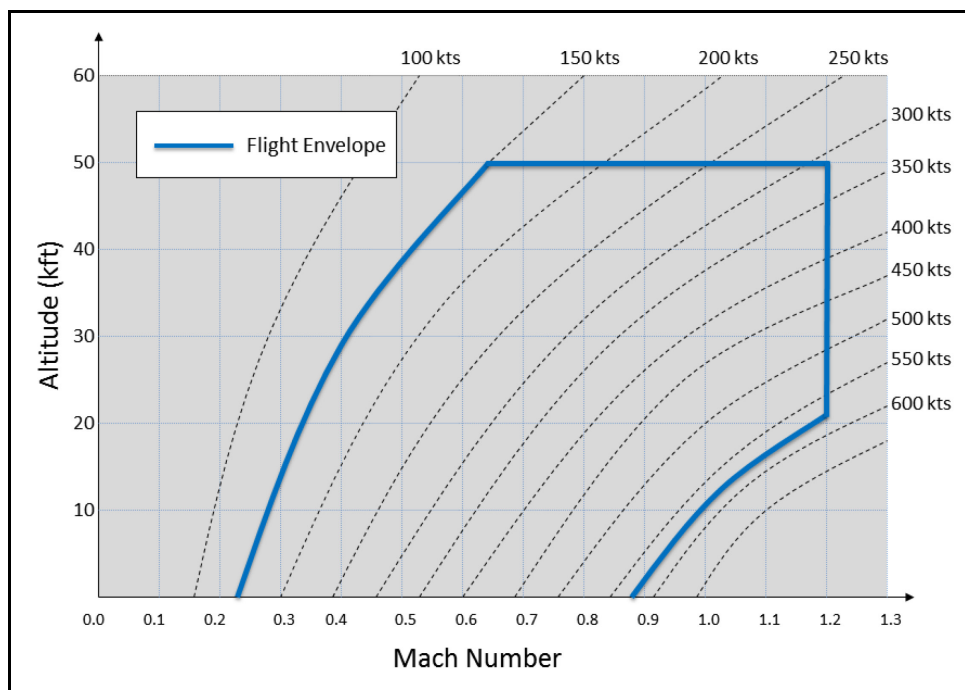

Figure 4-17: An Example to Flight Envelope.

Captive carry stage thermal analysis shall include climbing and/or diving before the separation of the weapon. Aircrafts have minimum and maximum flight speed and altitude limits for the desired loading configuration. Loading configuration not only effects flight speed and altitude but also effects the total duration of the captive carry stage thermal analysis boundary conditions.

#### 4.4.1.3.1.3 Low Temperature Effects

World is divided into several low temperature zones (Figure 4-18) (i.e. five zones according to the NATO STANAG 2895 [44]) and recorded lowest temperature for the subject zones vary compared to each other.

Once the design standards and design zones are selected, both storage and captive carry stages shall be analyzed according to the related temperature data. In addition, since the air temperature decreases when the altitude increases in the Troposphere (up to ~10 km) and reaches ~215 K in Stratosphere (according to the standard atmosphere model), this much low temperature shall be considered at the captive carry stage. Although the surface temperature of the weapon/aircraft increases due to adiabatic heating, low flight speed and high altitude combination decreases the surface temperature of the systems to very low temperature levels.

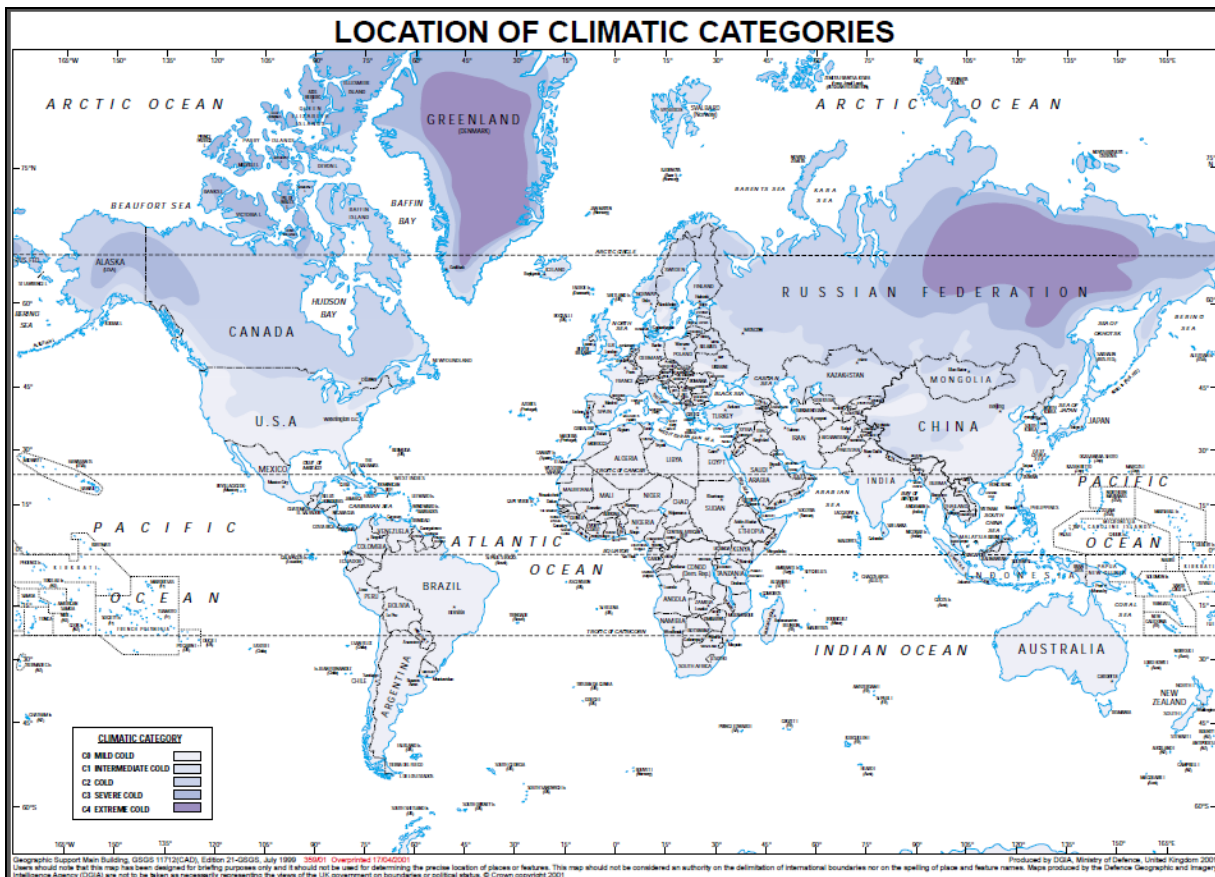

Figure 4-18: Low Temperature Zones.

4.4.1.3.1.4 High Temperature Effects

World is divided into several high temperature zones (Figure 4-19) (i.e. three zones according to the NATO STANAG 2895 [44]) and recorded highest temperature for the subject zones vary compared to each other. Once the design standards and design zones are selected, both storage and captive carry stages shall be analyzed according to the related temperature data. Although the air temperature decreases with the altitude, wall temperature of the weapon/aircraft increases due to adiabatic heating, which is caused by the increasing flight Mach number. High flight speed and low altitude combination increases the surface temperature of the systems to the very high temperature levels.



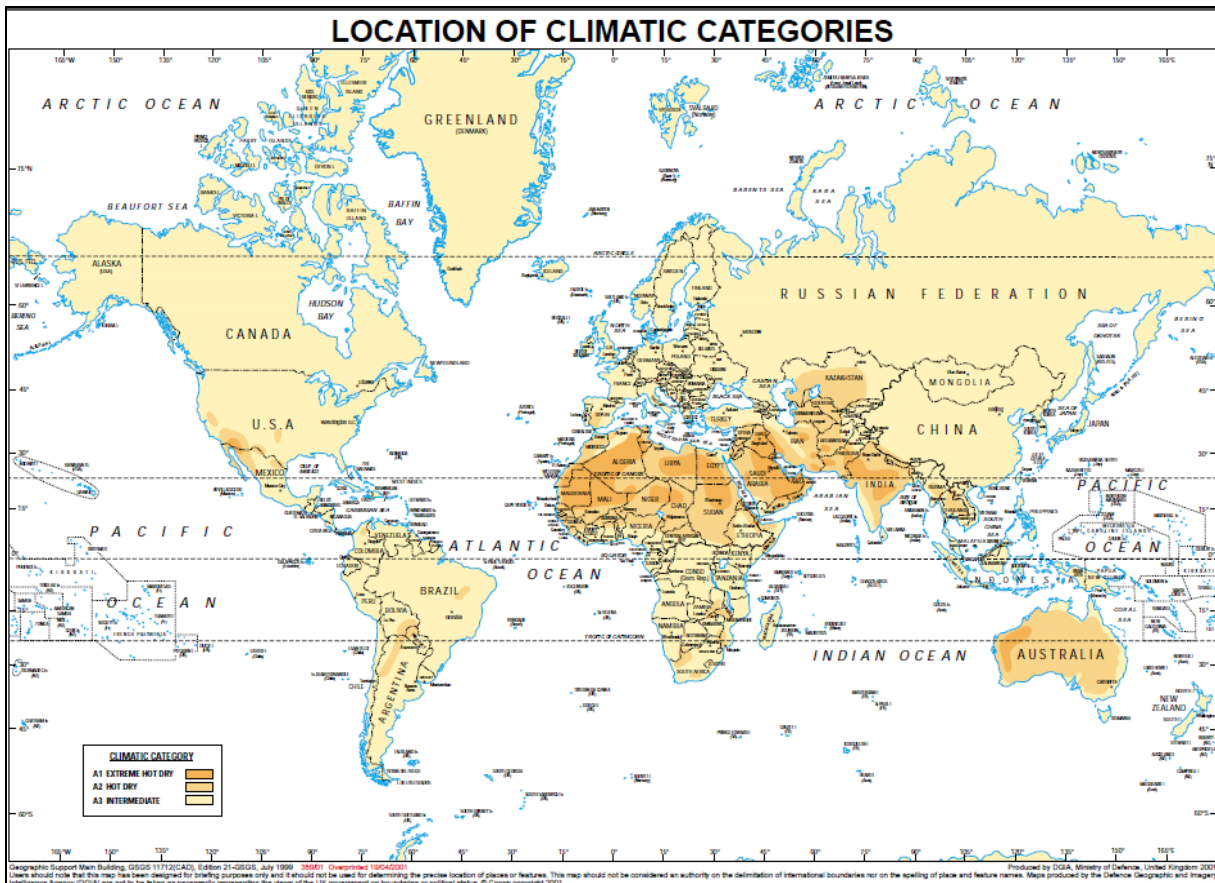

Figure 4-19: High Temperature Zones.

4.4.1.3.1.5 Thermal Shock Effects

Once the flight and operation envelope is selected, aircraft may involve instant maneuvers due to the unexpected and/or planned situations/operation plans. These maneuvers may include instant climbing from low altitude to the high altitude or the opposite (Figure 4-20).

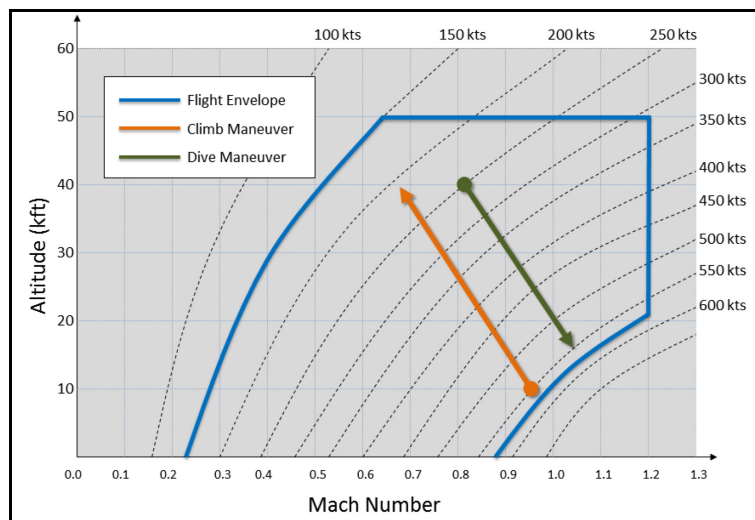

Figure 4-20: Instant Climb and Dive Maneuvers in Flight Envelope.

Since the air temperature and adiabatic wall temperature of the system instantly changes with the subject conditions, external body of the weapon/aircraft and components near the outer sections of the systems expose to thermal shocks.

#### 4.4.1.3.2 Aeroelastic Effects Analysis

Aircraft structures are generally extremely flexible compared to the ground structures. Therefore, they undergo large deformations and distortions under load. When these loads are caused by aerodynamic forces, which themselves depend on the geometry of the structure and the orientation of the various structural components to the surrounding airflow, then structural distortion results in changes in aerodynamic load, leading to further distortion. The interaction of aerodynamic and elastic forces is known as aeroelasticity. Two distinct types of aeroelastic problem occur. One involves the interaction of aerodynamic and elastic forces of the type described above. Such interactions may exhibit divergent tendencies in a too flexible structure, leading to failure, or, in an adequately stiff structure, converge until a condition of stable equilibrium is reached. In this type of problem static or steady state systems of aerodynamic and elastic forces produce such aeroelastic phenomena as divergence and control reversal. The second class of problem involves the inertia of the structure as well as aerodynamic and elastic forces. Dynamic loading systems, of which gusts are of primary importance, induce oscillations of structural components. If the natural or resonant frequency of the component is in the region of the frequency of the applied loads, then the amplitude of the oscillations may diverge and cause a failure. The various aeroelastic problems may be conveniently summarized in the form of a 'tree' as given in Figure 4-21.

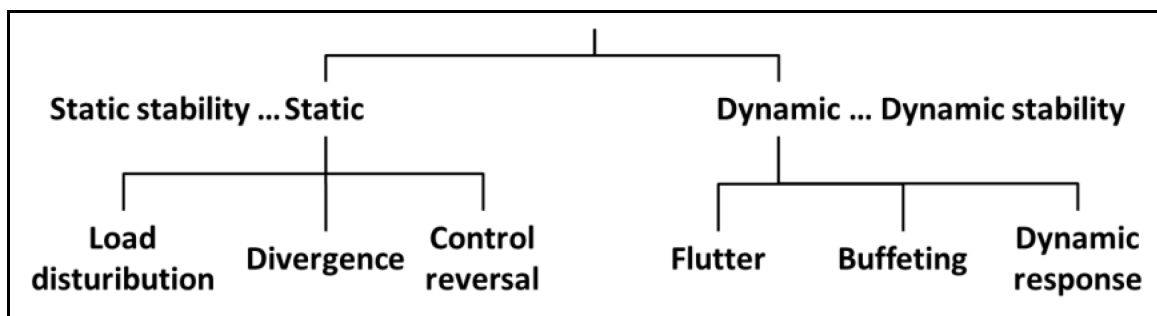

Figure 4-21: Various Aeroelastic Problems [45].

Aeroelastic behavior of a mechanical system is mainly determined by its dynamic properties. Natural frequencies, mode shapes and damping characteristics have important effect on the aeroelastic behavior. Therefore, any additional mass, stiffness or damping could change systems aeroelastic behavior.

For the aircraft and store compatibility, aircraft should not change its aeroelastic behavior within its flight envelope while captive carry of stores. In order to be sure about aeroelastic behavior stability following examinations should be performed:

- Dynamic behavior of the aircraft/stores system should be determined by modal analysis or modal testing;
- Aeroelastic failure modes should be examined within the flight envelope; and
- Aeroelastic aircraft/stores system compatibility should be tested and verified with flight tests.

#### 4.4.1.3.3 Acoustic Analysis

Sound could simply be defined as vibration of air or travelling pressure waves. These vibrations are transmitted to the structures. As an aircraft structure on air is considered, there are lots of noise sources like,

engines, rotors, turbulent flow, etc. These noises, or pressure changes, excite both the stores and the aircraft. Depending on the natural frequencies of the store and/or the aircraft and excitation frequencies of the noise mechanical failures could be generated. Especially, the situation could be more drastic for externally-mounted stores due to highly turbulent flow and structural vibration of aircraft. Therefore, acoustic environment should be taken into account while design and verification phases.

#### 4.4.1.3.4 Vibration Analysis

Basically all of the noise sources cause mechanical vibrations. However, the most affective source of vibration for aircrafts is turbulent flow environments. In-flight vibration exposure example is shown in Figure 4-22. Vibration environment for a store or equipment can be tailored by using the military standards or real-life testing. However, it is not possible to take vibration measurements in preliminary design stage. Therefore, the best practice is to use military standards for preliminary design stage and then verification with real-life testing and measurements. The most commonly used military standard for estimating vibration environment is MIL-STD-810 [36]. If the flight conditions are approximately known, then MIL-STD 810 can be used to estimate the vibration environment [46]. Then, individual store components and store could be verified by finite element analysis and vibration tests on the ground. It is also advised to make vibration tests using flight measurements on the ground.

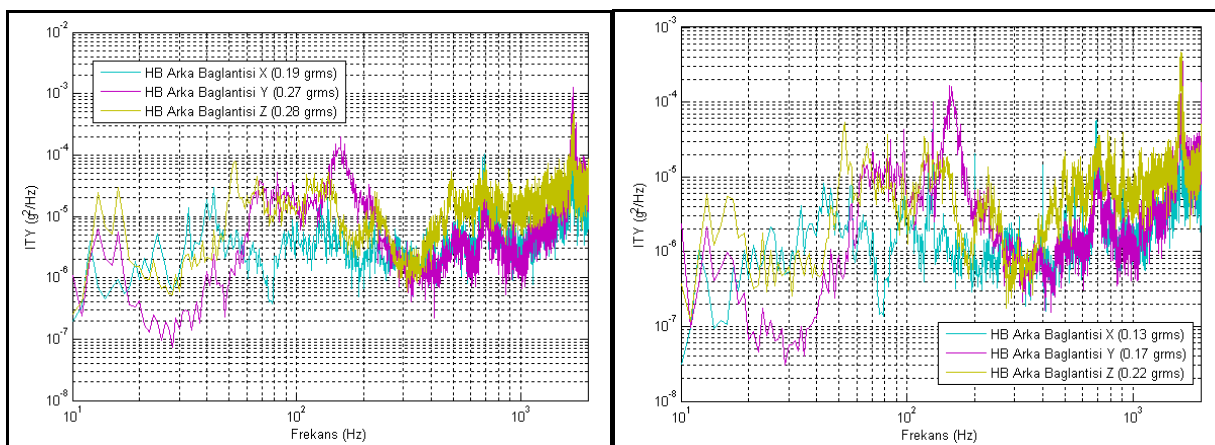

Figure 4-22: An Example to Power Spectral Density Analyses of Flight Acceleration Data.

#### 4.4.1.4 Structural Integration Analysis

##### 4.4.1.4.1 Effects of Release Loads on Store and Platform

Stores are released from the platform by using pyrotechnic ejector racks. The motion of the store during separation is mainly determined by the type of rack used and the ejector rack release configuration. The most commonly used ejector rack is the MAU-12, which is presented in previous sections. It can be used with applications on F-16, F-15A-D, B-52H, AC-130H, AC-130U, F-117, MC-130H Talon II and A-10 platforms.

The MAU-12 ejector rack is 32.0 inches long, 3.0 inches wide, 6.0 inches in height, and weighs about 70 pounds. It has two electrically activated pyrotechnic cartridges and an ejection mechanism that releases and pushes downward the store by means of pyrotechnically generated pressure. Total ejection force is determined by the used cartridges. However, forward and aft ejection force percentages are determined by the diameter of the forward and aft orifices. Performance of the MAU-12 ejector rack with various configurations is examined by Ryan E. Carter [47]. As can be seen from Figure 4-23, forces applied to the store and the platform during ejection can be obtained experimentally.

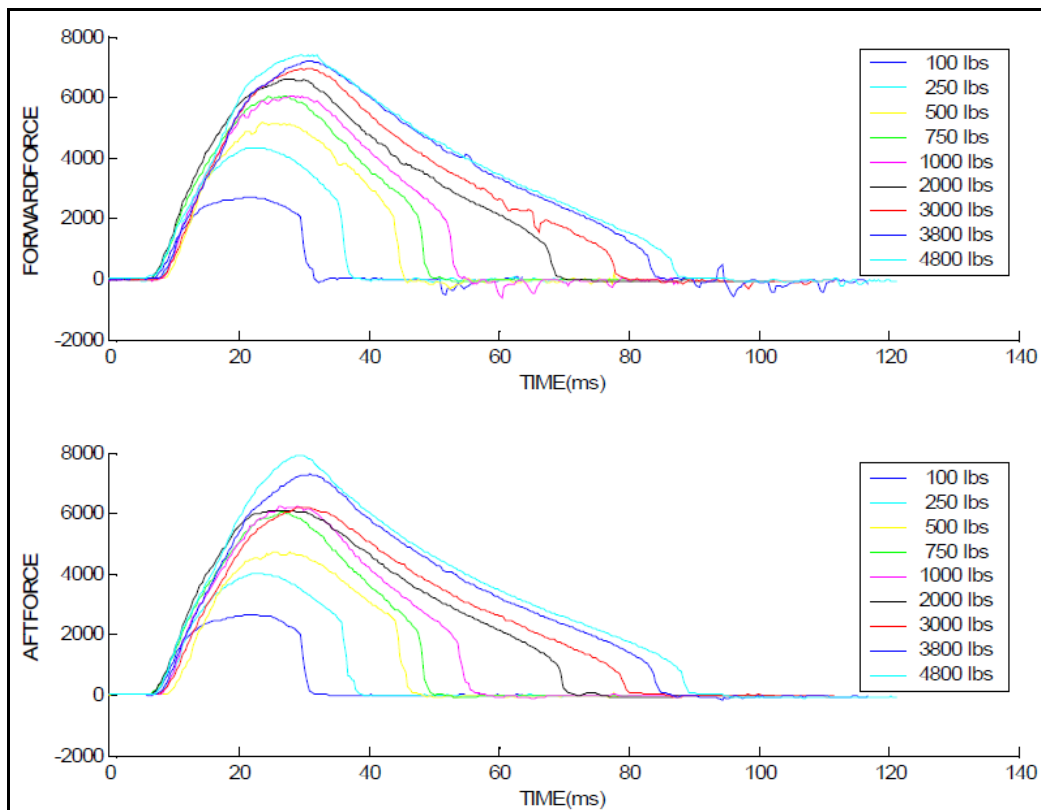

**Figure 4-23: Forward and Aft Ejection Forces vs. Time for Ard-446/Ard-863 Cartridges and -4/-4 Orifice Setting for Store Weights from 100 to 4800 lbs [47].**

Then, it could be said that ejection force for MAU-12 can be determined by:

- Cartridge types;
- Orifice types; and
- Store weight.

For a newly developed store, ejection force for all applicable cartridges and orifice settings should be determined theoretically or experimentally. Then, structural integrity should be satisfied under these transient loading conditions. Due to transient behavior of the ejection force, especially fragile electronic store components should be verified. Due to dynamic behavior of the store components, ejection force input could be dynamically amplified. Structural integrity of the platform should also be examined and verified in detail, if one or more of the following conditions are met:

- Greater store weight than the certified store weights for the platform; and
- Use of uncertified cartridges and orifice settings.

#### 4.4.1.4.2 *Effects of Maneuver Loads on Store and Platform*

General structural and mechanical design criteria for airborne stores, suspension equipment and their associated interfaces are standardized with MIL-STD-8591 “Department of Defense Design Criteria Standard – Airborne Stores, Suspension Equipment and Aircraft/Stores Interface (Carriage Phase)” [48]. This standard provides requirements for design, analysis, and testing of airborne stores, suspension equipment and the aircraft/stores interface during captive operations. Maneuver loads can be classified according to MIL-STD-8591 as given below:

- **Aerodynamic Loads:** The aerodynamic loads to be used for wing or stores shall be developed from store free stream aerodynamic data using the angles of attack and sideslip. Values of dynamic pressure,  $q$ , shall be determined for all critical conditions of velocity to which the store is intended to be subjected. All air loads should be added to the inertial load component. Aerodynamic load distribution can be determined by one or more of the following methods:
  - Classic analytical derivation;
  - Wind tunnel measured pressures;
  - Wind tunnel measured, calibrated control surface loads; and
  - CFD derived distribution, corrected and correlated to wind tunnel and/or flight test data.
- **Inertia Loads:** Inertial loads applied to the store center of gravity can be determined by using the load factor envelope of the platform. Load factor envelope can be determined by using MIL-STD-8591 [48]. General view of load factor envelope is given in Figure 4-24.

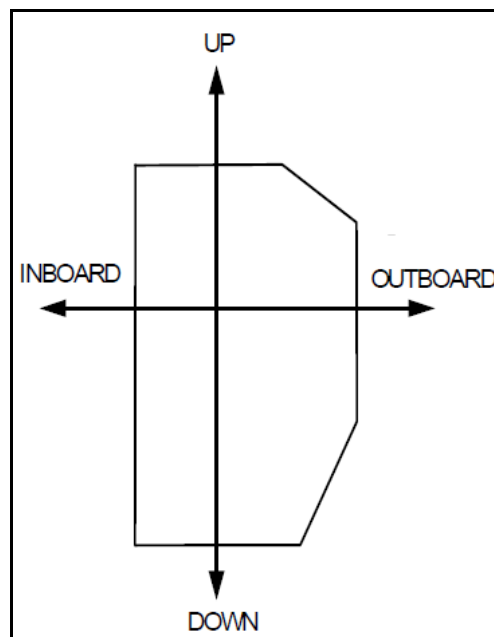

Figure 4-24: General Load Factor Envelope [48].

- **General Loads:** Interface pre-load, blast pressure, recoil of weapon firing, launch or jettison, and temperature effects should also be considered.
- **Forces of Interaction:** Any other interaction forces should be taken into account if applicable.

After determining applicable load envelope, store components should be verified under the loading conditions by using analytical and/or experimental methods. Loads applied to the store can also be harmful for the platform. Maximum possible loading configuration should be lower than the platform structural limits.

## 4.4.2 Ground Tests

### 4.4.2.1 Physical Fit and Functional Tests

Any store should ensure the physical interface requirements of proper station on aircraft. Physical fit tests are executed in very first stage of certification testing. It can be considered as the starting point of the ground



tests in certification process. Although it is simple compared to other stages of certification process, it plays a fundamental role to observe and understand:

- Store installation requirements;
- Clearances to aircraft, landing gears, other stores, etc.;
- Accessibility for maintenance and adjustment;
- Sway bracing;
- Ejection or displacing; and
- Safety.

Clearances are well described in MIL-STD-1289D1 [49] standard. Early physical fit tests can be done before finalizing the design of store, to check physical interfaces with the carrying platform. Experiences obtained from fit check studies are used as first inputs to loading procedure documents. Images from a physical fit check test are given in Figure 4-25.



**Figure 4-25: Physical Fit Check.**

Functional tests are the first electrical tests of store, if applicable. It checks the compatibility of store with aircraft in terms of electrical interface, all ground and flight modes (needed to be done at System Integration Lab) and armament. This test can also be evaluated as a preliminary store and aircraft OFP's communication test.

For the electrical interface test, all the connections between store and aircraft should be checked and there must be no short circuits, grounding issues or cabling failures to affect aircrafts electrical system. For the store functional test, validation and verification of store software is also included. This test needs some simulated flight environment to check store/aircraft communication. For the armament control, power sources, functioning mechanisms of store and release/firing mechanisms had to be checked, in order to ensure functional compatibility (Figure 4-26).



Figure 4-26: OFP Validation Test.

#### 4.4.2.2 Static Ejection Test

Static ejection is one of the essential pre-flight test procedures that allow monitoring functionality of lanyard, separation characteristics and arming system. This type of testing, allows engineers to evaluate how:

- Aircraft is physically affected by release of store;
- Store on-board computer works; and
- Store components are affected by mechanical shock loads.

Especially following data are very important for evaluating airborne ejections:

- Ejection force;
- Ejection velocity;
- Acceleration; and
- Pitch, yaw and roll rates.

These data could be collected by accelerometers, strain gauges or photographic records. This test basically consists of two different observation areas. First one is more mechanical interfaces that interested in forces on aircraft, pylon, store and store acceleration rates. These measurements could be essential for airborne separation analysis. Of course, differences due to external flow, outside temperature should be considered.

Second area is much more related with electrical (in some manner electronics) interfaces. When trigger signal is send, how long it does hold, how much time it takes for store to allow separation (mostly depends on rise time of store internal power sources), and time of separation are critical parameters to identify and understand separation. Also voltage levels might be measured to identify and clarify the future problem sources.

As a kind remainder, to use big and soft enough pillows for store landing would be very helpful, if reuse is considered or store is valuable. Some test pictures are shown in Figure 4-27.





Figure 4-27: Static Ejection Test.

#### 4.4.2.3 Ground Vibration Test (GVT) – “Big” Modal Test

Ground Vibration Testing (GVT) is mainly “big” size modal testing performed on an aircraft structure. However, the practice of modal testing is more of an art than a science in many respects. There is no single right way to perform a modal test. The supporting systems, excitation sources or the transducers will influence the dynamic behavior of the structure. The “magic” of modal testing is to obtain results that are close to the “correct” answer. There is no recipe for a successful modal test. The object of the modal testing is to acquire sets of Frequency Response Functions (FRFs) that are sufficiently extensive and accurate to enable analysis and extraction of the properties of all the required modes of the structure. Modal analysis is a sub-title of structural dynamics where system identification methods are applied to obtain modal parameters of an engineering structure. There are two types of modal analysis named as Classical (or Experimental) Modal Analysis (CMA or EMA) and Operational Modal Analysis (OMA). CMA involves exciting the structure by means of known forces (either using shakers or impact hammers) and measuring the response to these forces over the structure (usually by means of accelerometers). The system/structure is then characterized (estimation of unknown modal parameters) on the basis of both the known input forces and output responses. Operational Modal Analysis (also called Output-Only Modal Analysis, Ambient Testing, or In-Operation Modal Analysis) is an extension of classical modal analysis used in cases where it is not possible (or not feasible) to excite a structure by known forces. There are undeniable advantages of examining a structure in its operating conditions. Firstly, the set-up time is significantly reduced, since only transducers for response measurements are used, and no excitation source is utilized. Secondly, the measurements obtained represent the real operating conditions, boundary conditions, etc., unlike laboratory testing cases generally. There are numerous time and frequency domain methods for both types. In modal testing, there are three major items for the measurement system which are:

- Excitation mechanism;
- A transduction system to measure the various parameters; and
- An analyzer to obtain the desired information from the measured data.

Although there is a need to use excitation mechanisms in classical modal testing, in operational modal testing, since there is no necessity to know the forcing, it is not required a special excitation mechanism generally.

For the excitation of the structure, generally two types of excitation sources are used in classical modal testing. For OMA, as explained in detail in previous part, the excitation force does not measured or controlled or the structure is investigated in its operational conditions. If the operational modal testing will be performed by exciting the structure, similar excitation sources can be used as the classical modal testing.

Otherwise, the structure could be tested in its operating conditions. The excitation sources are generally instrumented impact hammers and electro-dynamic modal shakers. Impact hammer is a tuned device that eliminates hammer resonances from corrupting the test data resulting in more accurate test results. Modal shaker or modal exciter is such a device that it creates vibration force by changing the direction of the magnetic field continuously. Sometimes, test crew may need special excitation sources such as rotating wing-tip vanes, electro-magnetic bearings, low-frequency exciters, drop-weights, unbalanced shakers, pyrotechnics and control surface input sources.

For the testing, the excitation can be transient, random (continuous, burst or periodic) or sinusoidal (sine or swept-sine). Typically, transient excitation is applied using an impact hammer, whereas random and sinusoidal excitation is applied using one or more shakers. Hammer testing is faster than shaker testing. Only a few averages are typically required at each excitation DOF. A minimum amount of equipment is needed and the test set-up is simpler than for any other classical excitation method. It is ideal for troubleshooting; field-use, infrequently performed tests, or as a preliminary investigation of a structure's dynamics and for selection of the best excitation DOFs before a full-scale shaker test is performed. Hammer testing is limited to producing impact pulses. There is limited control of excitation bandwidth, though there is some ability to optimize the frequency content of the impact pulse by changing hammer tip (plastic, rubber or steel) and adding an extender mass.

Shaker testing enables the use of a wide variety of easily controllable excitation signals. High force ratings are attainable and it is possible to perform simultaneous, multi-point excitation. Shaker testing requires, however, more elaborate fixturing of the structure and shaker. The test engineer should use force transducer to control the vibration input to the structure. Consequently, shaker testing choice is most commonly used in setups for frequently performed tests. In shaker testing, an adaptor called stinger or tension wire is used to perform the structural connection between the structure and the shaker. Some dynamic loading, e.g. force drop-offs at resonance frequencies from the shaker/stinger systems is unavoidable in shaker testing.

Ground Vibration Testing (GVT) is an essential preliminary ground test that must be conducted prior to the beginning of flight testing. The objective of the GVT is to obtain aircraft structural mode characteristics such as frequencies, mode shapes and damping. It is done to verify and update the aircraft analytical flutter model as well as provide a means of identifying modes from the frequencies found in flight test data. A GVT is not only required for new aircraft designs but also when extensive changes are made to existing aircraft or when new store configurations are added.

A basic GVT consists of vibrating the aircraft at a number of different frequencies and measuring the response at various locations on the aircraft. Usually several hundred response stations are monitored in order to fully define the aircraft's modal characteristics. The response signals are processed through signal conditioning amplifiers and passed on to high-speed computers for data manipulation and analysis. The structural responses are most often sensed with accelerometers attached to the surface of the aircraft. The accelerometers are generally evenly distributed over one side of each aerodynamic surface (i.e. wings, horizontal and vertical tails, and control surfaces), and are also located at critical stations on the fuselage, engine nacelles, and pylon or stores. The effect of mounting type of the accelerometers is given in [50] and [51].

The excitation of the aircraft is generally produced by electro-mechanical shakers. These are essentially electric motors which cause a center armature to translate up and down as a function of applied current. The armature of the shaker is attached to the structure of the aircraft by a sting. A force link is usually attached to the sting to measure input vibration force data for use in transfer function analysis. Generally more than one shaker is used and they are attached to the aircraft at its extremities such as the wing tips, vertical and horizontal tail tips and on the fuselage nose or tail. The shakers can be operated in and out of phase with each other to generate symmetric and anti-symmetric inputs, respectively, using either random or sinusoidal wave forms. A guide for shaker excitation is given in [52].

It is generally necessary to suspend the aircraft from a soft support system in order to separate the rigid body modes from the elastic vibration modes. This is done by suspending the aircraft on vibration isolators such as air bags or soft springs. In some cases sufficient suspension can be provided with the aircraft resting on its landing gear by simply reducing the pressure in the tires and gear struts. This generally can only be done if the landing gear is attached to the fuselage and not to the wing.

A number of different excitation techniques are used during a GVT. Swept sine waves or random excitations are used to determine broad band frequency response characteristics. Based on these characteristics, discrete frequencies are selected and a sine dwell excitation is performed at each frequency to generate mode shape data. Often the sine dwell is stopped abruptly and the decay of the resulting transient response is measured to obtain damping. Current modern data processing frequently allows obtaining modal frequencies, mode shapes, and damping all from a single random excitation by simultaneously processing multiple input forces and output responses.

The products produced from GVT's include structural response frequencies, mode shapes and damping values. The data is presented in the form of frequency response plots (amplitude and phase versus frequency), animated mode shapes and a listing of damping values for each mode. Information as to the validity of the modal data is also presented in the form of orthogonality and reciprocity checks and coherency plots. This data is used to update the vibration, flutter and aeroservoelastic predictions necessary to support flight testing.

The aircraft should be as close structurally to the final flight-ready configuration as is practical otherwise the modal data obtained will be misleading. The soft suspension system must be capable of not only supporting the weight of the aircraft but must reduce the value of the highest rigid body frequency to less than one third of the lowest elastic frequency. Generally the aircraft hydraulic system must be on to activate the control actuators or the control surfaces must lock in place. The excitation system typically must be capable of several input force levels. The accelerometers and force cells must be sized for the level of responses expected and yet be small enough not to add appreciable mass to the structure or shaker armature. There should be a sufficient number of strategically placed accelerometers on the aircraft to accurately map the mode shape for each structural mode. The response stations where the accelerometers are located must correspond to the node points used in the analytical vibration or flutter model in order to correlate GVT results with analysis [53].

The earliest ground vibration test goes back to space shuttles. The Space Shuttle Enterprise (NASA Orbiter Vehicle Designation: OV-101) which was the first space shuttle orbiter subjected to a series of ground vibration tests in 1978 (Figure 4-28) [54]. Images from a more recent test performed on F-16 A/C are shown in Figure 4-29.

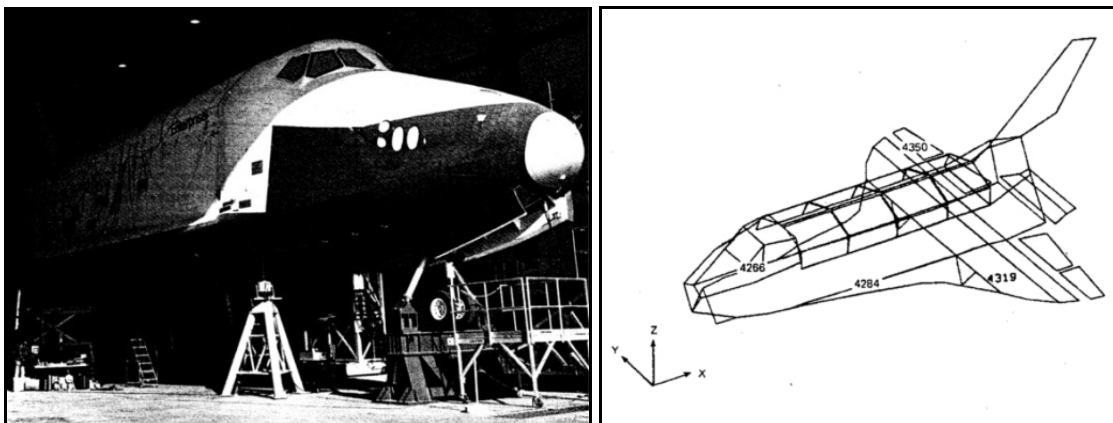
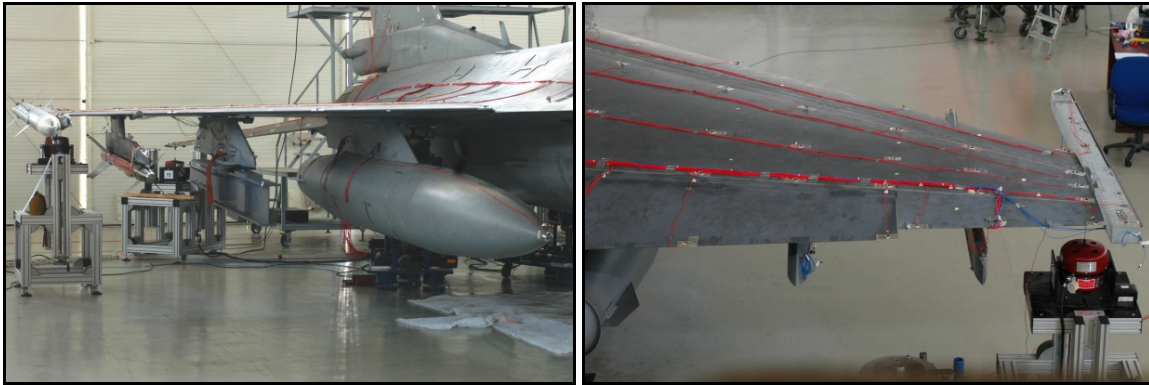

Figure 4-28: The Space Shuttle Enterprise Ground Vibration Test [54].



**Figure 4-29: Ground Vibration Testing of Munition Under Development.**

NASA Langley Research Center and Dryden Flight Research Facility performed the ground vibration test to a modified Firebee II target drone vehicle fuselage with a NASA designed research wing, ARW-1, which was a sweptback, supercritical airfoil with a performance design point of 0.98 Mach at 45000 ft. (13716 m), to be able to investigate the aeroelastic effects in the high subsonic speed range. The natural frequencies and mode shapes are identified in the study [55].

The U-8F which is the designation of the Beechcraft Queen Air models 65 and A65 is tested for engine, propeller and engine mount truss assembly modifications. The aircraft is tested using sine-dwell, single point random and impact excitations [56]. Main issues of ground vibration testing are reported in reference [57]. This report is the updated version of reference [56]. A modified version of F-18 aircraft to conduct flight research at high angles of attack is tested to determine the effects of these modifications on the modal characteristics of the airplane and to acquire data to update the Finite Element Model (FEM) used in the aeroelastic and aeroservoelastic analyses. The airplane was mounted on the airspring-pendulum soft support system and the response of the airplane was measured at 193 points. X-31 aircraft which is a single-engine experimental airplane with 17 control surfaces including 3 thrust vectoring vanes about the exhaust of the engine is also tested. The amount of control surface free play and its effect on the aeroelastic stability was a concern for this airplane. Another application of ground vibration test is applied on an F/A-18 aircraft to check the functionality of the accelerometers that are built in for flight testing [58].

Finite Element (FE) model of the test item is useful in the preparation stage of ground vibration testing. A report about experiences gained in the preparation stage and GVT research on an Airbus A340-300 is given in [59]. The detection of deviations of the measurements from the analytical model might influence the test procedure drawing attention towards the least precisely predicted modes which can prove to be very useful for the updating of the FE model. The necessity is a proper association of the test data with the analytical calculations. For this task the use of a generalized static expansion technique is recommended in this reference.

Detailed finite element model of the test item may not be available. Ground vibration testing and flutter analysis of a small composite aircraft is given in [47]. In that study, besides the ground vibration testing of the aircraft, flutter analysis technique is also shown. Since, detailed finite element model of the test item is not available, modal model of the aircraft is used for the flutter analyses. After the certification of the aircraft, ground vibration test is repeated due to some structural modifications [60].

There are number of different analysis procedures in the literature. In reference [45], Frequency Domain Direct Parameter Identification (FDPI), the Least-Squares Complex Exponential (LSCE) method, and the Least-Squares Complex Frequency Domain (LSCF or PolyMAX) method are investigated with respect to their applicability to test data from GVTs of large aircraft. The influence of statistical errors such as noise contamination and systematic errors (e.g. due to stiffness and damping non-linearities) are also studied using



an analytical 5-DOF system to assess the degree of accuracy which can be achieved for the modal parameters. After that, the methods are compared by using Airbus A380-800 GVT data. It is concluded that it is extremely difficult to assess from the basic equations which method performs better in certain conditions. However, it is admitted that LSCE and LSCF can be used for broadband modal analysis, whereas FDPI can sometimes not achieve stability for structural poles when the analysis bandwidth is too broad. LSCF provides clear stabilization diagram, which is the most commonly applied tool to identify poles that are repeatedly plotted for different model orders used for parameter identification, also in the case of noise-contaminated FRFs. However, the damping estimates associated with the few stable poles decrease with increasing noise levels. It is also concluded that it is not sufficient to rely on the results obtained with a single modal analysis tool. The results obtained with different modal analysis tools should rather be checked against each other if the results of modal analysis are suspicious. Application of these methods to Airbus A340 airplane is given in [61].

When modal parameter estimation strategies are investigated, they are categorized as phase separation (FRF-based) methods and phase resonance methods [46]. For more than 3 decades, the use of the Phase Resonance Method or so-called Normal Mode Testing has been almost exclusively required for GVT on large aircraft because this method is generally well suited for the separation of closely spaced modes. Although real (normal) modes of the corresponding un-damped structure are directly measured, it is a very time-consuming testing procedure. Therefore, the phase resonance method is complemented and partially substituted by so-called phase separation techniques that find the aircraft modes by evaluating FRF. Phase separation techniques are faster. Random, swept and stepped sine signals are used for phase separation techniques, and sine signals are used for phase resonance testing. The combination of these techniques is used in Airbus A340-300 and A340-600 [62]. Another study on A340 is given in [63].

In one of the studies [64], a new sine excitation technique of phase separation techniques is suggested. To be able to get high-quality FRFs by using stepped sine excitation techniques, it is necessary to concentrate the excitation energy at a single frequency and excite the structure at much higher energy levels in feasible time period. A new Multi-Input Multi-Output (MIMO) sine testing technique has been developed that allows getting the high excitation levels (and resulting high-quality FRF data) of a stepped sine technique, but at drastically reduced measurement times. All exciters are driven by the same instantaneous frequency. Multiple averages with uncorrelated inputs are required in order to calculate correct FRFs. This is achieved by defining multiple sweeps with different phase relations between the different exciters. The new technique was compared with the traditional burst random and stepped sine techniques. It was proven that this technique is able to measure FRF and coherence functions of similar high quality as the stepped sine technique, but at drastically reduced measurement times, which are comparable with the burst random technique.

The variety of modal analysis techniques that are operational modal analysis techniques are tried to be adapted for ground vibration testing. Since it is the aircraft manufacturer's goal to make aircraft development more cost-effective, the researchers performed a study on a test rig simulating the conditions of an aircraft during taxi. Modal parameters are identified from vibration measurements using an OMA procedure in [65]. A replica of the GARTEUR SM-AG19 structure equipped with nose and main landing gear is used as the test. A band conveyor was utilized to simulate the taxi runway. Small bumps were irregularly installed on the course to suppress periodic excitation introduced by the unbalance of the tires. In order to establish results that could be used as a reference; a conventional modal test was carried out using a single input random excitation. Except for a single structural mode and three landing gear modes, all extracted Eigen frequencies and corresponding mode shapes could be paired between OMA and GVT. Even very closely spaced modes have been identified very clearly. One significant idea stemming from this work is to utilize taxi vibration test results in the certification process of a new aircraft.

The researchers investigated different types of in-flight excitation sources on a real large aircraft [66]. Some modern frequency-domain modal parameter estimation methods are applied to in-flight data of a large

aircraft. Traditional sine sweep excitation was applied at the control surfaces. However, during the test the aircraft passed through a turbulent zone. After quitting the turbulent zone, the sweep test was reinitiated. Large uncertainties are related to the damping ratio. The damping ratios which are very crucial for the flutter analysis are comparatively different depending on the data pre-processing, parameter estimation method and the used data.

Least-squares complex frequency results are compared to results from stochastic sub-space identification in [67] for the operational data of a business jet. It is shown that least-squares complex frequency method yields accurate modal parameters with clear stabilization diagrams much easier than stochastic sub-space identification.

Technology evolution of operational modal testing is given in [68]. Stochastic time series modeling which use output time histories; e.g. ARMA models are said to be not practical (time-consuming, numerical problems) for OMA. There are not any convincing cases in literature either. Although other time series based sub-space identification methods [Balance Realization (BR), Canonical Variety Analysis (CVA)] are successful in applications, their samples/channels number is limited so they cost large computation time. In other words, they do not seem to be relevant in modal analysis applications. When frequency domain methods are investigated, they are separated as parametric and non-parametric methods. Parametric means that a model is fitted to the data. Parametric methods have the great advantage that stabilization diagrams can be used to objectively find the modes. Non-parametric means that just some signal processing techniques are used (FFT, SVD, etc.) to enhance certain signal features (frequency domain peaks). In the peak-picking and SVD-based methods, the user has to select modes based on some peaks in spectra. SVD-based methods (the SVD step allows to approximately separate modes) are sometimes complimented with SDOF curve-fitters, but this is a time-consuming and highly-interactive process. It is also shown that application areas are extended to civil, aerospace and automotive industries. The application of these techniques on a transport airplane is described in [69].

Modeling of ground vibration testing by using finite element formulation can be found in [70]. A general configuration that can be represented as a collection of non-linear beam finite elements is modeled. The formulation is generated for highly flexible aircraft. The vehicle is modeled by a collection of geometrically exact, non-linear intrinsic beams suspended from bungee cords. Here the term “intrinsic” refers to the special characteristic of a formulation to be without displacement and rotation variables. Bungee cord is used as the suspension system for the formulation. It is shown that the deformed shape of highly flexible wings significantly affects the modal characteristics, especially for some low-frequency structural modes. The deformed shape needs to be considered in the aeroelastic analyses of highly flexible aircraft for accurate analysis. The consideration of non-linearities in the aeroelastic stability certification processes is becoming more and more important. If non-linearities are considered in the test strategy, the experimental acquisition of the non-linear vibration characteristics can be accelerated. The aeroelastic behavior of highly flexible structures such as large aircraft cannot be sufficiently described on the basis of linear models. A new procedure for the detection of non-linearities are shown and discussed in [71] with regard to their application during industrial large-scale testing.

#### **4.4.2.4 Wind Tunnel Tests**

Wind tunnel testing is one of the major steps during a design process. The quality of computational predictions can be evaluated and final aerodynamic characteristics of the vehicles can be obtained prior to flight tests with the help of wind tunnel testing. Moreover, during the certification of air-launched stores, additional wind tunnel tests should be executed according to MIL-HDBK-1763 [5]. This section defines potential wind tunnel test requirements of stores for aircraft integration.

There are several test types that should be executed during an integration project. According to MIL-HDBK 1763 [5], scope of wind tunnel tests comprise 4 major sections which are listed below:

- Effects of aircraft on captive stores/suspension equipment;
- Effects of captive stores/suspension equipment on aircraft;
- Aeroelastic effects test; and
- Separation tests.

Details, test input and measurement device requirements should be determined according to the tests to be executed. The input details and aim of these tests are presented in subsequent sections. Sample pictures of wind tunnel testing items are presented in Figure 4-30.



**Figure 4-30: Wind Tunnel Testing Examples.**

*4.4.2.4.1 Effects of Aircraft on Captive Stores/Suspension Equipment*

The purpose of effects of aircraft on captive stores/suspension equipment test is to define the aerodynamic influence of the parent aircraft on the store/suspension equipment. The data required are the aerodynamic forces and moments acting on the captive store/suspension equipment as a function of Mach number, aircraft orientation, attitude and configuration characteristics, usually disregarding aeroelastic effects. Data that has to be collected and instrumentation needed is given in Table 4-1.

**Table 4-1: Wind Tunnel Data and Instrumentation Requirements.**

DATA TYPE	INSTRUMENTATION
Local distributed loadings on store or suspension equipment	Pressure(s) transducers
Net reaction loads	Strain gauge balance(s) <sup>1/</sup>
Temperatures, aerodynamic heating	Thermocouples, phase change paints, liquid crystals, heat transfer rate gauges, thermographic phosphor
Flow visualization, local shocks, flow separation	Oil on surface, smoke (smoke tunnel needed) – Schlieren shadowgraph
Acoustic phoneme	Dynamic response pressure transducers
<sup>1/</sup> One of the prime factors to consider when using strain balances is to ensure that the loads to be experienced in the tunnel are within the range of the force(s) being measured, i.e. the data are not within the error scatter band of the balance.	



#### 4.4.2.4.2 *Effects of Captive Stores/Suspension Equipment on Aircraft*

The purpose of effects of captive stores/suspension equipment on aircraft test is to evaluate the influence of stores/suspension equipment on the aerodynamic characteristics of the aircraft. The user's primary objectives usually involve determining the aircraft performance or stability and control effects due to the addition of store/suspension equipment. These effects can cause the aircraft performance, stability and control characteristics to change due to increases in aircraft total drag, coupled with shifts in aircraft center of gravity and neutral point. The purpose of a performance and stability and control wind tunnel test is to obtain aerodynamic coefficients necessary to estimate performance, stability and control characteristics of an aircraft with carriage of external stores. In addition to basic performance, stability and control, if the aircraft may carry stores during Air Combat Maneuvering (ACM), some more specialized wind tunnel tests such as rotary balance, free spin and other small-scale model tests may be required. These tests define flight characteristics of a configuration at high angles of attack, both in and out of controlled flight.

When considering weapons bays, the aeroacoustic environment of both the store(s) and the cavity must be considered. Extremely high resonant peaks and high overall turbulence can cause structural fatigue and vibration, as well as avionics malfunctions.

#### 4.4.2.4.3 *Aeroelastic Effects Test*

Wind tunnel tests are performed on dynamically scaled models of the aircraft-with-stores to experimentally determine the airspeed, frequency, and modal shape of potential aeroelastic instabilities caused by the addition of external stores.

For this purpose, flexible models of the aircraft-with-stores are used in which the geometric shape, mass and stiffness distributions are dynamically similar to the airplane and scaled to the tunnel's operating conditions. These models, with proper construction and instrumentation, are intended to simulate any aeroelastic instabilities, and are known as flutter models. These tests are performed to verify analytical predictions of aeroelastic instabilities such as flutter. For verification tests, the models are usually tested at increasing tunnel speeds until instability occurs or the tunnel limits are reached. Tests are often performed only up to 1.15 times the limit speeds, unless instability should first occur, in order to reduce the risk of model destruction.

Extensive flutter model tests may be conducted in low-speed wind tunnels with reasonable economy and assurance of accurate results especially when compressibility and Mach number effects are known to be insignificant. These models are dynamically scaled so that the lower dynamic pressures and airspeeds experienced in the low-speed tunnel represent proportionally much greater values for the aircraft. When compressibility effects may become important (usually above aircraft Mach numbers of about 0.70), limited verification tests may also be conducted in transonic facilities with flutter models that match aircraft Mach numbers in addition to being scaled for other dynamic aeroelastic properties. However, transonic flutter model testing is much more difficult, time consuming, and more expensive than low-speed testing. Special purpose flutter model tests may be appropriate especially when analytical approaches are lacking. One such type of test is to determine the effect of partially filled fuel tanks on flutter. Another type of test may very efficiently use a remotely controlled variable-inertia flutter model to conduct broad ranging parametric studies of the inertia effects on flutter. Wing tip mounted stores pose special analytical problems which may be resolved by wind tunnel testing. Tests using half span flutter models may sometimes be used to reduce costs and increase testing efficiency or to avoid the inevitable small structural asymmetries of full-span models. However, half-span models do not simulate fuselage flexibility and, if important, this must be investigated in other ways, such as full-span flutter models.

#### 4.4.2.4.4 Store Separation Tests

Store separation tests are conducted to determine the safe separation envelope of the store under aircraft flow field effects. These tests should include level, dive and toss release conditions. There are 3 different wind tunnel test techniques that can be used in the wind tunnel.

##### 4.4.2.4.4.1 Captive Trajectory System (CTS) Tests

Captive Trajectory Simulation (CTS) system is a specialized model support system that is designed for store separation problems. A CTS system is a support system that moves the store to a new position by using 6-DOF solver according to the measured forces on the store itself.

6-DOF rigid body solvers integrate the forces and moment measured on the body to calculate the linear and angular speeds and rates in this method. As attitude and position and the velocity of the store are calculated, store is moved to a new attitude and position with the 6-DOF support system. Continuous measurement, calculation and replacement of the store model allow estimation of the store trajectory.

CTS system often consists of Two Sting Rig (TSR) system that allows attaching aircraft model and store model at two separate supports, therefore both models moves independently (Figure 4-31). After flight conditions are determined, simulation store model is located at the end-of-stroke position with an attitude that mimics the store wind axis. Estimation of the flow parameters at a given simulation step is done in real time with various methods. Measured flow parameters may be corrected in several ways, such as dynamic parameter corrections may be added, scale or base drag corrections can also be applied on the flow parameters.



Figure 4-31: CTS System.

##### 4.4.2.4.4.2 Free Drop Tests

Free drop test is the simplest idea to perform a store separation simulation in a wind tunnel. A scaled test model is simply dropped from a scaled aircraft in the wind tunnel. However, application of the test consists of considerable challenges. Free drop test requires the simulation of forces from fluid flow and the weight (inertial and gravitational forces). Therefore Froude similarity should be met.

These conditions require accurate production of the test model. It should be noted that, for each critical altitude, test model should be reproduced as the air density changes. This yields in very fine production of many test models, considering also that these models can be very fragile to sustain drops.

The other requirements of the free drop test are an accurate scaled ejector system, which can be adjusted with the altitude condition, and a camera system with a high frame rate. Separation of the store model is captured by the cameras and the path and the attitude of the store is calculated as it is done in aircraft tests and the assessment of the safe separation is done accordingly.

The equipment used in drop tests is relatively cheap compared to other wind tunnel alternatives and there is no need to develop dedicated simulation codes. Depending on the number of tests necessary to ensure the safe separation in entire envelope, drop tests is a viable option at the final design stage. It should be noted that in the case of the change of the store weight of center of gravity during the design phase, store model should be re-adjusted or reproduced and wind tunnel tests should be repeated.

#### 4.4.2.4.4.3 Grid Tests

Grid tests are based on the idea to measure the aerodynamic force and moment parameters on a domain under the aircraft and interpolate those parameters at any given point in this domain to be used a posteriori store separation simulations.

The same two sting rig model support system is used for constructing the grid data under the influence of the aircraft. Depending on the requirements of the simulation and complexity of the flow field, an estimated trajectory of the store is scanned at several lines repeatedly for different store attitudes. These scans constitute a grid of position of attitude of store keeping the flight parameters at each grid point.

Paths scanned by the CTS often form a pyramid or a half-pyramid with the crest is attached to end-of-stroke position. Although the method employs the same apparatus, the procedure of the grid tests differs with the CTS in a couple of ways:

- Grid tests require a lot of traverses compared to CTS tests. For example in a grid consisting of five paths and three pitch and three yaw combinations, 45 traverses are necessary to complete one grid. Considering that modern computers are fast enough to perform 6-DOF rigid body simulation almost real time, grid test requires considerably more wind tunnel time compared to the CTS tests, therefore grid test is more expensive.
- Grid test employs a posteriori 6-DOF simulation while CTS employs real-time simulation. Therefore grid tests should be planned in such a way that the grid is detailed enough to estimate flow parameters for a given store separation condition.

Also it should be noted that in the perspective of 6-DOF simulations, at a given point 6-DOF solver employs variables interpolated from the grid for grid method instead of variables measured at that point for CTS tests. Although it seems like grid tests are less accurate and more expensive than CTS tests, they have certain advantages:

- A posteriori simulations allow integral configuration changes during design changes or upgrade studies are tested without repeating the tests. This is a frequent situation for a store in design phase. Often the weight of center of gravity of the store is changed during the design phase, which alters the behavior of the store after release. All the other simulation methods require repeat of the store separation tests, while grid test data can be reused in the rigid body motion simulation provided that external geometry is not altered.
- Grid tests allow coupling simulations of more complex phenomena with the external aerodynamics of the store, such as sloshing simulation or autopilot coupling, which is not available in other wind tunnel methods.

For certain conditions, it is possible to interpolate between different grid test results to perform store separation simulations for conditions where grid tests are not available. This is useful when fine tuning the safe separation envelope.

#### 4.4.2.5 Environmental Tests

Environmental tests is the process of determining the ability of materiel(s) to withstand and operate reliably when influenced by the various environmental factors and levels it is expected to experience throughout its service life.

Prior to 1940 the importance of the environmental testing did not be known as it is known today. World War II raised awareness of the environmental testing. During the war years, storage and operation at the arctic, desert and jungle climate and improper packaging, handling and transportation resulted excessive damage to materiel(s). These failures caused qualification of new devices in appropriate environmental conditions.

Development of the environmental testing process started with few standard procedures for performing tests. Since then a lot of test specifications and procedures for the materiel and its operational area were issued. MIL-STD-810 versions which are developed for the aerospace and ground equipment became the main standard for the environmental test methods. Latest version of this standard is MIL-STD-810G [36] which includes 29 test methods. Test methods vary from thermal tests to dynamic tests and some combined test methods. Some of the major test methods and their purpose are explained below.

Low and high temperature testing help to determine the effects of extreme temperature conditions on materiel safety, integrity and performance. Operational effects may not cause a system to fail, but it can prevent it from fulfilling its mission. For example, snow and ice prevent an aircraft from taking-off even though all systems function perfectly. An example of low temperature test is given in Figure 4-32.



**Figure 4-32: An Example of Low Temperature Test.**

Low pressure testing became very important with the innovation in aircraft industry. This test method helps to determine if material can withstand/operate in low pressure (high altitude) (if appropriate low temperature also) environment and/or withstand rapid pressure changes. Temperature shock test is using to determine the effects on aerospace and ground equipment of sudden changes ( $> 10^{\circ}\text{C}$ ) in temperature of the surrounding atmosphere. Especially aircraft materials may be exposed to the heat of the desert, tropics and sun on the ground and a few minutes later exposed to the extreme low temperatures of high altitude.

Humidity test example which is an accelerated environmental test is given in Figure 4-33. The purpose of this test is to determine the resistance of test items to the effects of a warm and humid atmosphere.



**Figure 4-33: An Example of Humidity Test.**

Vibration test is used to determine the susceptibility of aerospace and ground equipment to the dynamic stresses encountered in transportation and operational use. These tests include vibration due to aeroacoustic environment which is produced by engine noise, general aircraft vibration transmitted to the store through the attaching structures and airframe buffet, and the aeroacoustic environment within open bays. Except from this test methods MIL-STD-810G [36] include contamination by fluids, solar radiation, rain (including windblown and freezing rain), fungus, salt fog for rust testing, sand and dust explosive atmosphere, immersion, acceleration, acoustic noise, shock, pyroshock, acidic atmosphere, gunfire shock, ballistic shock, freeze/thaw, time waveform replication, rail impact, multi-exciter, mechanical vibrations of shipboard equipment and two combined tests methods which are temperature/humidity/vibration/altitude and vibroacoustic/temperature test.

The important point for these tests is the test conditions which verify the materiel(s) should reproduce the expected service life exposure levels and times. Because of that reason if it is appropriate, measurement of the field data and determining test levels with this field data is the most preferable way to perform tests. If it is not appropriate to measure the field data, measurements of the similar conditions with special considerations can be used for to determine test levels. If these measurements are not available, the estimates of environmental base on MIL-STD-810G [36] can be used.

Nowadays because of the importance, environmental tests have become obligatory in many fields.

#### 4.4.2.5.1 *Vibration and Shock Test*

Vibration testing is the process of applying a controlled amount of vibration to a test specimen, usually for the purposes of establishing reliability or testing to destruction. In practice the test article is securely mounted on a shaker table or actuator [72]. Consumers expect and demand products of high quality and reliability. To fulfill these requirements we must consider vibration, since at some time in its life the product will be subjected to vibration. Poor mechanical design will result in mechanical failure and customer dissatisfaction which will add cost and reduce credibility [73].

An environmental specification is a written document that details the environmental conditions under which an item of equipment to be purchased must operate during its service life. An environmental test specification is a written document that details the specific criteria for an environmental test, as well as other matters such as the preparation of the test item, identification of all test equipment and instrumentation, description of any test fixtures, instructions for mounting sensors, step-by-step procedures for operating the test item (if operation is required), procedures for taking data on the test item function and the applied environment, and performance acceptability criteria. The test criteria (the magnitude and duration of the test excitation)



in environmental test specifications often serve as design criteria as well. Vibration and shock environments may result from the equipment operation (for example, the vibration caused by shaft unbalance in equipment with a rotating element), but it is the external shock and vibration motions transmitted into the equipment through its mounting points to the structure of the system. The original source may also be a direct motion input to the system, for example, earthquake inputs to a building or road roughness inputs to an automobile. Such environments have complicated transmission patterns that are modified or intensified by mechanical resonances of the system structure and, therefore, are appropriately described by frequency-dependent functions, i.e. spectra. In practice, for economy of effort, equipment is often designed and tested for exposure to multiple environments; however, some of the environments may occur simultaneously and have an additive effect. Worse yet, two environments may have a synergistic effect; for example, equipment may be subject to high vibration during a period when the temperature exposure is also high, and high temperatures cause a degradation of the equipment strength, making it more vulnerable to vibration-induced failures. These matters must be carefully evaluated during the definition of a test program to determine if simultaneous testing for two or more environments is required [74].

From a testing viewpoint, it is important to carefully distinguish between a shock environment and a vibration environment. In general, equipment is said to be exposed to shock if it is subject to a relatively short-duration (transient) mechanical excitation; equipment is said to be exposed to vibration if it is subject to a longer duration mechanical excitation. If the basic properties of the vibration are time invariant, it is called stationary (or steady-state for periodic vibrations). However, vibration environments are often non-stationary, i.e. one or more of their basic properties vary with time. If the properties change slowly relative to the lowest frequency of the vibration, then the vibration can be analyzed to arrive at criteria for a stationary vibration test [74].

The vibration environment for an item of equipment usually varies in magnitude and spectral content during its service life. For reliability tests discussed later in this chapter, it may be necessary to measure or predict the spectra of the vibration environment for all conditions (or a representative sample thereof) throughout the service life and to formulate test criteria that require a series of tests with several different magnitudes and spectral content. For most testing applications, however, a test involving a single spectrum is desired for convenience. To assure that the test produces a conservative result, a maximax spectrum is used; a maximax spectrum is the envelope of the spectra for all conditions throughout the service environment. Thus, the maximax spectrum may not equal any of the individual spectra measured or predicted during the service environment, since the maximum value at two different frequencies may occur at different times [74].

An environmental test is any test of a device under specified environmental conditions (or sometimes under the environment generated by a specified testing machine) to determine whether the environment produces any deterioration of performance or any damage or malfunction of the device; an environmental test may also be distinguished by the objectives of the test. In assessing the effects of shock and vibration on equipment, the types of tests most commonly performed fall into six categories named as development, qualification, acceptance, screening, statistical reliability and reliability growth [74].

A development test (sometimes called an analytical test) is a test performed early in a program to facilitate the design of a device or piece of equipment to withstand its anticipated service environments. It may involve determining the resonance frequency of a constituent component mounted inside the equipment by applying a sinusoidal excitation with a slowing-varying frequency (often called a swept sine wave test). Sinusoidal vibration is widely used as the excitation for development tests because of its simplicity and well-defined deterministic properties. In contrast, it may involve a more elaborate test to determine the normal modes and damping ratio of the equipment structure. A stationary random vibration or a controlled shock excitation with appropriate data reduction software can greatly reduce the time required to perform a more extensive modal analysis of the equipment. In either type of test, the characteristics and magnitude of the excitation used for the test are not related to the actual shock and/or vibration environment to which the equipment is exposed during its service use [74].

A qualification test is a test intended to verify that an equipment design is satisfactory for its intended purpose in the anticipated service environments. Such a test is commonly a contractual requirement, and hence, a specific test specification is usually involved. Preliminary qualification tests are sometimes performed on prototype hardware to identify and correct design problems before the formal qualification test is performed. Also, qualification test requirements might be based upon a general environmental specification. In some cases, the specification may require a test on a specific type of testing machine that produces a desired qualification environment. However, contracts usually allow deviations from the specified test levels and/or test durations in general environmental specifications, if it can be established that different test conditions would be more suitable for the given equipment. In any case, the basic purpose of a qualification test requires that the test conditions conservatively simulate the basic characteristics of the anticipated service environments. Some years ago, when test facilities were more limited, it was argued that shock and vibration environments for equipment could be simulated for qualification test purposes in terms of the damaging potential of the environment, without the need for an accurate simulation of the detailed characteristics of the environment. For example, it was assumed that random vibration could be simulated with sinusoidal vibration designed to produce the same damage. The validity of such “equivalent damage concepts” requires the assumption of a specific damage model to arrive at an appropriate test level and duration. Since the assumed damage model might be incorrect for the equipment of interest, there is a substantial increase in the risk that the resulting test criteria will severely under or over test the equipment. With the increasing size and flexibility of modern test facilities, the use of equivalent damage concepts to arrive at test criteria is rarely required and should be avoided, although equivalent damage concepts are still useful in arriving at criteria for “accelerated tests,” as discussed later in this chapter. Whenever feasible, qualification tests should be performed using an excitation that has the same basic characteristics as the environment of concern; for example, random vibration environments should be simulated with random vibration excitations, shock environments should be simulated with shock excitations of similar duration, etc. [74].

An acceptance test (sometimes called a production test or a quality control test) is a test applied to production items to help ensure that a satisfactory quality of workmanship and materials is maintained. For equipment whose failure in service might result in a major financial loss or personal injury, all production items are subjected to an acceptance test. Otherwise, a statistical sample of production items is selected, and each item is tested in accordance with an acceptance sampling plan that assures an acceptable average outgoing quality. In either case, there are two basic approaches to acceptance testing for shock and vibration environments. The first approach is to design a test that will quickly reveal common workmanship errors and/or material defects as determined from prior experience and studies of failure data for the equipment, independent of the characteristics of the service environment. For example, suppose a specific type of electrical equipment has a history of malfunctions induced by scrap-wire or poorly soldered wire junctions. Then, the application of sinusoidal vibration at the resonance frequencies of wire bundles quickly reveal such problems and, hence, constitute a good test excitation even though there may be no sinusoidal vibrations in the service environment. The second and more common approach is to apply an excitation that simulates the shock and/or vibration environments anticipated in service, similar to the qualification test but usually at a less conservative (lower) level [74].

A screening test is a test designed to quickly induce failures due to latent defects that would otherwise occur later during service use so that they can be corrected before delivery of the equipment, i.e. to detect workmanship errors and/or material defects that will not cause an immediate failure, but will cause a failure before the equipment has reached its design service life. Screening tests are similar to acceptance tests, but usually are more severe in level and/or longer in duration. If performed at all, screening tests are usually applied to all production items. Vibration screening tests are commonly performed with the simultaneous application of temperature cycling, a process referred to as Environmental Stress Screening (ESS). The vibration environment is sometimes applied using relatively inexpensive, mechanically or pneumatically driven vibration testing machines (often referred to as impact or repetitive shock machines) that allow little or no control over the spectrum of the excitation. Hence, except perhaps for the overall level, the screening



test environment generally does not represent an accurate simulation of the service environment for the equipment service, similar to the qualification test but usually at a less [74].

A statistical reliability test is a test performed on a large sample of production items for a long duration to establish or verify an assigned reliability objective for the equipment operating in its anticipated service environment, where the reliability objective is usually stated in terms of a Mean-Time-To-Failure (MTTF), or if all failures are assumed to be statistically independent, a Mean-Time-Between-Failures (MTBF) or failure rate (the reciprocal of MTBF). To provide an accurate indication of reliability, such tests must simulate the equipment shock and vibration environments with great accuracy. In some cases, rather than applying stationary vibration at the measured or predicted maximum levels of the environment, even the non-stationary characteristics of the vibration are reproduced, often in combination with shocks and other environments anticipated during the service life. The determination of reliability is accomplished by evaluating the times to individual failures, if any, by conventional statistical techniques [74].

A reliability growth test is a test performed on one or a few prototype items at extreme test levels to quickly cause failures and thus identify weaknesses in the equipment design. In many cases, the test level is increased in a stepwise manner to clearly identify the magnitude of the load needed to cause a specific type of failure. Design changes are then made and the failure rate of the equipment is monitored by either statistical reliability tests in the laboratory or evaluations of failure data from service experience to verify that the design changes produced an improvement in reliability. Unlike statistical reliability tests, reliability growth tests do not simulate the magnitudes of the service environments, although some effort is often made to simulate the general characteristics of the environments; for example, random vibration would be used to test equipment exposed to a random vibration service environment [74].

#### 4.4.2.5.1.1 Vibration and Shock Testing Machines

Various types of equipment are used for testing vibration and shock. Most commonly used types of vibration and shock machines are listed below:

- Direct-drive mechanical vibration machines;
- Reaction-type mechanical vibration machines;
- Circular-motion machines;
- Recti-linear-motion machines;
- Electro-dynamic vibration machines;
- Hydraulic vibration machines;
- Piezoelectric vibration machines; and
- Impact exciter.

#### 4.4.2.5.1.2 Types of Excitation

Shock tests are sometimes performed using specified test machines, but more often are performed using more general test machines that can produce transients with a desired shock response spectrum. Although vibration environments may be simulated by mounting the equipment in a prototype system and reproducing the actual environment for the system, it is more common to apply the vibration directly to the equipment mounting points using vibration testing machines [74].

##### 4.4.2.5.1.2.1 *Random Tests*

Random excitations are used to simulate random vibration in those tests where an accurate representation of the environment is desired, specifically, qualification, reliability, and some acceptance tests. The most

commonly used random test machines produce a near-Gaussian vibration. If the actual environment is random but not Gaussian, a Gaussian simulation is acceptable since the response of the equipment exposed to the environment will be near-Gaussian at its resonance frequencies, assuming the equipment response is linear; this is because equipment resonances constitute narrow-band filtering operations that suppress deviations from the Gaussian form in the vibration response of the equipment [74].

#### 4.4.2.5.1.2.2 *Sine Wave Tests*

Sine wave excitations are used to simulate the fixed-frequency periodic vibrations produced by constant-speed rotating machines and reciprocating engines. Sine wave excitations are sometimes superimposed on random excitations for those situations where the service vibration environment involves both. Sine wave excitations fixed sequentially at the resonance frequencies of an equipment item (often referred to as a dwell sine test) are sometimes used in development tests, as well as in durability tests, to evaluate the fatigue resistance of the equipment [74].

#### 4.4.2.5.1.2.3 *Swept Sine Wave Tests*

Sweep sine wave excitations are produced by continuously varying the frequency of a sine wave in a linear or logarithmic manner. Such excitations are used to simulate the vibration environments produced by variable speed rotating machines and reciprocating engines. The usual approach is to make the sweep rate sufficiently slow to allow the equipment being tested to reach a near-full (steady-state) response as the swept sine wave excitation passes through each resonance frequency. Swept sine wave excitations are also used for development tests to identify resonance frequencies and sometimes to estimate frequency response functions [74].

#### 4.4.2.5.1.3 *Types of Transducers*

Certain solid-state materials are electrically responsive to mechanical force; they often are used as the mechanical-to-electrical transduction elements in shock and vibration transducers. Generally exhibiting high elastic stiffness, these materials can be divided into two categories: the self-generating type, in which electric charge is generated as a direct result of applied force; and the passive-circuit type, in which applied force causes a change in the electrical characteristics of the material. A piezoelectric material is one which produces an electric charge proportional to the stress applied to it, within its linear elastic range. Piezoelectric materials are of the self-generating type. A piezoresistive material is one whose electrical resistance depends upon applied force. Piezoresistive materials are of the passive-circuit type. A transducer (sometimes called a pickup or sensor) is a device which converts shock or vibratory motion into an optical, a mechanical, or, most commonly, an electrical signal that is proportional to a parameter of the experienced motion. A transducing element is the part of the transducer that accomplishes the conversion of motion into the signal. A measuring instrument or measuring system converts shock and vibratory motion into an observable form that is directly proportional to a parameter of the experienced motion. It may consist of a transducer with transducing element, signal conditioning equipment, and device for displaying the signal. An instrument contains all of these elements in one package, while a system utilizes separate packages. An accelerometer is a transducer whose output is proportional to the acceleration input. The output of a force gage is proportional to the force input; an impedance gage contains both an accelerometer and a force gage. The types of transducers used in vibration and shock testing can be specified namely as piezoelectric, piezoresistive, optical-electronic, electro-dynamic, servo and capacitance type. The main characteristics of an accelerometer can be written as sensitivity, resolution, transverse sensitivity, amplitude linearity, frequency range, environmental effects and physical properties [74].

#### 4.4.2.5.1.4 *Test Fixtures*

A test fixture is a special structure that allows the test item to be attached to the table of a shock or vibration test machine. Test fixtures are required for almost all shock and vibration tests of equipment because the

mounting hole locations on the equipment and the test machine table do not correspond. For the usual case where the test machine generates recti-linear motion normal to the table surface, a test fixture is also necessary to reorient the equipment relative to the table so that vibratory motion can be delivered along the lateral axes of the equipment, i.e. the axes parallel to the plane of the equipment mounting points. This requires a versatile test fixture between the table and the equipment, or perhaps three different test fixtures. If the direction of gravity is important to the equipment, the test machine must be rotated from vertical to horizontal, or vice-versa, to meet the test conditions. For equipment that is small relative to the test machine table, L-shaped test fixtures with side gussets are commonly used to deliver excitation along the lateral axes of the equipment [74]. Unless designed with great care, such fixtures are likely to have resonances in the test frequency range. In principle, the consequent spectral peaks and valleys due to fixture resonances can be flattened out by electronic equalization of the test machine table motion but this is difficult if the damping of the fixture is low. The best approach is to design the fixture to have, if possible, no resonances in the test frequency range. For equipment that is large relative to the test machine table, excitation along the lateral axes of the equipment is commonly achieved by mounting the equipment on a horizontal plate driven by the test machine rotated into the horizontal plane, where the plate is separated from the flat opposing surface of a massive block by an oil film or hydrostatic oil bearings. The oil film or hydrostatic bearings provide little shearing restraint but give great stiffness normal to the surface, the stiffness being distributed uniformly over the complete horizontal area. Accordingly, a relatively light moving plate can be vibrated that has the properties of the massive rigid block in the direction normal to its plane [74].

#### 4.4.2.5.2 *Acoustic Test*

Acoustic ground tests are performed to determine the ability of the store configuration(s) to withstand and to operate in the flight, ground, and aircraft carrier operations acoustic environments. Internal weapons bays subject stores to intense acoustic fields during periods that bay doors are open. These tests cover weapons bay and external carriage acoustic environments. Acoustic and vibration tests should be combined if possible.

Acoustic tests simulate the higher frequency portions of the aero-acoustically induced vibration environment. The tests verify store operation and structural integrity in this environment. In addition, adequacy of component vibration criteria can be verified.

Low frequency mechanical (shaker) inputs of the vibration test added to the high frequency acoustic energy of the acoustic test provide the best simulation of store flight and ground vibration response.

The test conditions should reproduce the expected service life exposure levels and times. Test conditions are specified as sound pressure spectra at the surface of the test article. For stores with open cavities exposed to airflow the sound pressure within the cavities is also required. The test levels should be determined prior to test. Sources of test levels are listed below in order of preference.

The test article should function in accordance with the specification(s) during and after the test. In addition the test article should not suffer physical or structural damage during the test [5].

#### 4.4.2.5.3 *Hazards of Electro-Magnetic Radiation to Ordnance (HERO) Test*

The electrically initiated munitions and the weapon systems that include such munitions can be affected from the Electro-Magnetic (EM) energy in the environment. HERO tests are designed to measure the level of EM energy which can be induced into ordnance circuits and dissipated Electrically Initiated Devices (EIDs).

Initiation can occur in two ways; the first way causes the EID to be directly affected from the EM energy in the environment. A cable that acts like an antenna end collects the EM energy in the environment can be example to this way. The second way causes the electrical/electronic system that provides electrical current for the inductions system to be affected from the EM energy in the environment.

The tests are structured to reproduce the electro-magnetic environment normally encountered during the sequence from shipping, handling, loading through to delivery. Army conditions are as specified in ADS-37 [75].

Some examples to EIDs are given below:

- Hot bridge-wire;
- Exploding bridge-wire;
- Exploding foil initiator;
- Semiconductor bridge – SCB;
- Semiconductor igniter;
- Conductive mix initiator;
- Carbon bridge; and
- Laser diode initiator.

The test data is analyzed in context with the evaluation criteria to yield a meaningful assessment of the potential effects of the EM energy. These effects are treated as two categories:

- Hazards in which spurious initiation of an EED might result in injury to personnel or damage to material; and
- Reliability degradation in which spurious initiation of an EED might result in dudding or degradation of ordnance.

Adequate design protection for electro-explosive sub-systems and EIDs must be verified to ensure safety and system performance. Unless a theoretical assessment positively indicates that the induced stimulus on EID firing lines or in electronic circuits associated with safety critical functions is low enough to assure an acceptable safety margin in the specified EME, a HERO test will be required [5].

#### 4.4.2.5.4 *EMC/EMI Tests*

Electro-Magnetic Interference (EMI) is an electro-magnetic disturbance which may degrade the performance of an equipment (device, system or sub-system) or causes malfunction of the equipment. Electro-Magnetic Compatibility (EMC) is a near perfect state in which a receptor (device, system or sub-system) functions satisfactorily in common electro-magnetic environment, without introducing intolerable electro-magnetic disturbance to any other devices, equipment or system in that environment.

All kinds of electronic devices, RF receivers, electric motors, fast switching digital devices, integrated circuits, natural thunderbolt, aircraft navigation and military equipment are potential sources of EMI. In addition, all receivers such as communication receivers, medical devices, computers, microprocessors, living beings, industrial controls, analog sensors are also sources of EMI. Hence, types of EMI problems can be categorized as device-level, system-level and inter-system levels.

A system is said to be electro-magnetically compatible if it doesn't cause interference with other system; if it is not susceptible to emissions from other systems and if it doesn't cause interference with itself. The methodologies to prevent EMI are based on suppressing the emissions at source point; making the coupling path as inefficient as possible and making the receiver less susceptible to emission. There are several types of control techniques for electro-magnetic interference, which can be listed as:

- **Grounding:** The reason of grounding is to decrease RF voltages that cause electro-magnetic interference.

- **Shielding:** Shielding is used for isolating a specific area from electro-magnetic medium or for preventing of shedding of inner electro-magnetic medium to outside.
- **Bonding:** Bond is the electrical connection between two conductives. Same level of the reference point of the device at every point is possible by perfect or very low impedance bonding.
- **Filtering:** Filters are used for suppressing conducted interference on power, signal and control lines.

EMC of aircraft is a process of proving the capability of aircraft to operate satisfactorily in EMI environment. It is an involved process wherein considerable efforts towards design and test are required at various hierarchical levels. Effective EMI control on aircraft is possible and can be realized only if EMC exists at firstly the individual functional units and secondly at the system level comprising of several individual functional units. Hence EMI/EMC testing for aircraft is usually done in two phases:

- At sub-system level; and
- At system level, where all the sub-systems are integrated together.

The cause of EMI in aircraft are many current carrying wires and cables, electro-mechanical components like relays, etc., other switching circuits in unit, oscillators, radio frequency and high-power transmitters, lightning, high-tension power lines, electro-static discharge etc. Also extra-terrestrial sources like sun, cosmic effects, radio, stars, etc., are also considered causes of EMI. Therefore present day aircraft structures use composite and Glass Fiber Reinforced Plastics (GFRP) materials for lightweight advantage thereby increasing the potential EMI hazards due to their lower Shielding Effectiveness (SE) as compared to metals.

One of the worst EMI problems in the world has been occurred on 29th of July 1967 at US Aircraft Carrier “Forrestal”. A4 “Skyhawks” on the deck were loaded with two 1000 lb. bombs, air-to-ground and air-to-air missiles. Somewhere on the deck of that carrier, attached to the wing of an aircraft, was an improperly mounted shielded connector. As the Radar swept around, RF voltages generated on that cable ignited a missile which streaked across the deck, striking an aircraft and blowing its fuel tanks apart. Its two 1000 lb. bombs rolled to the deck and exploded. Wing-tip to wing-tip, the planes burned and the bombs exploded. Fire spread below deck, and before it was extinguished, 134 people were dead or missing.

The military aircraft contains various electro-magnetic signal transmitters, power systems and control electronics. Figure 4-34 shows various transmitters and Electronic Warfare (EW) antenna of aircraft.

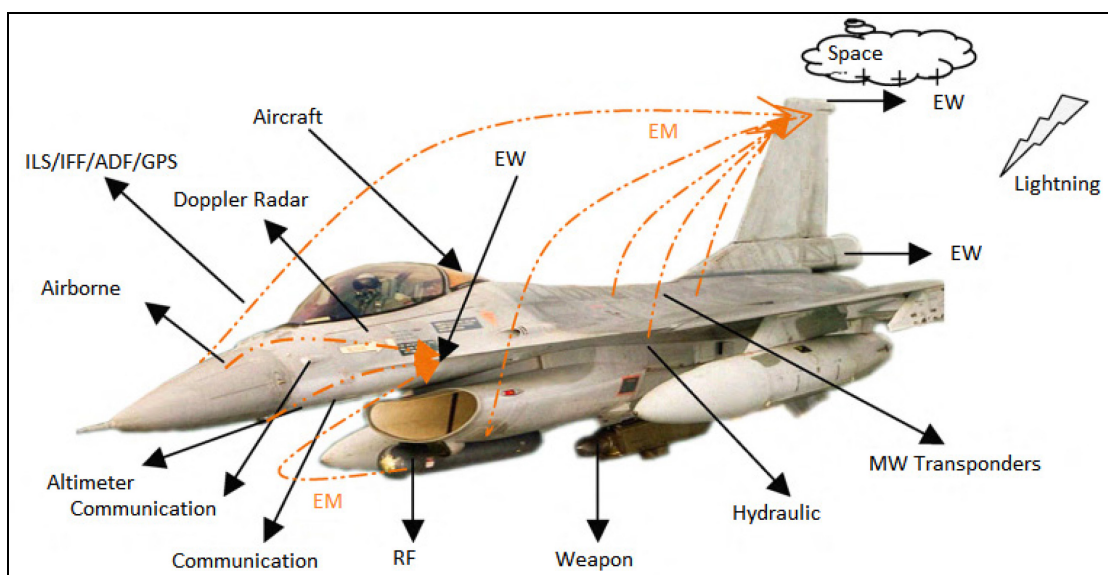

**Figure 4-34: Various Transmitter and EW Antenna of A/C.**



The transmitters used in military aircraft can generate high voltage, short duration spikes. The atmospheric disturbances like Electro-Magnetic Pulse (EMP) due to lightening and electro-magnetic charge in space can also generate surges. The resulting electric and magnetic fields may couple with electrical/electronic systems to produce damaging current and voltage surges. The spikes can propagate through space and along the harnesses causing electro-magnetic interference or coupling to the systems in the aircraft.

In conclusion, EMI/EMC for aircraft is a major issue that is being addressed since World War days. Due to the changes in EMI scenario over the past two decades, several control techniques have been evolved to counter EMI. It is very important for the aircraft systems to function in both hostile and non-hostile EMI environment, as this would ensure the mission effectiveness. Towards this, a considerable effort in design is necessary right from the conception and development stage of the aircraft. There is a need to regularly monitor and update oneself with the current technologies in order to effectively design and test aircraft equipment. A preventive maintenance program should form part of proactive EMC control program to maintain the existing and ageing aircraft EMI protection techniques.

On the other hand, EMI/EMC testing plays a key role in certification process. This is one of the longest and problematic test process in certification.

One can summarize EMI/EMC test in four main branches:

- Conducted emission;
- Conducted susceptibility;
- Radiated emission; and
- Radiated susceptibility.

As easily understood from name, these test figures out interaction between aircraft and store, in wireless and wired way.

Conducted or wired interactions are on power lines, cable injections, antenna input inter modulation and cross modulation. In these tests, both parties observed for any malfunction or reduction in performance.

For radiated interactions, magnetic field, electrical field, transient electro-magnetic field are applied and measured. Susceptibility on antennas and other critical devices of store and aircraft systems are carefully observed. Also emissions on all frequencies due to antennas (harmonics) and power and data lines (disturbance) are observed.

For all the test families, there are two main standards. MIL-STD-461F [76] is mainly applied for device-level tests and MIL-STD-464C [77] is mainly applied at system that is mentioned for whole aircraft in the standard.

The tests are applied according to the MIL-STD-461F that specifies detailed emissions and susceptibility requirements and the associated test procedures. Table 4-2, which is taken from the standard, is a list of the specific requirements established by this standard identified by requirement number and title. General test procedures are included in this document.

**Table 4-2: Emission and Susceptibility Requirements.**

REQUIREMENT	DESCRIPTION
CE101	Conducted Emissions, Power Leads, 30 Hz to 10 kHz
CE102	Conducted Emissions, Power Leads, 10 kHz to 10 MHz
CE106	Conducted Emissions, Antenna Terminal, 10 kHz to 40 GHz
CS101	Conducted Susceptibility, Power Leads, 30 Hz to 150 kHz
CS103	Conducted Susceptibility, Antenna Port, Intermodulation, 15 kHz to 10 GHz
CS104	Conducted Susceptibility, Antenna Port, Rejection of Undesired Signals, 30 Hz to 20 GHz
CS105	Conducted Susceptibility, Antenna Port, Cross-Modulation, 30 Hz to 20 GHz
CS109	Conducted Susceptibility, Structure Current, 60 Hz to 100 kHz
CS114	Conducted Susceptibility, Bulk Cable Injection, 10 kHz to 200 MHz
CS115	Conducted Susceptibility, Bulk Cable Injection, Impulse Excitation
CS116	Conducted Susceptibility, Damped Sinusoidal Transients, Cables and Power Leads, 10 kHz to 100 MHz
RE101	Radiated Emissions, Magnetic Field, 30 Hz to 100 kHz
RE102	Radiated Emissions, Electric Field, 10 kHz to 18 GHz
RE103	Radiated Emissions, Antenna Spurious and Harmonic Outputs, 10 kHz to 40 GHz
RS101	Radiated Susceptibility, Magnetic Field, 30 Hz to 100 kHz
RS103	Radiated Susceptibility, Electric Field, 2 MHz to 40 GHz
RS105	Radiated Susceptibility, Transient Electro-Magnetic Field

Highlighted line in Table 4-3, which is also taken from this standard, summarizes the requirements for equipment and sub-systems intended to be installed in, on, or launched from military aircraft. When an equipment or sub-system is to be installed in more than one type of aircraft, it shall comply with the most stringent of the applicable requirements and limits. An “A” entry in the table means the requirement is applicable. An “L” entry means the applicability of the requirement is limited as specified in the appropriate requirement paragraphs of this standard; the limits are contained herein. An “S” entry means the procuring activity must specify the applicability, limit, and verification procedures in the procurement specification.



Table 4-3: Requirement Matrix.

Equipment and Sub-Systems Installed in, on, or Launched from the Following Platforms or Installations	Requirement Applicability																
	CE101	CE102	CE106	CS101	CS103	CS104	CS105	CS109	CS114	CS115	CS116	RE101	RE102	RE103	RS101	RS103	RS105
Surface Ships		A	L	A	S	S	S		A	L	A	A	A	L	A	A	L
Submarines	A	A	L	A	S	S	S	L	A	L	A	A	A	L	A	A	L
Aircraft, Army, including Flight Line			L	A	S	S	S		A	A	A	A	A	L	A	A	L
Aircraft, Navy			L	A	S	S	S		A	A	A	L	A	L	L	A	L
Aircraft, Air Force			L	A	S	S	S		A	A	A		A	L		A	
Space Systems, including Launch Vehicles			L	A	S	S	S		A	A	A		A	L		A	
Ground, Army			L	A	S	S	S		A	A	A		A	L		A	
Ground, Navy			L	A	S	S	S		A	A	A		A	L		A	L
Ground, Air Force			L	A	S	S	S		A	A	A		A	L		A	
Legend:																	
A: Applicable																	
L: Limited as specified in the individual sections of this standard																	
S: Procuring activity must specify in procurement documentation																	

MIL-STD-464C is about Electro-Magnetic Environmental Effects (E3) requirements for aircrafts. E3 are the impact of the Electro-Magnetic Environment (EME) upon the operational capability of military forces, equipment, systems and platforms. E3 encompasses the electro-magnetic effects addressed by the disciplines of Electro-Magnetic Compatibility (EMC), Electro-Magnetic Interference (EMI), Electro-Magnetic Vulnerability (EMV), Electro-Magnetic Pulse (EMP), Electronic Protection (EP), Electro-Static Discharge (ESD), and Hazards of Electro-magnetic Radiation to Personnel (HERP), Ordnance (HERO), and volatile materials (HERF). E3 includes the electro-magnetic effects generated by all EME contributors including radio frequency (RF) systems, ultra-wideband devices, High-Power Microwave (HPM) systems, lightning, precipitation static, etc. MIL-STD-464C establishes E3 interface requirements and verification criteria for aircraft including associated ordnance.

Table 4-4, which is taken from MIL-STD-464C identifies what kind of EMI/EMC testing is required when new, modified, or carry-on equipment will be used on military aircraft. The tests and analyses are used the methodology in MIL-HDBK-240 [78] for HERO. Interaction matrix is established by related integration team members for interoperability test (source-victim testing) due to integration program.

Table 4-4: Type of EMI/EMC Testing.

Type of electrical/electronic equipment to be installed on aircraft	Is EMI laboratory testing required? (Yes/No and Type)	Is EMC aircraft-level testing required? (Yes/No and Type)
1) New or permanently changed/modified equipment	Yes E and S	Yes R, O, G
2) Temporary equipment with no antenna transmissions meant to be used only for a fixed period of time	Yes Flight Critical – E and S Non-Flight critical – E	Lab compliant – No Non-compliant* – Yes – R
3) Temporary equipment using antenna transmissions meant to be used only for a fixed period of time	Yes Flight Critical – E and S Non-Flight critical – E	Lab compliant – Yes – R, G Non-compliant* – Yes – R, O, G
4) Carry-on equipment with no antenna transmissions	Yes Flight Critical – E and S Non-Flight critical – E	Lab compliant – No Non-compliant* – Yes – R
5) Carry-on equipment using antenna transmissions	Yes Flight Critical – E and S Non-Flight critical – E	Lab compliant – Yes – R Non-compliant* – Yes – R, O, G
6) Electrically initiated devices (EID)	Yes H	Yes H, G
<p>* Analysis is required to assess whether equipment that does not comply with MIL-STD-461 needs special attention at the aircraft level. Non-compliance is not intended to indicate that failure to meet contractual requirements is acceptable. Commercial-off-the-shelf equipment being considered for use that was not designed to meet MIL-STD-461 will often have some outages with respect to the standard that may or may not be of concern.</p> <p>Types of tests:</p> <p><b>E</b> – Radiated and conducted emissions (Tests: RE102, CE102 only if connected to A/C power, CE106 only if it has antenna ports).</p> <p><b>S</b> – Radiated and conducted susceptibility (Tests: RS103, CS101, CS114, CS115, CS116).</p> <p><b>H</b> – Hazard of Electro-magnetic Radiation to Ordnance (HERO) component testing. EED/EID should be instrumented and show 16.5 dB safety margin from the determined no-fire current.</p> <p><b>R</b> – Intentional, harmonic, and spurious emissions must be evaluated for interference in the band-pass of aircraft antenna connected RF receivers via spectrum analyzer scans or other similar technique.</p> <p><b>O</b> – Non-compliant emissions may require an evaluation of the band-pass of aircraft antenna connected RF receivers via spectrum analyzer scans or other similar technique.</p> <p><b>G</b> – Source-victim testing.</p>		

Although it is related to the dimensions of the store and aircraft, these tests may take 2 – 4 months. Conducted and radiated emission tests are mostly problematic tests especially high voltage levels and high data rates.

### 4.4.3 Flight Tests

#### 4.4.3.1 Flight Test Instrumentation and Planning

##### 4.4.3.1.1 Flight Test Instrumentation Design and Implementation

Since aircrafts are getting more complex year by year, the need for adequate detailed analyses which is made using the objective test data, instead of test pilot's subjective judgment has been increased. The objective test data can be collected during flight with some special equipment.

In general terms, flight test instrumentation is denoting the aircraft, helicopter, rocket, Unmanned Air Vehicle (UAV) any flying platform, missile, pod, fuel tank or any stores, with test equipment for test purposes. Flight test instrumentation is made to collect the data that the system engineers required, record the collected data on-board, transmit the collected data to the ground station if needed and have the data in ground station in a form suitable for evaluation. The test equipment consist of data acquisition systems, data recording systems, transmitters, transmitting antennas, sensors, transducers, cameras, high-speed cameras, control units, etc.

Using these equipment the data from the main data transmission line of the aircraft (Mux Bus), force, vibration, pressure, frequency, temperature information from desired units parts or locations, voltages and currents of any systems and sub-systems can be collected, and recorded on board.

All the data that recorded on-board can be transmitted simultaneously via telemetry systems to the data processing sub-systems. At the same time all the data can be observed, analyzed and evaluated by the system engineers at the ground station.

The instrumentation will provide:

- Feedback to the product designers which they need to evaluate the validity of the design;
- Basis for design alterations;
- Information to evaluate if the product is in accordance with design specifications or not; and
- Insight about how well the system will work operationally once fielded [79].

Instrumented flying platforms or stores can be used for purposes:

- To certify a flying platform;
- To certify an external store;
- To make store separation tests/qualifications of the bomb, rocket, adapter, pod, fuel tank, etc.;
- To make the certification of avionics and structural upgrade activities;
- To determine the cause of the intermittent failures which occur only in flight of the air vehicle or its sub-systems;
- To verify the operational flight programs;
- To collect the data from the aircraft engine and/or structure for durability and damage tolerance analysis;
- To determine the effects on the repairable items and related mean-time between failures; and
- To follow the performance of the flight crew.

#### 4.4.3.1.2 Phases of Flight Test Instrumentation Process

Flight test instrumentation process can be classified in four main sub-processes. These sub-processes are:

- Pre-instrumentation phase;
- Design phase;
- Production and implementation phase; and
- Test and calibration phase.

#### 4.4.3.1.3 Pre-Instrumentation Phase

Pre-instrumentation phase consists of:

- **Definition of Parameters:** Parameters which are going to be collected should be defined clearly by system engineers who are going to evaluate the collected parameters. The parameters should be listed in a document and this document should be provided to the flight test instrumentation engineers. Name of the parameter, unit of the parameter, measurement locations, sampling rates and the needed accuracy of the measurement should be defined clearly. If the parameter is going to be taken from the Mux Bus the message block and the address of the parameter should also be defined. The need for real-time data transmission should be specified as well. The parameter list can be given as an appendix of flight test plan.
- **Pre-Design Examination:** The flying platform which is going to be used in flight tests must be examined before determining the flight test instrumentation equipment needed. Especially in military jets, finding empty space to locate the flight test instrumentation equipment may be a problem. The draft locations of big equipment such as data acquisition systems, data recorders, transmitters and control units should be specified. Some units may be removed so that empty spaces for the flight test equipment can be generated. For example, if flight tests are planned for certification of external stores radar warning receiver systems can be removed from the aircraft, or if the tests are going to be conducted in daylight, the control units of night vision can be removed.

#### 4.4.3.1.4 Design Phase

After having the detailed parameter list and pre-design examination design process starts. An efficient flight tests Instrumentation design should answer the questions below:

- What should be the data transmission technique?
- Is real-time data processing being needed? For example in flight flutter testing real-time data processing is crucial. In flight flutter tests the air vehicle is instrumented with exciters, accelerometers and transmitters to send the test data simultaneously to the ground station to be analyzed. Since flutter is a very severe instability, which develops suddenly, the data should be followed carefully by the engineers at the ground station and feedback should be provided to the pilot urgently when needed.
- Can an existing system be used or a new design is required for on-board instrumentation?
- Should an exclusive digital system be used or included analog techniques are sufficient?

After answering these questions flight test instrumentation equipment needed should be determined. After having the detailed parameter definitions the appropriate flight test instrumentation equipment which are going to be used are determined. Data Acquisition systems, sensors and transducers which fulfills the sampling rate and measurement accuracy requirements should be chosen. The dimensions of the equipment are also crucial. Equipment chosen should fit into the empty spaces specified or generated.

The exact locations of data acquisition systems, data recording systems, transmitters, transmitting antennas, sensors, transducers, cameras, high-speed cameras and control units should be specified. In Figure 4-35, the locations of accelerometers are given for an aircraft which is instrumented for flight flutter tests.

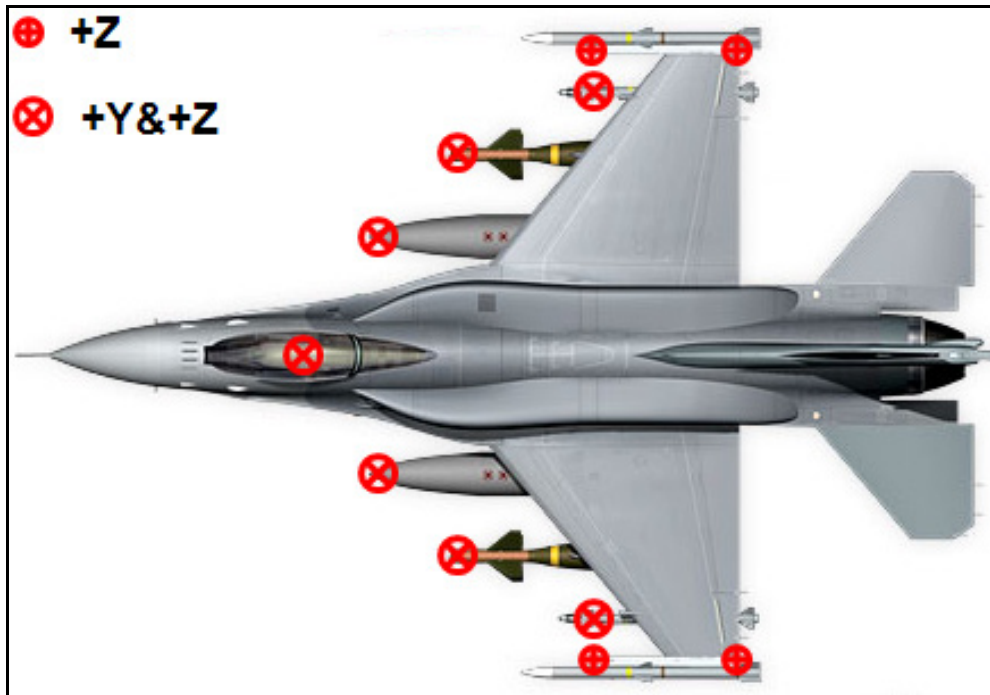

Figure 4-35: Locations of Accelerometers.

Flight tests, where safe separation is evaluated, are the most critical stage for a new expandable external store certification. Understanding of how a store reacts when released from a flying platform provides engineers, the ability to identify the safety issues which may cause risks for the aircraft and the pilot. Moreover, understanding how a released store reacts also provides the knowledge required to develop accurate and safer systems.

One of the methods to verify the store-vehicle compatibility is recording of separation using on-board high-speed video cameras. It is important to choose proper air-borne high-speed cameras which may overcome high g loads and high vibrations. Generally high-speed cameras have random memories, and permanent memories. Once powered up the camera begin to record images and store them in a circular buffer to internal random memory. To store the recorded images permanently in cameras internal memory or any other storage, high-speed camera needs to be triggered. This mechanism allows the user to store the images recorded a specified time before triggering, to the random memory. The time gap should be designated so that the stored film covers the whole separation process. Connections of the high-speed cameras should be made depending on test requirements. Arranging the proper connections, high-speed cameras can be triggered by jettison or release signals generated by the aircraft/flying platform.

Stamping time data on the recorded images is also important to match the images and other flight test data on a common time base in means of post-flight analyses. IRIG-B may be used as a common time reference, if available. The high-speed camera should synchronize each frame to this reference time.

High-speed camera locations should be chosen where the separation can be observed clearly. To provide the clear line of sight, high-speed cameras can be located in other external stores, in the fuselage, under the wing or fuselage in direct free air stream.

To carry the high-speed cameras in other external loads, the external load should be modified, or a new external load should be produced which is dimensionally and inertially an exact copy of a certified load. In Figure 4-36 camera pod used in F-16 separation tests is shown.

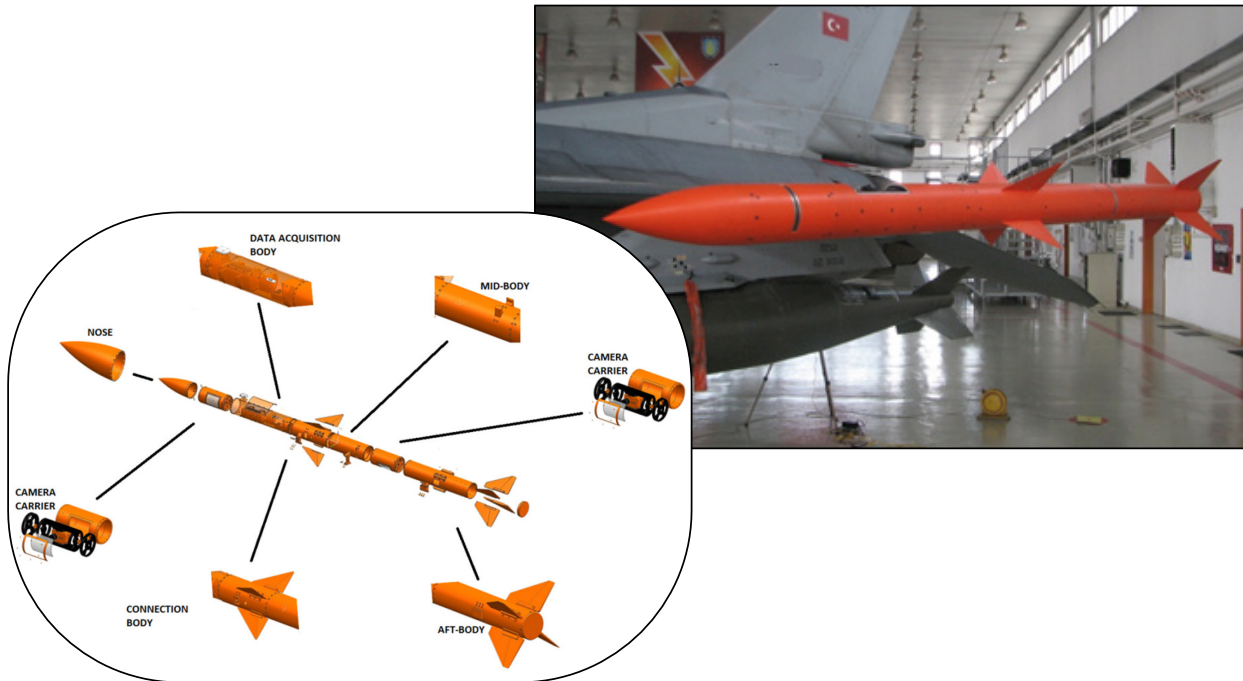

Figure 4-36: Camera Pod Used on F-16.

To carry high-speed cameras under the wing or fuselage in direct free air stream, an adaptor should be designed considering fluid dynamic analysis, manufactured and installed on the flying platform. The adaptor can either be installed on present store carrying stations, or installed on a modified part of the flying platform. The camera adaptor used on F-4 aircraft and its applications, the camera adaptor used under the fuselage of F-16 aircraft and its applications, and the high-speed camera used inside the fuselage of F-16 aircraft are shown in Figure 4-37, Figure 4-38 and Figure 4-39, respectively.



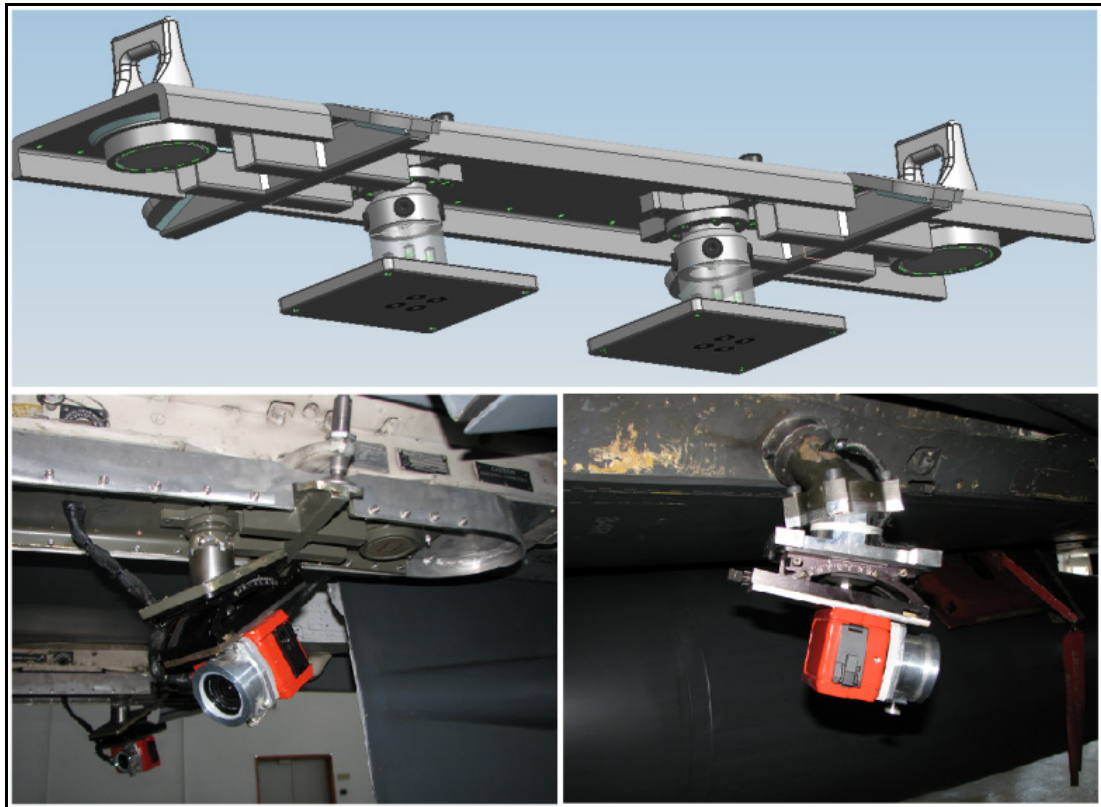

Figure 4-37: Frontal Camera Adaptor, its Application and Rear Camera Adaptor on F-4.

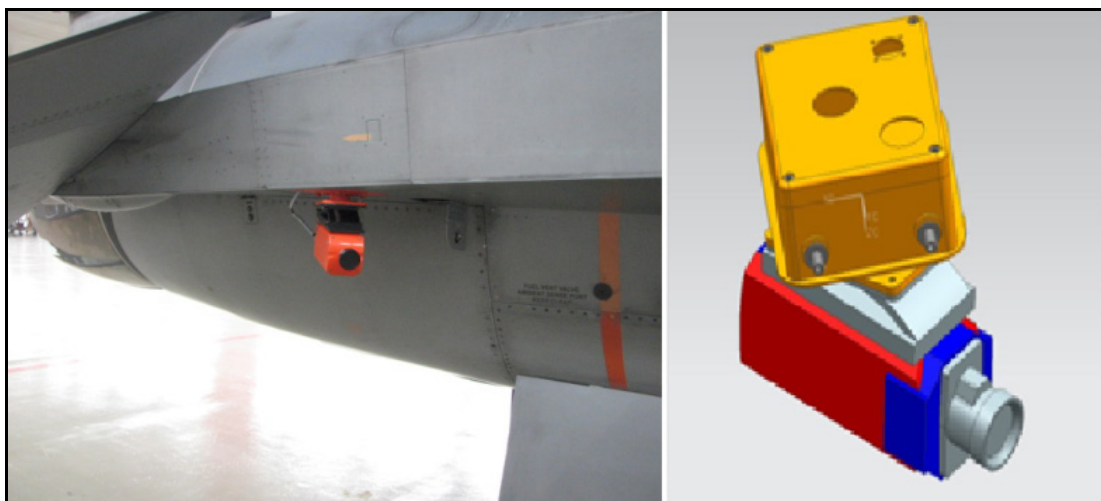
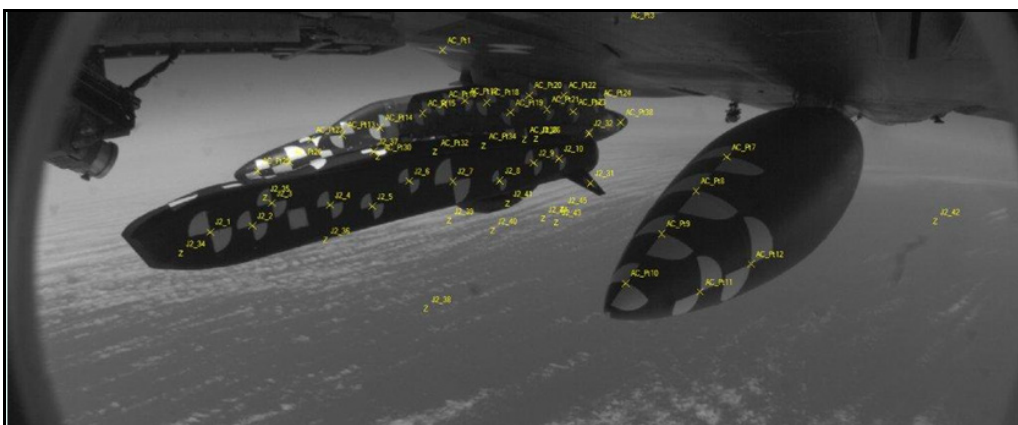

Figure 4-38: Rear Camera Adaptor and its Application Under the Fuselage of F-16.



**Figure 4-39: Camera Application Inside the Fuselage of F-16.**

Expandable store and the background (drop-tanks, wing, fuselage, etc.) should be marked remarkably so that the movement of the marked points on the store can be observed with respect to the background by the software that is used for post-process analysis of the images recorded. The remarks on the cruise missile and the background are shown in Figure 4-40.



**Figure 4-40: Picture Taken from a High-Speed Camera.**

Light condition is a big challenge in high-speed camera recording. Under the wing tip the store may be in shadows and after the release it may be in bright sunlight, after the release there may also be a variety of backgrounds as cloud white, sea blue, forest green, snow white, etc. The camera system chosen should overcome this lighting and contrast diversity.

The safe separation trajectory is identified by post-flight processing of the images recorded by high-speed cameras using photogrammetric methods. After the methodology for photogrammetric safe separation analysis is determined and the analyses are performed, then the analysis results are compared to the results of computational fluid dynamic analysis to observe consistency [80].

Photogrammetry is a technique used to extract reliable measurements from video and/or film of the objects and the environment. A photogrammetric solution consists of a 6-DOF time history, from which velocities and rates can be computed. An important quantity that is derived from the 6-DOF time history is the miss distance, which is a time history of the closest point of approach between the surface of the moving store and the surface of another object, such as the aircraft's fuselage or a fuel tank.

The need for mechanical or electronic interfaces must be determined. The interfaces should be designed. In Figure 4-41 a mechanical interface designed to implement the IRIG time generator and a network switch which is used for data acquisition is given.

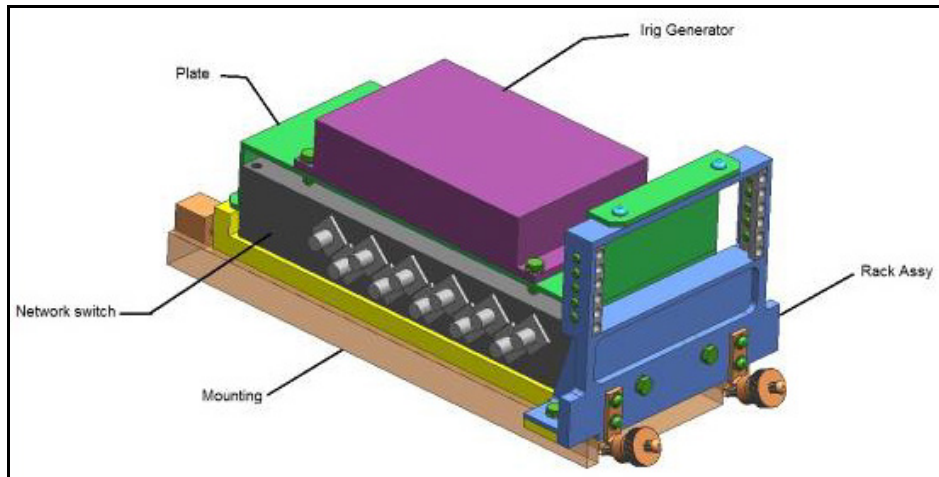

**Figure 4-41: Mechanical Interface Designed for Implementation of FTI.**

The wiring diagrams between the equipment and the units should be drawn. Lengths and types of the cables must be specified and the cable bundles should be designed. Cable routings must be specified.

#### 4.4.3.1.5 Production and Implementation Phase

After designing the instrumentation system, mechanical and electrical interfaces and the cable bundles, interfaces and cables are produced. In Figure 4-42, a mechanical interface designed for mounting an accelerometer in F-16 370 gallon external fuel tank for flight flutter tests can be seen.

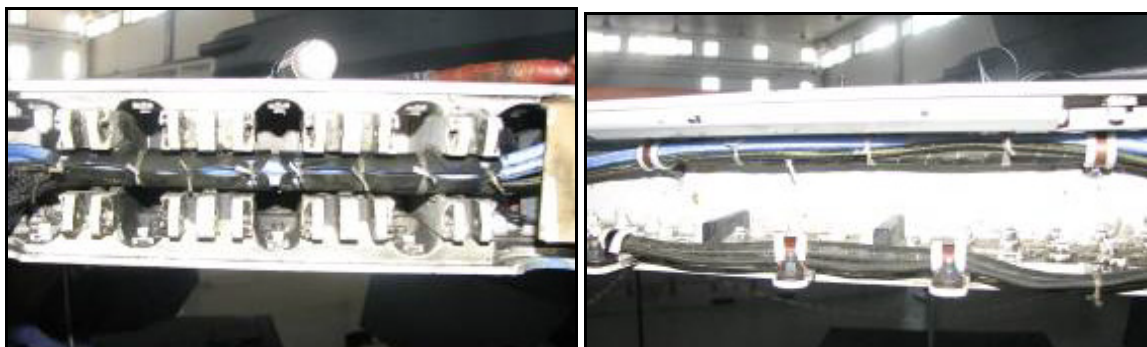

**Figure 4-42: A Mechanical Interface for the Accelerometer Used in F-16 External Fuel Tanks.**

The produced interfaces, cables, data acquisition systems, data recording systems, transmitters, transmitting antennas, sensors, transducers, cameras, high-speed cameras, and control units are implemented in test platform afterwards. Data acquisition system and other flight test equipment which are implemented in electronic compartment of F-16 aircraft, the flight tests cable bundles in wing leading edges and the camera interfaces to watch the wing tips are shown in Figure 4-43, Figure 4-44 and Figure 4-45, respectively.

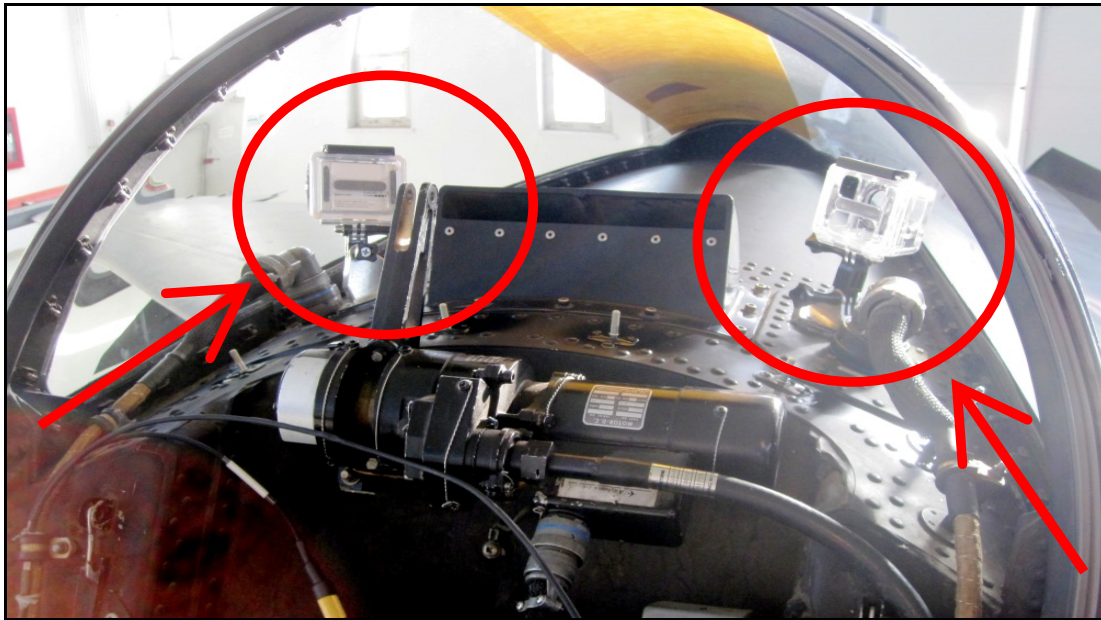

**Figure 4-43: Flight Test Instrumentation Equipment in F-16's Electronic Compartment.**



**Figure 4-44: Flight Test Instrumentation Cabling on F-16 Wings.**





**Figure 4-45: Camera Interfaces in the Cockpit of F-16.**

#### 4.4.3.1.6 Test and Calibration Phase

After implementing the flight test instrumentation system on the test platforms, the system should be calibrated and the functionality tests of the instrumentation system should be performed. If needed some flight test instrumentation calibration flights may be conducted.

#### 4.4.3.1.7 Flight Testing and Sortie Planning/Execution

Flight testing develops and gathers data during flight and then analyzes the data to evaluate the flight characteristics of the air vehicle and validate its design including safety aspects. By flight testing two major tasks are accomplished:

- Gathering data for design and then; and
- Verifying and documenting the air vehicle capabilities for certification or customer acceptance.

Flight testing is a highly expensive and potentially risky task. Unforeseen problems can lead to damage to air vehicle or store body and loss of life of pilot or people on the ground. Thereby, flight testing and sortie planning are the most safety conscious part of the design stage.

For military aircraft, flight test preparation begins well before the aircraft is ready to fly. Before sortie planning, what needs to be tested must be well defined.

Each sortie in a test program requires careful planning to ensure that the flight follows a safe progression and that the maximum amount of high-quality data is gathered in flight time available. Where possible tests are conducted concurrently, for example, information on flight control positions and engine bay temperatures can be gathered during level flight performance tests. This clearly requires careful liaison between the different parts of a flight test organization if they are all involved in the same trial. The individual test points are organized such that successive points can be achieved quickly. The principle is that no flight time is wasted. It is better to have too many test points in a sortie plan than too few but the plan still needs to be reasonable and achievable. The possible effects of weather are considered as well so that tests are organized into high level and low sorties to ensure that time is not wasted if visual meteorological conditions (wms) is

not appropriate for flight. For each sortie the ‘go / no go’ criterion is decided upon at the planning stage, for example this might be a minimum light level or a maximum wind strength.

Another part of the sortie planning procedure is to produce a written flight brief, which will be used during the pre-flight briefing to ensure that all trials participants are fully prepared. Included in this brief will be the flight safety points, priorities, limitations, ‘go / no go’ criteria, possible alternate tests, criteria for stopping the tests, and responsibilities.

Test execution is defined as following pre-defined procedure of flight test (pre-flight controls, maneuvers, etc.) and gathering data (pictures, videos, meteorological data as well as data gathering during flight) during testing. After the testing, aircraft must be examined and the data gathered must be processed, analyzed to decide if the test was successful or not. According the decision made, the test will either accepted or repeated.

#### *4.4.3.1.8 Overview of Flight Test Team Responsibilities*

Ideally the flight test organization should be an independent and a composite test team which is tasked impartially evaluating and reporting on the aircraft or system. The test team should put aside all particular interests and focus on the common goal. Members of the test team would include flight test engineers, aircrew, and analysts (sometimes from contractor). In addition to flight test engineers who have responsible of ensuring compliance with the top-level specifications and statement of objectives, the test team may include the design engineers who provide the technical expertise. Instrumentation personal also provide a key role on the test team, ensuring that data are available in a format that is usable. The personnel within the organization should be knowledgeable of the system under test. They should understand the basic operation of the system, the interfaces with other avionics systems aboard the aircraft, and where and how the system will be employed.

The most important goal of the flight test team are to validate that the aircraft/system being tested meets the requirements and be fair and accurate reporting of all tests conducted and the results obtained. This is accomplished by ensuring the top-level specifications are satisfied and by performing some measure of system performance testing.

The flight crew is an integral part of the flight test team. They are the operational expertise of the joint test team, are qualified in the aircraft with some recent fleet experience, graduates from the Test Pilot School (TPS), and should be knowledgeable of the system under test.

Ideally the flight crew is assigned at the beginning of the program so they can follow the development of system, become expert in the weapon’s integration, and support this testing concept experience as an input.

The test pilot is the safety of flight co-ordinator on the test team who identifies unsafe flight tests and is the key in anomaly tracking and resolution. They are the link to the telemetry control room during the flight tests, and are a member of the test planning group and one of the main liaisons with design engineering and software development.

**Test Pilot:** A test pilot is a pilot who undertakes the testing of an aircraft, its parts or associated systems within the bounds of a specific approval granted for that purpose. A test pilot may conduct flight testing of an aircraft, its parts or associated systems for one or more of the following purposes:

- To establish or expand the flight envelope;
- To establish whether the handling qualities, performance, flight characteristics, systems, displays and human factors associated with the aircraft are safe and comply with the regulatory and certification requirements;
- To establish whether the handling qualities, performance, flight characteristics, systems, displays and human factors associated with the aircraft are fit for purpose;



- To provide data and observations in support of experimental or development programs;
- To assess novel, unusual systems, displays or procedures;
- To establish new piloting techniques; and
- To display, demonstrate and provide flight training on certified and non-type certified aircraft.

In addition, a test pilot may be required (with or without other personnel) to provide:

- Flight safety and risk assessment advice including the determination of higher risk activities;
- Flight test program and scheduling advice, instrumentation requirements, advice of flight test profiles planning and special test requirements;
- Advice as necessary on flight manual, operational and environmental; [noise, public nuisance, weather] matters; and
- Verbal and written debriefs as necessary.

The flight brief should be broken down into two briefings:

- **Technical Team Brief:** It is held minimum 24 hours prior to the flight. Flight (Run) cards are reviewed for correctness and the flight is analyzed with respect to program goals, and previous flight's results are discussed. The meeting is concluded only after all technical discussions have been resolved and the test run cards have been rewritten to every participant satisfaction. The test run cards will be highlighted for any special actions required by the any test team member. Test run cards must be firm at the conclusion of the brief, and approved by the authority.
- **Flight Brief:** It is normally held two hours prior to the test flight. Aircrew, test conductor, aircraft co-ordinator and test team must attend the flight briefing. At the beginning of the brief, the aircraft co-ordinator provides an information of the latest configuration and status of the test plane, including:
  - Test plane configuration, both hardware and software;
  - Limitations and flight operating limitations;
  - Special requirements; and
  - Radio frequencies.

After the aircraft co-ordinator brief, the aircrew is talked about some standard mission items. These include the weather forecast, flight time, take-off time and the emergency conditions. An emergency condition is a hypothetical problem with the airplane, and the aircrew is polled to see what they would do.

Debriefs should be held as soon as possible after landing, even if there is more than one flight, because problems and anomalies are easily forgotten over a period of time. The test conductor reviews the test flight as seen by the control room. Time slices for post-flight processing should be determined. The debrief should conclude with a discussion of overall flight results, success rate, and probable goals for the next flight.

The test conductor is responsible for the flight brief and briefing the specific test mission. They must talk about flight cards, objectives, test points, instrumentation, operations, set-up and debrief time. The test conductor is also responsible for the entire test operation. With the exception of air traffic and test range control, the test conductor should be the only voice on the radio.

**Flight Test Engineer:** A flight test engineer is an individual who is responsible for the technical management and/or co-ordination of a flight test program [or part thereof], including the active participation in the airborne task. A flight test engineer may be responsible for any or a combination of the following activities:

- Preparation of the flight test program, provision of advice;
- Co-ordination and specification of instrumentation and/or telemetry requirements and recording needs;
- Drafting the flight test instruction/order;
- Participation in the test flight, provision of airborne advice; and
- Participation in the debrief process including the drafting of reports and retrieval of instrumentation and telemetry data.

In addition, a flight test engineer may be required [with or without other personnel] to provide:

- Flight safety and risk assessment advice including the determination of higher risk activities;
- Flight test program and scheduling advice, instrumentation requirements, advice on flight test profile planning and special test requirements;
- Advice centered on the flight test process including liaison with design personnel on development matters, modifications and changes, and with airworthiness authorities in relation to the certification process; and
- Verbal and written debriefs as necessary.

The aircrew is responsible for concluding the briefing with aircrew co-ordination items, a chase or target brief, if required en route and recovery, and joker and bingo fuel.

In the control room analysts should have assigned seating. All analysts should have Access to Hot Mike, UHF/VHF, and separate integrated communication system networks; however, access to radio should be restricted to those with safety of flight responsibilities.

Overflow should be in a viewing room. The spectators can view test operation, see and hear everything that is going on, but cannot intrude on the test team.

#### **4.4.3.2 Flutter Tests**

Flutter is an aeroelastic phenomenon in which aerodynamic, elastic and inertia forces couple unfavorably at a sufficiently high speed to produce an unstable oscillation which may grow without limit and so result in a structural failure. Flutter is, unfortunately, not a problem that will just “go away”: modern aircraft, in particular, are progressively more flexible, fly faster, and are highly control configured, more maneuverable and more system dependent. The development of active control systems for flutter suppression will actually complicate the problem by introducing a fourth “servo” dimension into the aeroelastic scene and will at best only defer flutter to higher speeds.

For military aircrafts which are to be equipped with a large variety of external stores, the study of the flutter problem will often extend well beyond the first stage of flight testing. This is caused by the fact that variations in the external loading of an aircraft, due to new requirements, may change its flutter characteristics appreciably and by the fact that “intermediate” configurations (after release of stores and with fuel tank partial loadings or fuel transfer failures) must also be considered.

Flutter was recognized as a problem even in the early days of flying and although considerable effort has been made towards the understanding of the problem, flutter still remains a major consideration when designing new aircraft. This is due in part to the fact that newer construction materials and more sophisticated construction techniques have led to an ever-decreasing relative thickness of the aircraft’s lifting surfaces. The stiffness of these structures has, however, hardly increased and, therefore the sensitivity to flutter has increased accordingly. On the other hand flying speeds have also increased considerably from subsonic to

transonic and supersonic speeds and, as a consequence, the aerodynamic loads related to flutter have not only grown, but have also changed their character due to encountering shock waves.

Flight flutter tests are conducted to demonstrate freedom from flutter for critical aircraft conditions. Flight flutter testing on an instrumented F-16 A/C is shown in Figure 4-46. The stability results derived from those tests are used to validate the flutter analysis. Both test results and calculated results are used to demonstrate compliance with the airworthiness requirements. Active control systems (ride control, gust load alleviation, flutter suppression, etc.) add to the scope and complexity of these tests in that control system instability due to aeroelastic interactions must also be considered. Wind tunnel tests usually form part of the validation process and flutter in this environment can result in costly damage or loss to the wind tunnel.



**Figure 4-46: Flight Flutter Test on F-16 A/C for Newly Developed Munitions.**

Reliable flight and wind tunnel test procedures are therefore required to minimize the hazard of these tests. This requires that effective methods be used for exciting the aircraft or model and those reliable, on-line and off-line methods to be used for estimating the stability from the measured structural and control system responses (parameter estimation). In addition, effective procedures for preventing damage must be available in the event that instability is experienced. In some instances this has led to the use of active flutter suppression systems on wind tunnel models.

The principal impediments to achieving reliable estimates for stability parameters are the short test time on condition and the high noise levels in the data collected. A number of methods have been developed or are being proposed to address these problems and will be discussed below.

Non-linear aerodynamics, structural dynamic, or control system characteristics provide further impediments to reliable stability parameter estimates because a larger data base is required to identify and characterize the non-linear behavior and because estimation methods generally used assume linear processes. It is therefore important to determine what parameter estimation methods have been used and how successful those methods have been particularly in the presence of non-linear conditions [53].

Analyses, wind tunnel and laboratory tests, and aircraft ground and flight tests shall demonstrate that flutter, divergence, and other related aeroelastic or aeroservoelastic instability boundaries occur outside the 1.15 times design limit speed envelope. The aircraft shall meet the following stability design requirements for both normal and emergency conditions [53]:

- Flutter Margin:** Fifteen percent equivalent airspeed margin on the applicable design limit speed envelope, both at constant altitude and constant Mach number as indicated in Figure 4-47 obtained from [81].

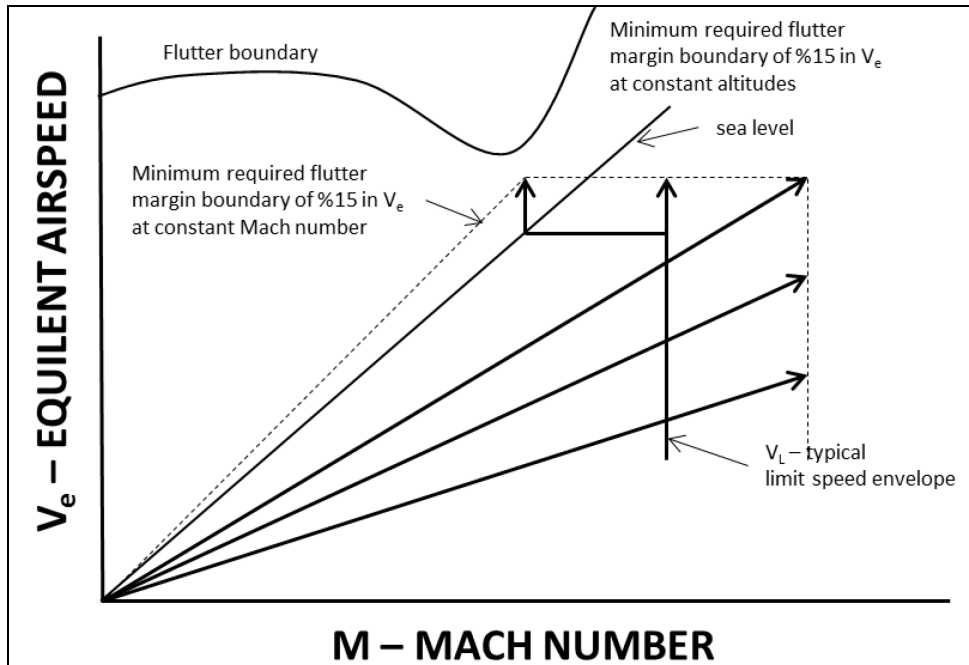

Figure 4-47: Minimum Required Flutter Margin [81].

- Damping:** The damping coefficient,  $g$ , for any critical flutter mode or for any significant dynamic response mode shall be at least three percent (0.03) for all altitudes on flight speeds up to the design limit speed as indicated in Figure 4-48, also obtained from [81].

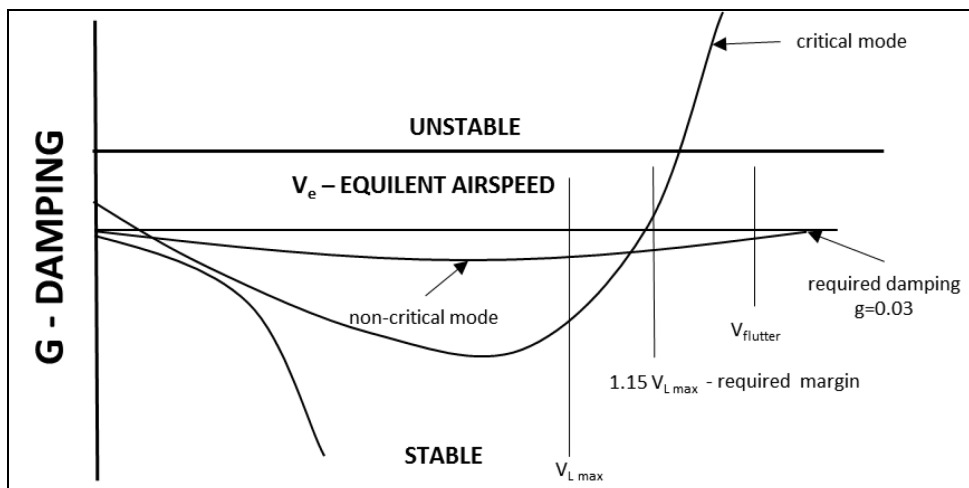

Figure 4-48: Required Damping [81].

The prime objective must always be to provide flutter free operation in the intended envelope of the test aircraft in a safe and economical fashion. This objective must be reflected in all subsequent flutter test activities.

The preliminary flight test plan should always be prepared by experienced flutter engineers based upon their analysis of flutter calculations and wind tunnel tests. They will determine where, in the planned flight envelope, it is safe to fly without flutter testing and where flutter testing is required. Where it is required they will specify the vibration sensors (accelerometers, preferably, and/or strain gage bridges, mostly available for other purposes), and their location in the aircraft. Using the same analysis and information they will specify the type of vibration exciters and where they are to be located. At this point the flight test and instrumentation engineers will participate in the detailed design of the instrumentation system and the excitation system.

Next, the flutter and flight test engineers must prepare a detailed flight test plan showing the combinations of speed and altitude that must be flown to demonstrate the freedom from flutter. Then a detailed sequence of testing must be prepared wherein tests are first flown at the conditions where analysis indicates that there are no predicted flutter problems. As each test point is flown, the test results are reviewed to ensure flight safety and compared to the predicted results. If the test results and the predictions disagree to a significant degree in the view of the flutter or flight test engineer, the tests are halted until the cause of the variance is explained.

The test plan must clearly specify the duties and responsibilities of all the test participants to include who has the specific responsibility for calling a halt to or proceeding on with a test series. In all cases, the test pilot has the authority to stop any test series if he detects any items that indicate any type of a departure from anticipated results [53].

Flight flutter testing comprises three steps:

- Structural excitation;
- Structural response measurements; and
- Stability analysis.

Accordingly, the data to be collected during the flight flutter tests can be divided into two groups:

- Those for measuring the excitation force; and
- Those for measuring the response of the aircraft.

In the first group, for measuring excitation forces, the sensor used will depend entirely upon the type of exciter used. For example, an electro-magnetic exciter will require the measurement of a current while a strain gage bridge will be required for measuring the vane excitation force.

In the second group, the most commonly used transducers are accelerometers and strain gage bridges. If amplitude accuracy is not critical, there is no clear preference between the two types. Strain gages are normally used only on new aircraft as they need to be installed during assembly of the aircraft since they are generally located in areas which are inaccessible once the aircraft has been assembled. On the other hand, accelerometers can be installed in many cases after the aircraft has been assembled. If the flutter tests are to be conducted on an existing vehicle, which is being equipped with new external stores, for example, the use of accelerometers may be dictated by the relative ease of installation. The two different types of sensor require quite different placement. In a wing, for example, the strain gage bridge will generally be applied near the wing root where the structural loads are large, whereas the accelerometer would be placed near the wing tip where the displacements are large. In the case of “classical” flutter, amplitude accuracy is not very critical since the engineer will be concerned with damping ratios rather than absolute amplitude. Good linearity is required for this case and it is essential that the phase relationship between the various sensors is of good quality. However, if non-linear phenomena, such as transonic aerodynamics and non-linear



control system characteristics are present, absolute displacement amplitude sizes become important as well. Consequently, a preference for accelerometers is becoming more common.

The selection of sampling rates for digitized data is critical. The consequence of sampling a fluctuating signal at too low a rate can be that high frequency signal components are interpreted as low signal components. To avoid this problem which is called data aliasing, the sampling rate for digitized signals should be at least twice the maximum frequency present in the original signal. It should be noted that the frequencies encountered in flight tests normally range up to about 50 Hz for transport type aircraft and 50 to 100 Hz for fighter type aircraft.

Despite the considerable improvements in test/analysis techniques that have been made in recent years, flutter testing is still a hazardous exercise. It is therefore important that the test aircraft not significantly overshoot the test points as it progressively clears the envelope. Therefore, airspeed and altitude must be controlled very accurately. As the testing approaches the boundaries of the envelope the airspeed tolerances usually become even more restricted with no positive tolerance allowed. In order to achieve these tight tolerances special airspeed and pressure instrumentation is generally required such as a trailing cone or special instrumentation mounted in a flight test nose boom [53].

It will be necessary to excite an aircraft in order to obtain the resonance frequencies and the corresponding damping coefficients of all required structural vibration modes to establish the flutter characteristics of the aircraft (see Figure 4-49). The means of excitation of the aircraft may be “natural” or “deliberate”. Natural in this context means that the aircraft response to the naturally occurring atmospheric turbulence is used so that no excitation equipment is required. Whilst this option may appear attractive it is not ideal as will become clear later on. Several means of “deliberate” excitation have been developed and applied that appear to be quite different from each other. However, a detailed examination reveals that they are based on a limited number of basic principles, such as aerodynamic, moving mass and pyrotechnic exciters. A brief description of each and their relative advantages and disadvantages are listed below. More detailed descriptions, factors involved in the choice of excitation device, and discussion are contained in references [82] and [83].

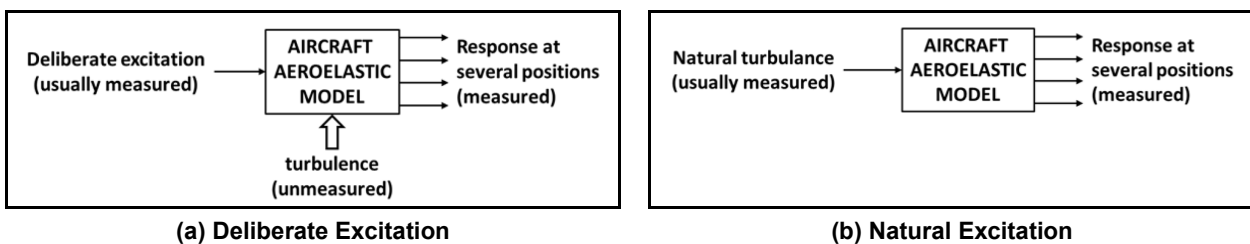

Figure 4-49: Identification of Dynamic Characteristics [83].

There are basically three types of aerodynamic excitation sources used in flutter testing. These are the aircraft control surfaces, special oscillating vanes attached to the tips of the lifting surfaces or to external stores, and atmospheric turbulence. The advantages of these excitation sources are that they add very little mass to the structure and that they can be used to provide a wide range of input frequencies.

In case of the control surface and oscillating vane excitation sources, the oscillating input force to the aircraft structure comes from changes in the aerodynamic lift on the oscillating surface. Such changes in aerodynamic lift can also be obtained by a rotating slotted cylinder along the trailing edge of a fixed vane. These sources can be used to provide either frequency sweep inputs (i.e. sweeping from low to high frequencies or vice-versa), constant frequency burst inputs, or random frequency inputs. In addition, control surfaces are also used for pulse or rap inputs which simulate impulse inputs to the structure. A further advantage is that it is usually possible to arrange aerodynamic excitation to be symmetric or asymmetric about the centerline of the aircraft, so aiding the process of separating out the structural vibration modes.



Atmospheric turbulence provides a random input to the structure which generally encompasses a spectrum of frequencies up to about 10 Hz. Even though the input is not generally felt by the pilot, there is always some energy content transferred to the structure from the air mass. However, the amount of input from this source is generally very small, which results in slow, unreliable, poor quality test data, compared to the other types of “deliberate” aerodynamic excitation sources and therefore is less satisfactory as pointed out in references [82] and [84].

There are basically two types of moving mass excitation sources: inertia exciters and electro-mechanical exciters. These exciters impart a force into the structure via inertial reaction of a moving mass attached to the aircraft structure. They are generally mounted inside the aircraft and therefore do not present any aerodynamic interference. These can provide frequency sweep, frequency burst and, in some cases, random inputs similar to the aerodynamic exciters.

Inertia exciters generally consist of a rotating out-of-balance mass mounted on a shaft which can be driven through the frequency range of interest. In some cases a “wand” is used which consists of a mass placed at the end of a pivoted arm attached to a shaft located at the tip of a wing or tail surface. One disadvantage of this system is that larger masses are needed to excite the lower frequencies and the overall system weight may become prohibitive.

Electro-dynamic exciters are similar to the electro-dynamic shakers used in Ground Vibration Tests (GVTs). In this case the force is generated by a mass excited by an electro-magnetic field. The mass is suspended by springs and consists of a permanent magnet with coil windings attached. When an alternating current is sent through another set of coils in close proximity, the mass can be made to move within the electric field. The frequency of movement is proportional to the electric signal. This system has the same advantages and disadvantages as the inertia exciter [53].

The pyrotechnic excitation source which is sometimes called a “bonker” consists of a very small explosive charge that is typically placed externally on the aircraft structure and detonated electrically. The tiny explosion produces an excitation of short duration. The actual time history of this force and, thus the frequency content can be controlled by the design of the exciter. Some of the advantages of this type of exciter are that the short duration of the excitation makes it useful for short flight maneuvers such as dives, and since the exciter is small, a number of them can be mounted almost anywhere on the aircraft without disturbing its vibrational characteristics. The disadvantage of this excitation source is the limited number of excitations (one per exciter) that can be produced during a given flight [53].

#### *4.4.3.2.1 Flight Test Procedures*

In the conduct of flutter tests, a sub-critical envelope expansion procedure is used whereby less critical points are flown prior to the more critical ones. The aircraft structural response data and flight parameters are also monitored in real time. This procedure provides the test engineer an opportunity to determine damping and frequency trends as dynamic pressure and airspeed increased during the test.

Generally, the buildup will consist of points of incrementally increasing airspeeds or Mach number which are flown at either a constant altitude or along a constant dynamic pressure line. If the buildup is flown at a constant altitude then it usually begins at a high altitude where the dynamic pressure will be the lowest. The airspeed increments between points will depend upon the proximity to the predicted flutter boundary and the confidence in the flutter analysis. Smaller steps are required when close to a flutter condition or when a rapid decrease in damping is observed. Some practical initial airspeed must be selected to begin the buildup sequence since the aircraft must take off and climb to the first test altitude. The choice of the initial test airspeed and altitude is based on a conservative review of the predicted flutter modes and flutter margin.

Clearly, the test program will differ according to whether the aircraft is to be cleared for low subsonic, high subsonic or transonic/supersonic speed regimes. In all cases a part of the flight envelope is cleared by

calculations for initial flying, obviously allowing a good margin of safety. Typical procedures for testing of these speed regimes are shown in Figure 4-50, obtained from [83].

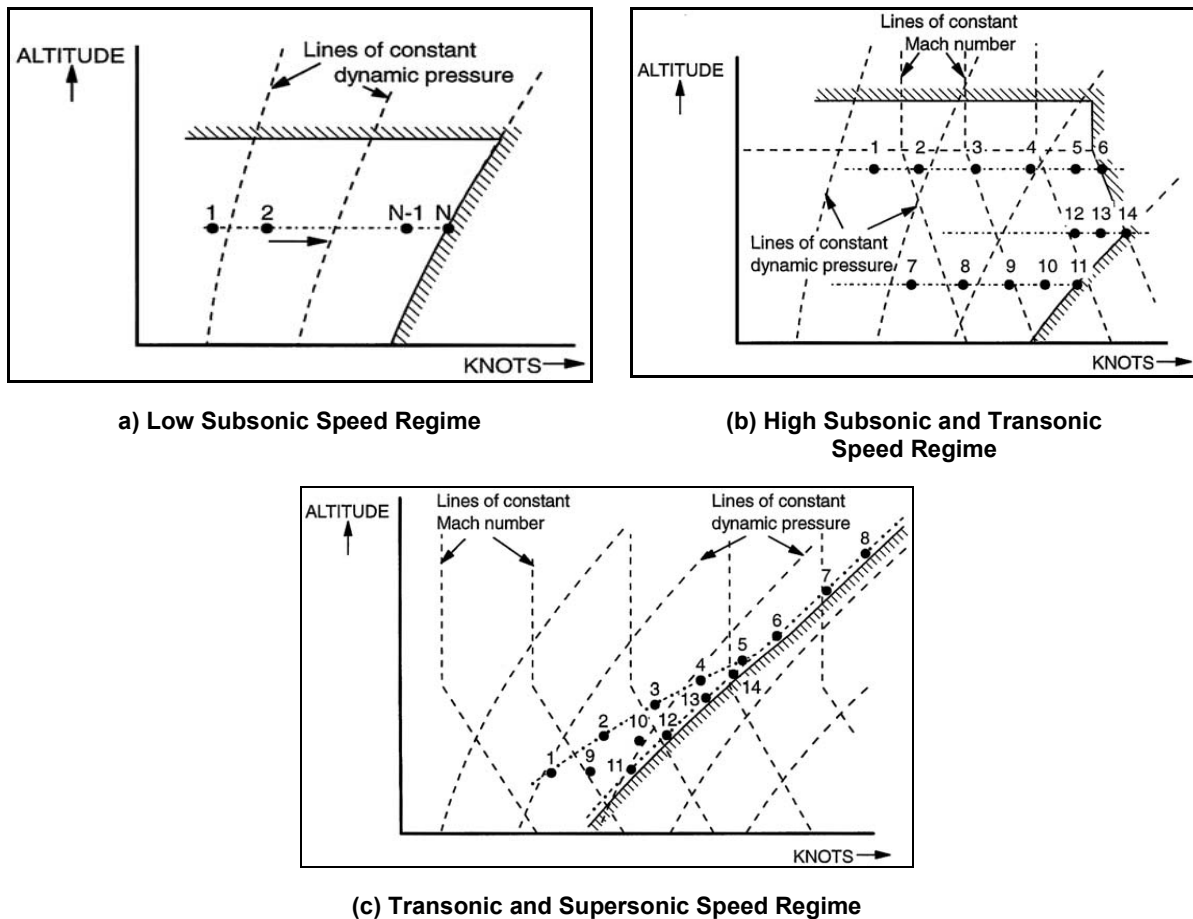

Figure 4-50: Flutter Test Procedures [83].

The maneuvers used in flutter testing depend upon the type of aircraft structural excitation available and the data to be collected. If sweep, burst, or random data is to be required, the aircraft will stabilize on condition (i.e. fly at a constant airspeed and altitude) for the time required to do the excitation. Generally, when dive test points have to be flown, the aircraft will reach a target airspeed, and the excitation data will be taken between a band of altitudes to prevent significant changes in the dynamic pressure during the maneuver. Sometimes, windup turns are carried out to determine the effect of g-forces on the aircraft flutter characteristics [53].

4.4.3.2.2 Data Acquisition and Analysis

Until relatively recent time, the measured signals were handled manually all the way to analysis in an analog format. This meant that only simple procedures could be applied unless time lapse did not play a significant role. In fact, trace recordings of time histories, particularly those of decaying oscillations, were processed manually and further evaluations in the frequency range domain were seldom performed. This process is still used, along with more sophisticated methods, for aircraft that are expected to exhibit one predominate critical modal response such as with aircraft with external stores or large transport type aircraft.

With the advancement of computers, plus improved data acquisition systems and the development of fast Fourier transform techniques, more complex analysis procedures involving two signals simultaneously in

both the time and frequency domain have been developed. It is now possible to produce real-time quantities such as auto spectra of input or output and transfer functions in the frequency domain and auto correlations of input or output, cross-correlations, and impulse responses in the time domain as discussed in Chapter 11 of [85]. In addition, new near real-time curve fitting techniques in both the frequency and time domains help expedite damping and frequency calculations.

Signals from the sensors often contain components of no interest to the flutter investigation and the data is subject to filtering before recording and/or analysis. Data from the sensors are normally always recorded on board the aircraft utilizing magnetic tape recorders and selected parameters are usually sent to the ground for “quick look” and inter-maneuver analysis by suitable specialists (large transport/cargo aircraft will often have equipment on board for analysis in flight). This not only reduces risk but permits more test points per flight. The analysis system is normally part of telemetry ground station. Data analysis can be done in real time using the data coming in via a telemetry link, or post-flight, using data recorded onboard the aircraft or on the ground station itself.

There is no need to process much of the data past the “quick look” stage. Data that is required to be processed further must be judiciously selected by the flutter engineer to avoid saturation of the data processing facilities [53].

The most important product resulting from the flutter test is the report providing clearances/limitations/special operating procedures as derived from test and data analysis.

Other products of importance to the flutter community are the quantities such as (in the frequency domain) auto-spectra of input or output, cross-transfer and transfer functions and (in the time domain) autocorrelations of input or output, cross-correlations, and impulse responses.

Another very important product is the validation or updating, as appropriate, of the flutter model developed as a result of the wind tunnel testing and data analysis [53].

Safety of flight must be the prime consideration when conducting flutter tests. Tests should not be continued, if in the opinion of the test pilot or the flutter engineer, unexpected results are encountered. Procedures must be clearly spelled out as to who has the authority to interrupt any given set of data points of the specified flight test program in order to conduct an inserted detailed data analysis.

All flutter tests should begin in that part of the flight envelope where wind tunnel data and data analysis unambiguously indicate freedom of flutter. Further tests should progress toward the anticipated edges of the envelope in carefully calculated increments that get smaller as less safe conditions are expected. Flight test data that show differences from predicted flutter and/or damping characteristics should result in a stand-down until the differences are explained and/or rectified.

The flight test engineer and the flutter engineer should carefully debrief the test pilot after each flight. Special attention should be given to pilot comments about any vibrations or oscillations experienced during each test point. These comments could provide valuable clues of which data to further process or of items to look for when processing data.

During real-time testing the flight test engineer should be continually on the look-out for trends in the damping and frequency that indicate that flutter could be imminent. This is performed primarily by monitoring the time signals or the processed data frequency and damping of the critical modes as a function of airspeed and/or dynamic pressure. If the damping starts to decrease at a faster rate than anticipated, then testing should be done at smaller increments or terminated. If the structural time history response starts to become more sinusoidal, with less relative noise, as the test progresses from point to point then the tests should proceed with extreme caution since flutter may occur. In any event, the damping coefficient should not be allowed to go below three percent [53].

Flutter can destroy or seriously damage an aircraft. Therefore, flutter considerations must be addressed early in the design process and the concern for flutter problems must be addressed at every stage of the aircraft's development and as early as reasonable in the flight test program. However, a vehicle representative of the production version must still be tested to provide representative data, especially if the aircraft is designed to carry a variety of stores [53].

#### 4.4.3.3 Environmental Effects Test

##### 4.4.3.3.1 Vibration Test

One of the essential parts of certification process is captive flight vibration tests on a store.

The tests are executed for a number of reasons. These reasons include:

- To determine if the store has been designed and tested to vibration conditions typical of service;
- To establish test levels for the store;
- To establish test levels for equipment within the store; and
- To investigate changes in vibration environments due to modifications to the aircraft or the store, or to changes in store carriage configurations, tactics, or operational flight envelopes [5].

Vibration and aeroacoustic tests should be combined when possible.

The test article should be a full scale store and should be carried on production suspension equipment. If it is not a production store it should be aerodynamically similar to the production store (shape and dimensions). If internal acoustic levels are to be measured then the test article should be a full-scale functional store. If not a production store it should be dynamically and aero-dynamically similar to the production store (inertia, stiffness, shape, dimensions) and contain a full set of equipment, wiring and plumbing. Experience has shown that dummy store internal acoustic levels are significantly different from stores with actual structure, shape and equipment installations.

There are basically five vibrational environments of concern based on jet aircraft:

- **Take-Off and Landing:** The maximum engine generated acoustic noise occurs at maximum thrust and zero ground speed. The maximum difference between exhaust plume and ambient air velocities occurs at this time along with maximum reflections of acoustic energy from the ground back to the aircraft. As the aircraft picks up forward speed acoustic noise drops off rapidly. However, as geometry changes during the take-off run acoustic reflections often cause local hot spots. Steady state measurements should be made at brake release conditions and transient measurements should be made during the take-off run and during catapulting. Airfield landings, and arrested landings during aircraft carrier operations, will cause significant shock and vibration loadings. Accelerometer recordings should be made during this portion of the airplane operations.
- **Dynamic Pressure and Mach Number:** General vibration levels in stores are generally related linearly to dynamic pressure and non-linearly to Mach number. Sufficient steady state measurement points and slow acceleration and deceleration points should be included to thoroughly define trends of vibration levels and worst case vibration levels within the flight envelope.
- **Maneuvering Flight:** Vibration levels vary with maneuver conditions. Measurements should be made during maneuver conditions characteristic of the aircraft/stores tactical mission(s) (windup turns, pitch-overs, pull-ups, throttle chops). In addition measurements should be made during any maneuver known to produce high vibration in the airframe.

- **Buffet:** In addition to dynamic pressure and Mach number severe low frequency vibrations occur on some aircraft during buffet. Sufficient measurements should be made to define store buffet environments.
- **Gunfire:** This may be during high angle of attack maneuvers or high-speed maneuvers. Sufficient in-flight and ground gunfire measurements should be made to define store gun fire environments.

The criteria of success of the test are given below:

- Sufficient data are recorded to define the vibration environments of the store throughout the flight envelope.
- Data quality is sufficient to allow accurate analysis/reduction of the measured data to final form.
- Reduced data of sufficient quality and quantity to meet the stated purposes of the test are provided to the user [5].

#### 4.4.3.3.2 *Aeroacoustic Test*

One of the essential parts of certification process is aeroacoustic flight test. The test is performed to determine the actual flight acoustic environment and to determine the ability of the store configurations to withstand and operate in the flight environment.

The flight data is required to validate the acoustic specification levels and/or to substantiate the predicted/test levels.

The reasons to perform this test is as the same as vibration testing apart from to investigate changes in the aircraft's aeroacoustic environments due to modifications to the aircraft or to changes in store carriage configuration, tactics, or operational flight envelopes.

The test article should be in the same characteristics as vibration test article.

Data required include the measured aeroacoustic levels at various locations on and in the store and the aircraft along with details of the aircraft, store and store carriage configurations and definition of the flight conditions at which the aeroacoustic data were acquired.

Flight conditions should be chosen to explore the aircraft/stores flight envelope. The following are based on jet aircraft. The environments to be concerned and success criteria are as the same as vibration testing [5].

#### 4.4.3.3.3 *Thermal Tests*

The thermal environment of flight varies greatly with the changes of the flight conditions. For a typical flight envelope (Figure 4-51) of an aircraft, the top left corner of the envelope represents the coldest and the bottom right corner represents the hottest environment during flight. The temperature difference between these two points rises up and above 100°C.

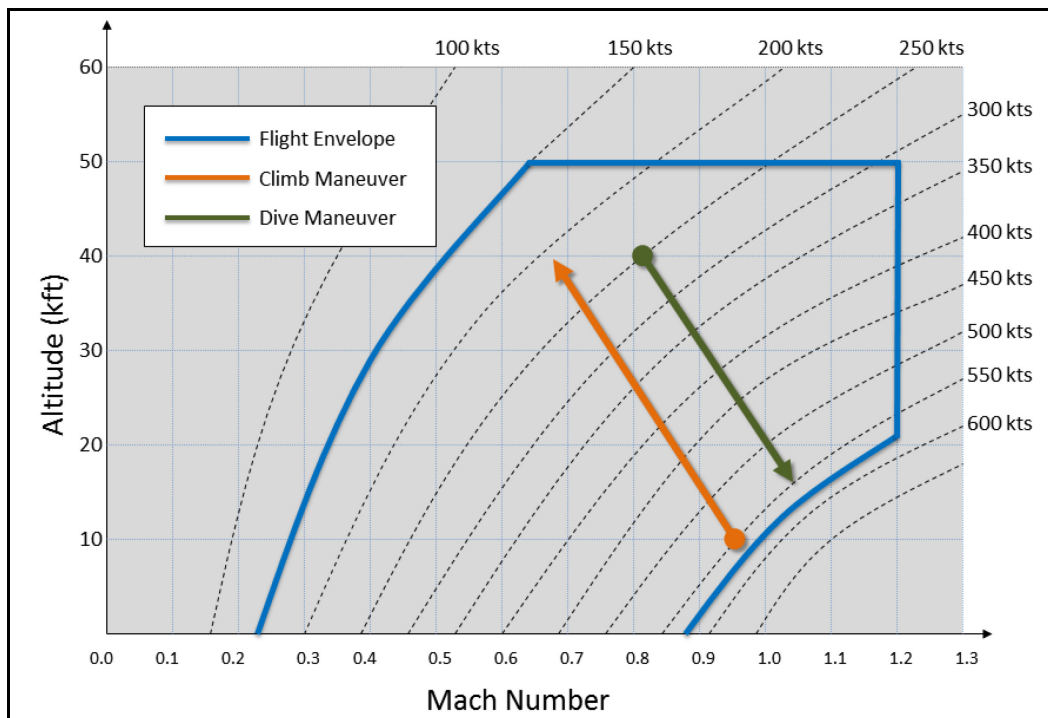

**Figure 4-51: Typical Flight Envelope of an Aircraft.**

The purpose of the thermal test flight is to determine if the test article/sub-systems can withstand the actual thermal environment of flight. Flight test results are also used to correlate with ground test and analytic results to improve/verify theory and test techniques.

The article tested should have the same physical and thermal properties as the proposed store insofar as possible. Explosive or hazardous materials should be simulated by non-explosive or non-hazardous materials having similar physical and thermal properties. The effects of differences in thermal properties of the test article and the actual article should be analyzed and documented in the final report.

The carrier aircraft should be chosen so as to provide the extreme conditions in the flight envelope, (e.g. Mach number, altitude and adjacent weapons carriage), as well as being compatible with the flight test mission from the data acquisition and instrumentation checkout aspect.

Test points (Mach number, altitude, ambient temperature) should be chosen within the flight envelope, which yield representative and extreme conditions on the test article. In addition, adjacent store configurations may be chosen to determine possible interference heating.

The recorded data should be of sufficient quality that its signal-to-noise ratio gives good confidence to the data quality. The data should be free of distortion and clipping of signals. The test article should perform to its thermal specifications at the most severe flight envelope conditions (hot and cold, operating and non-operating) [5].

#### 4.4.3.3.4 EMC/EMI Tests

EMC/EMI flight tests are performed to determine the ability of the aircraft/stores configuration to satisfactorily operate in flight and are only conducted when ground testing cannot demonstrate this. The effects of unintentional interaction between aircraft avionics systems and store electronic systems in all proposed configurations are investigated. EMI/EMC ground testing is normally used for this determination.



Flight EMC/EMI testing will only be used if ground testing of certain avionics or store electronics operating modes is not technically possible, or verification of ground test results is required. Such flight testing is normally only required for electronic warfare pods that are programmed to react to threats that cannot be simulated while stationary on the ground or when the presence of the ground interferes with test applicability. The effects of EMI can be very unpredictable. Consequently, EMC/EMI flight testing has the potential to be very dangerous, with EMI induced catastrophic failure of critical flight systems possible. In spite of the technical advances in testing and analysis techniques, EMC/EMI flight testing is potentially among the most dangerous flight testing and requires the utmost vigilance and expertise to avoid encountering catastrophic systems failures in flight. EMC/EMI testing of an aircraft store configuration may be conducted simultaneously with other flight testing, if safety of flight implications in the event of failure or the validity of either test will not be compromised.

EMC/EMI testing should follow a matrix developed by test personnel to ensure that all systems combinations requiring testing are adequately analyzed. Acceptable EMC is demonstrated by test results indicating that no system or sub-system experiences degradation of performance or creates a safety hazard due to the presence of other aircraft/stores system or sub-system [5].

#### **4.4.3.4 Flying Qualities Test**

The flying qualities tests demonstrate that the aircraft meets the requirements for the flying qualities of military piloted aircraft. These tests establish the limit within which the aircraft can be safely operated and ensure that the aircraft meets the goal of its design mission as related to flying qualities with any particular store or stores combination. The results of these tests also provide an accurate description of flight characteristics for inclusion in the aircraft flight manual. Care should be taken in design of this test so that worst case (possibly asymmetric) conditions are considered.

The selected design points must be sufficient to allow accurate extrapolation to the other conditions at which the requirements apply for the acceptance of the tests. When the requirements of MIL-F-8785 [86] or MIL-HDBK-1797 [87] are successfully applied to assure that no limitations on flight safety or on the capability to perform intended missions will result from deficiencies in flying qualities, then the flying qualities tests are acceptable. When the aircraft/stores, combinations are judged acceptable, i.e. meeting the flying qualities requirements presented by the procuring activity, then the tasks are said to be acceptable. The three levels of flying qualities for the three categories of flight phases defined in MIL-F-8785 or MIL-HDBK-1797 should be used for flying qualities test acceptance criteria [5].

#### **4.4.3.5 Performance and Drag Tests**

Performance and drag tests are required to determine what, if any, degradation in mission performance is caused by the carriage of external stores. Store loadings selected to be flown should be compatible with the anticipated operational requirements, and should yield a sufficient range of aerodynamic drag in order to be representative of all loadings. Results of these tests should be compared with those analytically derived and those data obtained from wind tunnel tests. In the event that the drag of any tested loading is unusually excessive, alternate, lower drag loadings should be selected, where practical, and tested [5].

The selected test points must be sufficient to allow accurate extrapolation to all conditions at which the store will be carried for the acceptance of these tests. The data must be such that a determination of the aircraft performance (acceleration, turn rate, climb rate) with various store loadings can be made throughout the Mach number/altitude envelope. The performance and drag of aircraft/stores combinations will be judged acceptable if the system specifications are met with no degradation in mission performance or, if any degradation is indicated, that degradation is determined acceptable by the procuring agency [5].

#### 4.4.3.6 Captive Flight Profile Tests

Captive Compatibility Flight Profile (CFP) missions are qualitative tests flown to evaluate the effect of a store configuration on aircraft flying qualities and store structural integrity throughout the required flight envelope. Un-instrumented aircraft are generally used for this purpose. There is no set of guidelines for CFPs which covers all situations so engineering judgment is necessary. Further guidance on test technique is provided in MIL-HDBK-244A [4]. Each new aircraft store configuration requiring certification should be evaluated using the following:

- **Handling Qualities Test:** A store, whose shape, mass, inertia properties or configuration are not analogous to another previously certified or tested item on that aircraft, should be flown for handling qualities. Store configurations to be flown to higher limits (airspeed or load factors) than analogous configurations require testing. Large, heavy stores which approach (but are not beyond) known mass, inertial and aerodynamic boundaries for the particular aircraft generally require CFP testing. Store configurations exhibiting characteristics beyond known aircraft limitations should be considered for real-time instrumented testing, not qualitative CFP testing. CFP handling qualities testing is not normally applied toward expanding the known flying qualities or design limitations of the aircraft.
- **Structural Integrity Test:** A store being considered for certification should be flown for structural integrity if no previous flight testing to analogous flight limits has taken place. Previous testing on another aircraft or in a different configuration on the candidate aircraft may be substituted, depending on engineering judgment. In general, one-of-a-kind developmental stores do not require this type of testing unless the store is intended for certification. Inventory stores already verified which undergo significant airframe modification should be tested. If a store is to be certified on numerous aircraft, the aircraft and configuration judged most severe with regard to structural integrity may be chosen for testing and thereby meet test requirements for all aircraft; keeping in mind different aircraft have different severe environments. For instance, some aircraft/stores configurations may require engine spillage testing to determine the aerodynamic load effects of transient engine inlet backwash/spillage if the stores are mounted in the vicinity of the inlet or in other vulnerable positions.
- **Endurance Test:** A store being considered for certification should be flight tested for endurance if no previous flight testing, analogous to the required flight limits has taken place. If lanyard routing is significantly different than previously flown, endurance and vibration may be necessary [5].

##### 4.4.3.6.1 Handling Qualities Test

This test is executed to evaluate the influence of the stores/suspension equipment on the handling qualities of the aircraft. This test establishes the limits within which the aircraft can be safely operated and ensure that the aircraft meets the goals of its designed mission as related to handling qualities with any particular store or stores combination. The results of these tests also provide an accurate description of flight characteristics for inclusion in the aircraft flight manual.

The test will be considered successful if acceptable handling qualities, as defined by the certifying agency, are observed by a qualified test pilot current in that aircraft. The selected test points must be sufficient to allow accurate extrapolations throughout the flight regime at which the handling quality requirements apply [5].

It is desirable that no store discrepancies occur during this test [5].

##### 4.4.3.6.2 Structural Integrity Test

The purpose of this test is to verify the structural integrity of the store and aircraft/stores combinations. This test demonstrates the ability of the stores loaded in a specific critical aircraft/stores configuration to withstand the aircraft ground and flight operational environment for periods of time longer than a single

mission. This test will evaluate preparation, flight and return with all stores still on the aircraft by performing flights to maximum symmetrical and unsymmetrical load factors at the maximum allowable speed without damage to or a failure of either aircraft, store, or suspension equipment. Engine spillage testing may also be required for some aircraft/stores configurations to determine the aerodynamic load effects of transient engine inlet backwash/spillage on stores mounted in the vicinity of the inlet or in other vulnerable positions. The degree of engine spillage is often a function of Mach number and engine spool speed and has been observed through so-called “throttle chop” maneuvers especially in the transonic flight regime. Un-instrumented operationally representative aircraft are generally used [5].

The test will be considered successful if no major store or aircraft discrepancies are observed throughout the flight envelope. During the test any store discrepancies should be recorded. After each sortie, visually examine the aircraft, suspension equipment, store combination for damage, failure, cracks, looseness or popped rivets. If significant discrepancies occur, discontinue testing and determine if the test should be repeated or discontinued. If lesser discrepancies occur (arming wire slippage, decals coming off), continue with sorties without correction of the discrepancies. After the sorties, examine the configuration both externally and internally, as necessary, for evidence of any discrepancies. All critical structural components in the store, aircraft ejector rack, and pylon should be visually inspected and non-destructively inspected as specified by the certifying agency. Conduct all necessary functional checks on the store to verify serviceability before, during, and after the test [5].

#### 4.4.3.6.3 *Endurance Test*

This test is flown to check the effect of a store loading configuration on the aircraft and store failures induced by the aircraft. Un-instrumented operationally representative aircraft are generally used for this test [5].

The test will be considered successful if no major store or aircraft discrepancies are observed throughout the flight envelope. During the test any store discrepancies should be recorded. After each sortie, visually examine the aircraft, suspension equipment, store combination for damage, failure, cracks, looseness or popped rivets. If significant discrepancies occur, discontinue testing and determine if the test should be repeated or discontinued. If lesser discrepancies occur (arming wire slippage, decals coming off), continue with sorties without correction of the discrepancies. After the sorties, examine the configuration both externally and internally, as necessary, for evidence of any discrepancies. All critical structural components in the store, aircraft ejector rack, and pylon should be visually inspected and non-destructively inspected as specified by the certifying agency. Conduct all necessary functional checks on the store to verify serviceability before, during, and after the test [5].

#### 4.4.3.7 **Employment Tests**

Employment tests are the part of the flight testing which requires part or all of the stores to be released from the aircraft. These tests include release, launch, gun fire and dispense tests.

Even though wind tunnel tests are widely used to predict employment characteristics, flight testing is normally considered mandatory to demonstrate, as a minimum, envelope extremes. Many occasions will arise when employment analogies or simulations are not available or sufficient and flight testing is the only available tool to determine safe employment envelopes:

- Employment means to release, launch, fire, or dispense part or all of the selected stores from the aircraft. Employment in many cases is characteristically different from jettison. Jettison is the safe release of stores from the aircraft and is done simply to separate the stores from the aircraft for safety or performance reasons. During employment tests, the store is operated in its normal mode to accomplish an operational objective as opposed to jettison, which is usually accomplished in 1 g level flight.

- Employment testing is often accomplished throughout a large part of the aircraft flight envelope to demonstrate that the store or store part will safely and satisfactorily separate from the aircraft. As a side benefit, through a well-structured employment test, valuable parametric insight into basic aircraft/stores employment characteristics can be obtained.
- It is easily conceivable that a store will be designed that could dispense as it separates from the aircraft, or otherwise combine more than one of the four types of employment modes. For such cases, several standard tests may have to be combined to properly evaluate safe employment [5].

#### *4.4.3.7.1 Release Test*

Release tests are performed when, during normal employment, the entire store is released from its suspension equipment. Guided and un-guided iron bombs and clusters, fire-bombs, and nuclear weapons are examples of weapons that are normally released during employment. Release tests are performed to demonstrate that the store or the sub-munitions within a cluster bomb will safely and satisfactorily separate from the aircraft throughout the employment envelope. It is important to understand that a store must not only separate safely from the aircraft, it must also separate without undue disturbance of its ballistic trajectory. It is of little value to the mission if the store, or stores, separate with no safety problem, only to have separation disturbances perturbate the weapon's trajectory to the point that the intended target cannot be hit.

A good separation, then is one which is not only safe, but also relatively benign to the weapon trajectory [5].

#### *4.4.3.7.2 Jettison Tests*

Jettison is done for internal/external stores to rid the aircraft of their weight, drag, or other undesirable characteristics. Virtually any type of store may be jettisoned, but typical examples are fuel tanks and empty dispensers. Jettison may occur in an emergency to improve aircraft survivability or just to avoid the carriage of an item of questionable value and safety. Since the jettison of stores is not always a pre-planned event, the speed limits to which a store may be jettisoned should be as wide as possible. Jettison is normally done in straight and level flight, but there are exceptions. Munitions are normally jettisoned safe. Jettison of empty dispensers may be desirable to reduce acoustic vibrations generated by dispenser cavity resonances [5].

### **4.4.3.8 Ballistics Test**

An integral part of certification of a weapon for carriage and release from an aircraft is the assurance that the weapon, when employed, will hit the target by providing the user with weapon delivery mission planning data as well as the ballistic and/or in-range/shoot-cue algorithms, respectively, for both ballistic and guided weapons for inclusion in the OFP. The weapon's accuracy and ballistic/guided flight path must analyzed and release data prepared to provide the aircraft flight crew with weapon release system settings and delivery procedures for various flight conditions. This test defines the data requirements needed for collecting and reducing the weapon test data in order to model the ballistics and/or guidance and control system of the weapon and defines the ballistic accuracy verification process. Each new aircraft/stores configuration should be evaluated using the following general guidelines [5].

#### *4.4.3.8.1 Weapon Free-Stream Ballistics Test*

In instances where baseline aircraft independent ballistics have not been established for the weapon, they are to be determined and modeled. This modeling will include the free-stream drag coefficient, dispersion characteristics and event times for the weapon, independent of the aircraft. The data will normally be obtained during weapon DT&E. Every effort should be made to ensure that any data obtained from this test is used to reduce the number of sorties required for later ballistic tests. Therefore, the data requirements and ballistic data reduction for Tests 292, 293, and 294 should be included with the requirements for Test 291. Accurate modeling of the weapon free-stream ballistics is essential since an error in this model could falsely indicate a need to conduct separation effects derivation testing [5].

#### 4.4.3.8.2 *Aircraft/Weapon Ballistic Accuracy Verification Tests*

Due to the extent of the testing required to adequately verify aircraft/weapon ballistic accuracy, the using command should clearly identify to the certifying agency the specific aircraft/weapon configurations requiring verification and OFP optimization in addition to clearly defining the accuracy acceptance criteria. The ballistic accuracy verification process consists of three phases.

#### 4.4.3.8.3 *Operational Flight Program (OFP) Ballistics Evaluation*

The objective of this test is to evaluate the initial accuracy of the OFP ballistic algorithms. The ballistics of the OFP during this phase should consist of the free-stream ballistics of the weapon. If available, separation effects gathered by analogy with a similar store, or from wind tunnel tests, will be incorporated to the maximum extent possible. The evaluation of the ballistics includes a CEP test and a range bias test. If both CEP and range bias evaluations meet the acceptance criteria, then the ballistic accuracy of the OFP for the particular aircraft/weapon configuration will have been verified and Tests 293 and 294 will not be required. For guided weapons, in-range/shoot-cue algorithms and/or release envelopes should be evaluated for inclusion in the aircraft OFP [5].

#### 4.4.3.8.4 *Separation Effects Derivation Test*

The objective of this test is to derive the separation effects coefficients for the preferred aircraft/stores configurations. Separation effects models account for the motion of the weapon from the moment it is released until all oscillations caused by the aircraft flow field are damped. Separation effects are currently modeled as a function of release variables such as Mach number, normal acceleration, angle of attack, and dynamic pressure. These coefficients will be used to compensate for separation effects and may be incorporated into the ballistic tables and/or into a separation effects algorithm in the aircraft ballistic OFP. The coefficients used in the separation effect algorithm may result in aircraft velocity adjustments used in the air-to-surface trajectory calculations or may cause incorporation of changes in the mode of trajectory calculation. A thorough understanding of the aircraft and the weapon system being tested as well as the intended use of the weapon is paramount in designing a successful test matrix [5].

#### 4.4.3.8.5 *OFP Ballistic Verification Test*

The objective of this test is to verify the ballistic accuracy of the OFP. The ballistics at this point in the process consist of both the free stream drag curves and the derived separation effect coefficients. The ballistic accuracy verification phase is identical to that performed in the OFP ballistic evaluation phase. A CEP and range bias evaluation are performed and compared to the acceptance criteria. In determining the bombing accuracy of an aircraft weapon system, one of the most important decisions that must be made is the number of weapons to be dropped in each configuration. Enough weapons should be dropped to ensure the data obtained is statistically significant. The process of refining the aircraft ballistics OFP can continue until the acceptance criteria is achieved or until the user accepts the results, accepts an aim point offset, or cancels the requirement for that configuration [5].





## Chapter 5 – DOCUMENTATION

Reports are an essential part of aircraft/stores compatibility, integration and separation testing. They often include the results, followed approaches, philosophy of the effort for system engineering, analysis, ground and flight testing. Because of variety of areas, the type, content, and depth of reports are as varied as the number of management, analysis, and test agencies.

General approach for the test reports for each test is to cover the test objectives, test article, instrumentation, procedures, data requirements, results and conclusions. Each failure and anomaly should be discussed along with reasons for failure and proposed design changes to correct the problems. Test reporting procedures use MIL-HDBK-1763 a guideline for documentation of test planning and test results [5].

### 5.1 REPORT TYPES

There are three types of report suggested [5] according to their purpose and content:

- Data report;
- Final report; and
- Compatibility report or airworthiness qualification report (for the Army).

These report types are only suggestions not requirements. Different types of reports can be used for different campaigns.

#### 5.1.1 Data Report

A data report could also be called a facility or test report and contains detailed test plans, description of test articles, facilities, equipment, instrumentation, conditions, procedures and sequences, test results, observations, data, and data accuracy, and conclusions and trends that are obvious from a cursory review of the data. The purpose of the report is to document the test (experiment) and transmit the data to the test requester. The data report should avoid judgments or conclusions about the utility of the data. For example, a structural test report might state that the test item did not fail but should not state that, having successfully passed this test, the item is qualified for some purpose. In a similar vein, the report on a wind tunnel or flight test investigating store separation might note that no store hit the aircraft and all stores pitched nose down, but it should not conclude that safe or satisfactory separation was demonstrated. Data reports usually only address one narrow aspect of the overall certification efforts and should not be depended on to discuss the entire effort. Data reports would receive narrow distribution, primarily to the test requester. Interim reports on test progress may be desired in addition to the final data report. There may also be times when, due to the urgency of the certification effort, it is desirable to issue an informal final report to avoid the long time delay associated with a published report [5].

#### 5.1.2 Final Report

Since very few agencies have the variety of facilities needed to conduct all of the tests discussed in MIL-HDBK-1763 [5], it is likely that the certification agency will have to solicit the support of several outside agencies to conduct some of the necessary tests. Each of these facilities will probably only provide a data report addressing, in detail, their specific test. At the completion of all work on a specific store certification, it may be desirable to generate a final or summary report to discuss the requirements for the certification, compile and discuss all the analyses and tests conducted, cite test philosophy, draw conclusions about the operational or engineering suitability of the test results, and specify, in general terms, the certification envelope ultimately recommended. Aspects of specific tests that are of particular interest

would be discussed in some detail, but the actual data reports would be presented either as annexes or simply referenced. Correlation between simulations and test results would be presented. The final report would be of interest to many management and technical members of the aircraft/stores analysis/test community and should therefore be published and given wide initial tri-service distribution [5].

### **5.1.3 Compatibility Report or Airworthiness Qualification Report (for the Army)**

Certification agencies often rely on an aircraft/stores compatibility agency to manage, conduct, and evaluate the analyses and tests conducted in support of their certification requirements. Compatibility reports should be provided by the compatibility agency to the certification agency to summarize and document the analyses, test conducted, the conclusions drawn about the operational suitability of the aircraft/stores combination and to recommend, in the format of the flight delivery, and loading manuals, the manner in which the store should be authorized. The compatibility agency in conjunction with the certification agency should maintain a record of all testing, analyses, and rationale used in the certification of all aircraft/stores configurations authorized in the flight manual. Also included in this record should be the approved delivery and loading manuals for the store [5].

## **5.2 GROUND TEST REPORTS**

Following suggestions for reporting efforts are given in MIL-HDBK-1763 [5] and is for guidance only. They are not requirements.

### **5.2.1 Fit Test Reports**

The test report should detail the extent of physical compatibility established in the test. Aircraft, stores suspension equipment and stores test articles and equipment should be identified by model and serial number and other models of the test articles to which the test results do or do not apply should be identified. This will assist in any post-test review conducted later if problems occur with store fit and function when the configuration is used by operational units. To adequately report some tests, it will also be necessary to include electrical wiring diagrams to clearly define the test aircraft, suspension equipment, and test item configuration(s) actually used. The final loading procedures should be completely detailed. Clearances measured during the test should also be presented and photo-documented, if possible, and comments made as to whether or not they are adequate. Particular attention should be paid to any deviation to the requirements of AIR STD 20/21 [88] and statements made as to the recommendation of waivers and justification thereof [5].

### **5.2.2 Function Test Reports**

The test report should detail the extent of compatibility established in the test. Aircraft, stores suspension equipment and stores test articles and equipment should be identified by model, OFP used, and serial number and other models of the test articles to which the test results do or do not apply should be identified. This will assist in any post-test review conducted later if problems occur with aircraft/stores function when the configuration is used by operational units. To adequately report some tests, it will also be necessary to include electrical wiring diagrams and interface control documentation used to clearly define the test aircraft, suspension equipment, and stores test item configuration(s) actually used [5].

### **5.2.3 Static Ejection Test Reports**

The data variance for each ejection should be provided for any given Ejector Release Unit (ERU) or day listed numerically. Static conditions that change only periodically should be so listed for the sequence of ejections to which they are applicable. Reasons for or causes of failure in mechanical arming and control systems should be documented. The test report should include all the data listed below:

- ERU type and identification (nomenclature and serial number);
- ERU mounting details;
- Store(s) type and identification;
- Store characteristics (weight, c.g. location, moments of inertia);
- Ambient conditions (temperature and humidity);
- ERU characteristics;
- Pitch or force setting, if used (and orifice size, if used);
- Ejector position with respect to store c.g.;
- Ejector stroke length;
- Sway brace torque, force;
- Attitude of store and ERU with respect to horizontal;
- Hydraulic system pressure (if applicable);
- Cartridges used;
- Time/number of firings since last cleaning (if applicable);
- Ejector power source characteristics and identification;
- Reaction forces between store and ERU (fore, aft, center, sway braces);
- Lag time in accordance with MIL-T-7743;
- During store ejection, the following data should be taken at the store c.g.;
- Ejector stroke versus time (all ejectors);
- Ejection force versus time;
- Ejection velocity versus time;
- Acceleration versus time;
- Pitch attitude and rate;
- Yaw attitude and rate;
- Roll attitude and rate;
- Dynamic response of mounting rig versus time;
- Simulated external air loads applied, if applicable;
- Photographic record; and
- Remarks on the results of correct lanyard function for armed and jettison/safe releases including reliability and confidence levels achieved [5].

#### 5.2.4 Ground Vibration Test (GVT) – “Big” Modal Test Reports

The GVT report should contain the following information:

- Plots of the amplitude versus frequency for strategically located vibration pickups;
- The natural frequency, mode shape, damping and node line location for all modes that are measured along with their theoretical counterparts; orthogonality checks; and

- Descriptions and photographs of the air vehicle suspension system, the excitation system, the instrumentation, the procedures and the air vehicle onfiguration along with mass distributions used for the orthogonality checks [5].

## **5.2.5 Wind Tunnel Tests Reports**

### **5.2.5.1 Effects of Aircraft on Captive Stores/Suspension Equipment Reports**

Whether the data are to be tabulated, plotted, or recorded on magnetic tape depends on the user's requirements and capability of the facility in satisfying the user's needs [5].

#### *5.2.5.1.1 Data Reports*

The data report should include the data stipulated below. The data report should also include model scale, definition of the configurations tested, instrumentation accuracy, test repeatability, wind tunnel test conditions, plots or tables of the test data and details of any corrections or modifications to the data. If aerodynamic coefficients are derived from the data or combinations of the data, specify the equations used, the sign convention, and the appropriate reference dimensions. The data report should include sufficient detail to completely describe the test and document the accuracy of the data.

In addition to the store/suspension equipment force and moment or pressure data, general tunnel and model data should be included, such as:

- Mach number;
- Tunnel static temperature;
- Tunnel dynamic pressure;
- Tunnel unit Reynolds number;
- Model configuration identification;
- Model attitude;
- Tunnel porosity; and
- Tunnel dew point [5].

#### *5.2.5.1.2 Final Report*

The final report should include the compatibility conclusions already addressed in the data report. The report must contain the criteria for compatibility conclusions, and the analysis method used to determine the conclusions [5].

### **5.2.5.2 Effects of Captive Stores/Suspension Equipment on Aircraft Reports**

Same reporting contents should be presented as given in Section 5.2.5.1 [5].

### **5.2.5.3 Aeroelastic Effects Test Reports**

The report on the flutter model tests results should contain the date and place of tests, the model flutter parameters as compared with similar parameters of the full-scale airplane, drawings and photographs of representative models, and of the model support. The report should contain the results of tests used to determine that the model does simulate the airplane. The report should also include the test conditions, the mode and frequency of flutter encountered if flutter occurs, plots of the damping coefficient and

frequency versus velocity if transients are measured, plots of the flutter speed and frequency versus the variation in important parameters if a parametric study is performed, and comparisons of test results with the results of theoretical flutter analyses on the model. The method of correcting for compressibility should be included. Plots showing the wind tunnel characteristics and indicating the flutter boundary that must be attained (including the flutter margin) should also be included. All data should be presented in terms of both model parameters and airplane parameters [5].

#### **5.2.5.4 Store Separation Tests Reports**

Suggestions for the data reports are given in Section 5.2.5.4.1 and 5.2.5.4.2. In addition to those, the suggestions given in Section 5.2.5.1 should be used.

##### *5.2.5.4.1 Dual Support Method*

As a minimum for on-line trajectories, a tabulated computer printout must be provided. Printout information should include, but not be limited to, aerodynamic forces and moments, position, velocities, accelerations, Mach number, and angular attitudes and rates as a function of time. Some of these may be relative to the inertial reference (usually the flat surface of a non-rotating earth) or relative to the aircraft. Some facilities provide plotted data for selected information during testing. In addition, the output may consist of plots or schematics to assist in data analysis:

- In a grid test, the store force and moment coefficients (actual and corrected) as a function of position and attitude relative to the aircraft must be provided. Mach number and aircraft attitude also must be provided. In addition, the output may consist of plots or schematics to assist in data analysis.
- The data reported from flow angularity and pressure testing depends on the degree of sophistication of the equipment involved. The recorded data may include position, Mach number, aircraft angle of attack/sideslip, and manometer or transducer readings which must be converted to pressure. The pressures in the normal/side plane of the angularity probe are used to calculate the normal/side velocity components. The total and static pressures are used to calculate dynamic pressure. These data are given at the various positions along with the Mach number, and aircraft angle of attack/sideslip [5].

##### *5.2.5.4.2 Dynamically Scaled Drop Method*

The most condensed form of the photographic record is multiple exposure prints. These photographs may be used to calculate velocities and accelerations if the timing intervals of the multiple exposures are known. As a minimum, run number should be shown on each print. Another record is motion picture prints. The motion picture prints may be used to calculate velocities and acceleration if the film speed is known. As a minimum, run number should be shown on each print. If two or more cameras are used, synchronization is required. The output should include plotted data from the photos in the form of store position and attitude [5].

##### *5.2.5.4.3 Final Report*

The requirements of Section 5.2.5.1.2 must be met.

#### **5.2.6 Environmental Tests Reports**

##### **5.2.6.1 Vibration Test Reports**

The test report should cover the test objectives, test article, instrumentation, procedures, data requirements given below, results and conclusions. Each test failure and anomaly should be discussed along with reasons for failure and proposed design changes to correct the problem(s).

The test should verify that the store survives and operates satisfactorily in the flight, ground, and aircraft carrier vibration environments. The data required should verify that the test was properly conducted, should document local vibration responses to the store, and should contain the following:

- A description of the test set-up supplemented by drawings and photographs.
- A list of the rigid body suspension modes including frequencies and mode shape descriptions.
- A list of the equipment and instrumentation used in the test.
- A copy of the test procedure including test levels, durations and tolerances.
- A copy of the test log.
- Measurements of the vibration response of the test item at the beginning, end, and at appropriate intervals during each test run. Unless specifically agreed to prior to the test, this data should be in acceleration spectral density in  $g^2/\text{Hertz}$  versus Hertz units on a log-log format.
- Any additional response measurements made during the test. Measurement times and data formats appropriate to the particular measurement are acceptable, however, the format stated above is recommended for general use. (If possible, all plots should have the same frequency scale and all amplitude scales should be consistent in the linear (plotted) dimension per decade (10 dB)).
- Copies of the functional performance check sheets.
- Include the data required by aeroacoustic test [5].

#### **5.2.6.2 Aeroacoustic Test Reports**

The test report should cover the test objectives, test article, instrumentation, procedures, data requirements of vibration test (Section 5.2.6.1), results and conclusions. Each test failure and anomaly should be discussed along with reasons for failure and proposed design changes to correct the problem(s).

#### **5.2.6.3 HERO Reports**

The test report should cover the test objectives, test article, test instrumentation procedures, data requirements given below, results and conclusions.

Assessment of the immunity of an electrically initiated device (EID) is based upon its no fire threshold. For acceptance, test results must demonstrate that any stimulus induced in an EID circuit in the specified EME will not exceed a given level expressed as a margin in dB below the maximum no fire threshold sensitivity for the subject EID. The required margins, as specified MIL-STD-464C [77], distinguish between safety (16.5 dB) and other applications (6 dB) and allow for measurement uncertainties, such as test instrumentation, EME levels, system configuration, etc. A detailed description of the electrical characteristics is required to perform the pre-test analysis and to evaluate the test results. The following characteristics should be available:

- Maximum no-fire D.C. stimulus of each EED;
- Radio frequency impedance of each EED;
- Radio frequency sensitivity of each EED;
- Launcher and ordnance wiring diagram showing all connector wire paths, switches and EID locations; and
- A detailed description of the prescribed test, handling and loading procedures, including identification of ground support equipment (optional for Air Force) [5].



#### **5.2.6.4 EMC/EMI Reports**

The documentation phase consists of reporting the recommendation on certification. The report should display and interpret the pertinent data which led to the recommendation and should clearly state the configuration for which the recommendation applies. The final report, technical data, and working papers for the project should be forwarded to the tasking agency. If applicable, the final report should clearly state when official waivers are necessary. When waivers are needed, the appropriate agencies will be provided copies of the final report and other pertinent documentation for review and approval [5].

#### **5.2.6.5 Temperature Effects Reports**

The test report should cover the test objectives, test article, instrumentation, procedures, results and conclusions. The data report and the final report form a part of the test report. The definitions of these reports are given in Section 5.1. Submitted reports should be in accordance with specific guidance provided by the certification agency [5].

### **5.3 FLIGHT TEST REPORTS**

Following suggestions for reporting efforts are given in MIL-HDBK-1763 [5] and is for guidance only. They are not requirements.

#### **5.3.1 In-Flight Loads Test Reports**

The reports required for this testing should be specified by the certifying authority and should include but not be limited to:

- Flight test plan;
- Instrumentation report;
- Calibration report;
- Initial phase report and loads comparison;
- Final phase report and loads comparison; and
- Ground phase report and loads comparison.

The contents of these reports are specified in MIL-A-8868. The test report must clearly document the actual parameters attained during the test, highlighting any deficiencies found during the post-flight inspections along with proposed design changes to correct the problem(s) [5].

##### **5.3.1.1 Flutter Test Reports**

The test report should cover the test objectives, test article, instrumentation procedures, data requirements given below, results and conclusions.

The test data required are the structural response frequencies of the wings, pylons and stores and the associated response amplitudes and damping along with their changes with increasing dynamic pressure and Mach number. Gradual or sudden decreases in damping, usually with increases in response amplitudes and the coalescing of two response frequencies generally indicate approaching flutter. Other test data required are the configuration logs, aircraft fuel loading and usage, airspeed, altitude, air temperature, and barometric pressure [5].

## 5.3.2 Environmental Test Reports

### 5.3.2.1 Vibration Test Reports

The test report should cover the test objectives, test article, instrumentation, procedures, data requirements given below, results and conclusions. Each failure and anomaly should be discussed along with reasons for failure and proposed design changes to correct the problem(s).

Data required includes the measured vibration levels at various locations in the store (and suspension equipment if required). The nature and magnitude of the vibration induced in a store is a sensitive function of the aircraft/stores configuration. Therefore, for each flight test, the configuration must be fully documented. The following is based on jet aircraft. Note that frequency spectra are always necessary. Measurement of peak g at blade (rotor) passage frequency and a few harmonics are not sufficient. These spectra are continuous with approximately sinusoidal components superimposed on a continuous vibration background. This documentation should include:

- A description of the test configuration supplemented by drawings and photographs including description of any modification to the aircraft which would affect the airflow around the aircraft and any deviations from standard technical orders procedures for loading/installing stores on the aircraft.
- Description of store to be flight tested. A list of instrumentation including specific locations and orientations of each sensor supplemented by drawings and photographs should be included.
- Identification for the flight test conditions at which measurements were made including:
  - Indicated airspeed;
  - Mach number;
  - Altitude;
  - Ambient temperature;
  - Angle of attack;
  - Angle of yaw;
  - Normal load factor; and
  - All configuration variations such as speed brake position, high lift device(s) position, bomb bay door position and firing or ejection of weapons or stores.
- A list of the data analysis equipment including pertinent technical data.
- A description of the data analyses including equipment flow charts, technical parameters and data sample selection criteria for each type of analysis.
- Copies of the reduced data. Each plot should be annotated with sensor identification(s) and flight condition. Reduced data should include:
  - Samples of time histories (grms versus time) showing analysis sample selections;
  - Acceleration spectral density plots ( $g^2/Hz$  versus Hz) in log-log format for steady state analyses;
  - Time histories (grms, 1/3 Octave band grms, or other appropriate amplitude parameter versus time) of transient events;
  - Selected frequency domain plots of steady state conditions for comparison to transient event time histories;
  - 1/3 Octave band acceleration spectral density plots when required for correlation with acoustic data from Acoustics Test;

- Other forms as appropriate to a specific test; and
- All plots should have consistent amplitude scales and frequency domain plots should have the same frequency scale [5].

### 5.3.2.2 Aeroacoustic Test Reports

The test report should cover the test objective, test article, instrumentation, procedures, measurements given in Section 5.3.2.1 results and conclusions. Each failure and anomaly should be discussed along with reasons for failure and proposed design changes to correct the problem(s).

Data required include the measured aeroacoustic levels at various locations on and in the store and the aircraft along with details of the aircraft, store and store carriage configurations and definition of the flight conditions at which the aeroacoustic data were acquired:

- A description of the test configuration supplemented by drawings and photographs including description of any modification to the aircraft which would affect the airflow around the aircraft and any deviations from standard technical orders procedures for loading/installing stores on the aircraft.
- Description of store to be flight tested. A list of instrumentation including specific locations and orientations of each sensor supplemented by drawings and photographs.
- Identification for the flight test conditions at which measurements were made including:
  - Indicated airspeed;
  - Mach number;
  - Altitude;
  - Ambient temperature;
  - Angle of attack;
  - Angle of yaw;
  - Normal load factor; and
  - All configuration variations such as speed brake position, high lift device(s) position, bomb bay door position and firing or ejection of weapons or stores.
- A list of the data analysis equipment including pertinent technical data.
- A description of the data analyses including equipment flow charts, technical parameters and data sample selection criteria for each type of analysis.
- Copies of the reduced data. Each plot should be annotated with sensor identification(s) and flight condition. Reduced data should include:
  - Samples of time histories (Sound Pressure Level (SPL) versus time) showing analysis sample selections;
  - 1/3 octave band SPL versus frequency plots in semi-log format of steady state events;
  - Time histories (SPL, 1/3 octave band SPL, or other appropriate bandwidths versus time) of transient events;
  - Other forms as appropriate to specific tests; and
  - All plots should have consistent amplitude scales and frequency domain plots should have the same frequency scale [5].

### 5.3.2.3 Thermal Test Reports

The test report should include the critical component temperature-time history as well as the heat flux and wall temperature distributions. In addition, the report should describe the test set-up, hardware, instrumentation and results in tabulated and plotted form.

### 5.3.2.4 EMC/EMI Test Reports

The test report should cover the test objectives, test article, any instrumentation used, data requirements given in Section 5.2.6.4, results and conclusions. Each failure and anomaly should be discussed along with reasons for failure and proposed changes to correct the problem [5].

### 5.3.3 Flying Qualities

The flying qualities demonstration data report should contain quantitative data and qualitative information, as appropriate, documenting compliance with requirements of MIL-D-8708 [89], SD-8706 [90], and MIL-HDBK-244 [4]. Also, spin demonstration data reports, as defined in MIL-D-8708, should be provided [5].

### 5.3.4 Performance and Drag Test Reports

Flight test reports should be prepared and should satisfactorily document the results obtained, in the form of quantitative data and qualitative assessments, depending upon the type of goals of the specific flight tests. These reports should be submitted as required by the procuring agency. It is recommended that such test reports be divided into two sections:

- Pertinent discussion relating to the findings, goals, conclusions and recommendations; and
- Complete data compilation, including explanations of symbology and terms, presented in an easily understood and translated format [5].

### 5.3.5 Captive Flight Profile Test Reports

#### 5.3.5.1 Handling Qualities Test Reports

For flying and handling qualities tests, the test report should be prepared which documents the test results. The test report should document to the certifying agency the flight test limits actually achieved, the test aircraft/stores configuration and any discrepancies noted. It is recommended that terms such as “Clean or Basic Aircraft Limits (CAL or BAL)” were demonstrated not be used. Instead the actual parameters achieved during the tests such as 700 KIAS/1.40 Mach, -1.00 to +7.33 symmetrical g’s, -0.5 to +5.5 unsymmetrical g’s should be used, since the value of BAL or CAL may change with improved engines or subsequent aircraft upgrade programs. Flying qualities will be reported using qualitative comments and the Cooper-Harper Rating Scale and/or the Pilot-Induced Oscillation Rating Scale where appropriate tasks are defined. The report should document any significant change in aircraft handling qualities from the basic aircraft with respect to any phase of flight or ground operations. Store discrepancies resulting from the test, will be described and illustrated with photographs. The report will include a complete and detailed description of the test articles and sorties flown. Along with any recommendations that could correct any discrepancies identified [5].

#### 5.3.5.2 Structural Integrity Test Reports

Same reporting contents should be presented as given in Section 5.3.5.1 [5].

### 5.3.5.3 Endurance Test Reports

Same reporting contents should be presented as given in Section 5.3.5.1 [5].

## 5.3.6 Employment Tests Reports

### 5.3.6.1 Release Test Reports

Results of release tests should be included in whatever report is provided on the overall certification effort. All release test conditions, aircraft configurations, store, mass properties, reduced data and pilot comments should be formally documented in some form. Whether any or all of these data are provided to the certification agency is up to the specific agencies involved. If the separation tests resulted in information of general technical interest, then a technical report should be prepared. Distribution of this report would be to agencies outside the normal certification channels. Where unusual or complicated separation motion occurred, that should be depicted photographically or through sketches rather than by long, wordy, narratives [5].

### 5.3.7 Jettison Test Reports

Same reporting contents should be presented as given in Section 5.3.6.1 [5].

## 5.3.8 Ballistic Tests Reports

### 5.3.8.1 Weapon Free Stream Ballistics Test Reports

#### 5.3.8.1.1 General

Results of the analysis of the test data will be reported as requested by the certifying agency responsible for the aircraft.

#### 5.3.8.1.2 Ballistics Data Reduction

All ballistic data should be reduced as follows:

- a) Cine theodolite and radar data:
  - 1) Printouts in accordance with the appropriate programs, either uncorrected or corrected, for atmospheric conditions. The following data (title page and data format and parameters) are to be obtained from computer programs:
    - a) Time phasing and printout intervals:
      - 1) For the aircraft, from three seconds prior to release to two seconds after release (extrapolated from the available TSPI data); or, when aircraft/ munition separation data are required, from the radar TSPI to the times of impact, fuze function, cluster opening, or similar events.
      - 2) For the munition, from release to dispenser function, impact, or similar event.
      - 3) Printouts will be at 0.2 second intervals or at other intervals as mutually agreed on by the test project officer and analyst and at specified special event times.
    - b) Format (see Table 5-1 for definitions):
      - 1) Title page should be in accordance with Table 5-2.
      - 2) Data. Printouts should be in accordance with Table 5-3.

- II) In the reduction of smoothed data:
- a) The line of flight (direction of the downrange axis) will be the aircraft track at 0.0 time.
  - b) The origin of the co-ordinate system will be the target. If the origin must be something other than the target, it must be mutually agreed on by the test project officer, range personnel, and, most importantly, the analyst.
- b) Munitions event identification. These events may be recorded by cine theodolites, medium and high-speed cameras, recorders installed in the munitions, transmitted to a ground telemetry station from telemetry transmitters installed in the munitions, or similar instrumentations. Examples of these events are fin opening, control surface operations (up, down), cluster or chute start and complete opening, and fuze arm and function, as specified and as available from the data. The TSPI printouts will be annotated to indicate such events on request.
- c) CZR-1 and Milliken camera data. Sub-munitions impact velocities and angles and times of individual impacts (correlated to scored impact if possible) will be transmitted to the analyst.
- d) Impact data:
- I) For all munitions:
    - a) Plots of impact data, specifying the location of each munition (or sub-munition) of each release. For sub-munitions, these plots should be the initial and final impact patterns and each item will be identified by dispenser or cluster, and type. Annotate these plots with the line of flight, the release point, and other parameters, and/or information as requested by the test project officer or analyst.
    - b) Tabulate the locations of each munition or sub-munition with respect to the established co-ordinate system. For sub-munitions, each item will be identified by dispenser or cluster and type.
  - II) For sub-munitions, compute impact pattern statistical data (MPI, CEP, 80% or 90% ellipses, Sigma X, Sigma Y) and similar parameters as requested by analyst.

**Table 5-1: Ballistic Data Definitions [5].**

NAME	UNITS	PARAMETER – EQUATION (IF APPLICABLE)
TIME	H M S	TIME OF DAY IN HOURS, MINUTES, SECONDS
T-FREZ	SEC	TIME FROM FREEZE IN SECONDS
X, Y, Z	FEET	X CO-ORDINATE (X IS HORIZ ALONG FLT LINE); Y IS VERTICAL, + UP; Z IS HORIZ 90 DEG CLOCKWISE FROM +X) FOR THE NAVY: Y IS HORIZ AND Z IS UP
HT	FEET	HEIGHT ABOVE SEA LEVEL
SR	FEET	SLANT RANGE = $\text{SQRT}(X^{**2} + Y^{**2} + Z^{**2})$
GR RNG	FEET	GROUND RANGE = $\text{SQRT}(X^{**2} + Z^{**2})$
D PP	FEET	DISTANCE IN PROBLEM PLANE = $\text{SQRT}(X^{**2} + Y^{**2})$
RN, RE	FEET	RANGE NORTH; RANGE EAST
LAT, LONG	DMS	LATITUDE AND LONGITUDE IN DEGREES, MINUTES, SECONDS
VX	F/S	X VELOCITY – DIRECTION OF A/C
VY	F/S	Y VELOCITY – VERTICAL UP POSITIVE
VZ	F/S	Z VELOCITY – CROSS CLOCKWISE FROM X



NAME	UNITS	PARAMETER – EQUATION (IF APPLICABLE)
VN, VE	F/S	NORTHWARD AND EASTWARD VELOCITY COMPONENTS
VT	F/S	TOTAL VELOCITY = $\text{SQRT}(VX^{**2} + VY^{**2} + VZ^{**2})$
VA	F/S	TOTAL VELOCITY IN AIR MASS = $\text{SQRT}(VWX^{**2} + VY^{**2} + WZ^{**2})$
VG	F/S	GROUND VELOCITY = $\text{SQRT}(VX^{**2} + VZ^{**2})$
VWX	F/S	X VELOCITY WITH RESPECT TO AIR MASS = $VX - WX$
VWZ	F/S	Z VELOCITY WITH RESPECT TO AIR MASS = $VZ - WZ$
M	–	MACH NUMBER = $VAVS$
AX, AY, AZ	F/S/S	X, Y, AND Z ACCELERATION
A	F/S/S	ACCEL MAGNITUDE = $\text{SQRT}(AX^{**2} + AY^{**2} + AZ^{**2})$
LOCALG	F/S/S	VALUE OF GRAVITY FOR EACH SPECIFIC LOCATION
A	G	ACCEL MAGNITUDE = $AM / (\text{LOCALG} / (1 + HT/RAD)^{**2})$
AN G	G	NORMAL ACCEL = $\text{SQRT}(VY*AX - VWZ*(AY + G)^{**2} + (AX*VWZ - AZ*VWX)^{**2} + (VWX*(AY+G) - VY*AX)^{**2}) / (\text{LOCALG}*VA)$
AD	F/S/S	ACCEL DUE TO DRAG = $(AX*VWX + (AY + G)*VY + AZ*VWZ) / VA$
CD	–	DRAG COEFFICIENT = $-4AD / (\text{PI} * Q * \text{GAMMA} * G)$
WX, WZ	F/S	WIND VELOCITY (X AND Z COMPONENT)
P	I	N HG PRESSURE (INCHES MERCURY) = $.029536 * P$ (MILLIBARS)
VS	F/S	SPEED OF SOUND = $1116.89 * \text{SORT}((T(C) + 273.16) / 288.16)$
Q	LB/FT2	DYNAMIC PRESSURE = $49.511 * P * M^{**2}$
HV	DEGREES	TRACK FROM NORTH = $\text{ARCTAN}(VZ/VX) + \text{FLT LINE}$ (0 TO 360)
HVA	DEGREES	HEADING FROM NORTH = $\text{ARCTAN}(VWZ/VWX) + \text{FLT LINE}$ (0 TO 360)
DA GR	DEGREES	DIVE ANGLE = $\text{ARCTAN}(VY/VG)$ (-180 TO +180)
DA AIR	DEGREES	DIVE ANGLE = $\text{ARCTAN}(VY/\text{SQRT}(VWX^{**2} + VWZ^{**2}))$ (-180 TO +180)
KD	–	DRAG COEFFICIENT (BALLISTICS) = $.3927 * CD$
POS ER	FEET	ERROR IN POSITION DUE TO NOISE
GAMMA	FT2/LB	$(\text{WEAPON DIAMETER})^{**2} / \text{WEAPON WEIGHT}$
XA, YA, ZA	FEET	AIRCRAFT X, Y, AND Z CO-ORDINATE OFFSET FROM FILM READING CO-ORDINATES TO SOME OTHER AIRCRAFT REFERENCE POINT
ANGLE OF ROTATION	DEGREES	AXIS TO A/C TRACK AT WEAPON RELEASE IN GROUND PLANE
NO PT SMO	–	NUMBER OF POINTS USED IN SMOOTHING ROUTINE
DEG	–	DEGREE OF POLYNOMIAL THAT TSPI DATA IS SMOOTHED TO
DOWN RANGE MISS DIST	FT	DIFFERENCE BETWEEN AIMPOINT (AT DESIGNATED REF TO TGT) AND WEAPON IMPACT (REF TO TGT) IN ALONG TRACK
CROSS-RANGE MISS DIST	FT	DIFFERENCE BETWEEN AIMPOINT AND WEAPON GROUND IMPACT IN THE CROSS RACK CO-ORDINATES

**Table 5-2: Ballistic Data Title Page Format [5].**

Line 1: TEST NO. DATE MSN NO. PASS NO. A/C/ITEM A/C TYPE/TAIL NO.
Line 2: BLANK
Line 3: ID NO PT SMO DEG
Line 4: INPUT ORIGIN LAT LONG HT FLT LINE
Line 5: XA YA ZA ANGLE OF ROTATION
Line 6: OUTPUT LAT LONG HT FLT LINE
Line 7: T-ZERO SOURCE OF T-ZERO (i.e. aircraft UHF tone, medium speed (96 fps) cameras, cinetheodolites, or aircraft rack instrumentation)
Line 8: GAMMA

**Table 5-3: Ballistic Data Printout Format [5].**

PAGE 1	ZULU TIME T-FREZ X Y Z VX VY VZ HT
PAGE 2	T-FREZ VT VA VWX VWZ WX WZ HT POSER
PAGE 3	T-FREZ AN G AD M KD CD DA GR DA AIR HT
PAGE 4	T-FREZ AX AY AZ HV HVA Q HT SR
PAGE 5	DOWN RANGE MISS DISTANCE CROSS-RANGE MISS DISTANCE MPI STANDARD DEVIATION CEP

### 5.3.8.2 OFP Ballistic Test Reports

#### 5.3.8.2.1 General

Results of the analysis of the test data will be reported as requested by the certifying agency responsible for the aircraft. If the certifying agency requests aim point offsets be supplied for specific delivery conditions then the report should clearly define and show exactly the sign conventions used.

#### 5.3.8.2.2 Ballistics Data Reduction

As specified in Section 5.3.8.4 with the data shown in Table 5-4.

**Table 5-4: Data for OFP Ballistic Evaluation and Verification Tests [5].**

DOWN RANGE MISS DISTANCE
CROSS-RANGE MISS DISTANCE
AIRCRAFT RELEASE CONDITIONS: ALTITUDE (AGL AND MSL) AIRSPEED AND MACH NUMBER FLIGHT PATH ANGLE SLANT RANGE TO TARGET PILOTS AIMPOINT AT DESIGNATION RELATIVE TO TARGET G's (LOAD FACTOR) ANGLE OF ATTACK (OR EQUIVALENT) HEADING (MAGNETIC AND TRUE)

### 5.3.8.3 Separation Effects Test Reports

As specified in Section 5.3.8.1 the report should also specify the number of weapon releases used to statistically determine coefficients and range bias/aim point offsets.

### 5.3.8.4 OFP Ballistic Verification Test Reports

As specified in Section 5.3.8.2 [5].



## Chapter 6 – SHIPBOARD CARRIER SUITABILITY TESTING/REPORTING

### 6.1 INTRODUCTION

Although carrier suitability testing includes ground and flight testing both, for this document, it is given under this section instead of relative Sections 4.4.2 and 4.4.3.

Military aircraft in naval service have a unique requirement to take-off and land aboard ship while carrying a wide variety of stores and weapon systems. Some highly specific flight testing processes are employed to ensure these stores and weapons do not pose any threat to the host aircraft and retain full functionality before they are cleared to operate in a shipboard environment.

The weapon itself must successfully undergo a series of qualification tests including electro-magnetic interference and vulnerability, corrosion resistance, and static structural loading prior to being considered for an on-aircraft shipboard suitability evaluation. Those qualification tests will vary with weapon type and shipboard usage and are typically not the subject of a flight test program. A flight test program itself will normally focus on dynamic structural loads and shock imposed by the highly dynamic environment of taking off from a ship, often using a catapult, and landing back aboard, often into an arresting gear.

It is typically assumed that any weapon system or store considered for shipboard suitability testing has already completed captive carriage and aircraft interface compatibility tests, including electro-magnetic compatibility, with the host aircraft. As such, Carrier Suitability Testing (CVS) is often performed later in a weapon integration evaluation when problems found may prove difficult to resolve without adverse programmatic impact. For this reason, as well as due to the inherently hazardous nature of CVS envelope expansion tests, it is imperative to be fully prepared for CVS testing and to thoroughly document test results.

Fixed wing aircraft undergo longitudinal accelerations in excess of +5g during catapult launches and -4 g during decelerations; accelerations that impose high stresses on bomb racks and store mounting hardware. Coupled to these accelerations, stores are also subject to tremendous vertical forces during maximum sink rate arrested landings that can exceed 20 feet per second descent rates. These major forces are in addition to any imparted by host aircraft wing bending modes or the additional contribution of roll, yaw, or pitch rates present at the time of arrestment. All things considered, a shipboard operational envelope for fixed wing aircraft may pose the most extensive set of structural forces on a weapon or store of any other operation aside from actual weapon employment.

Four major questions are addressed during a dedicated CVS flight test event:

- 1) Structural integrity of the store or weapon (does it stay together?)
- 2) Functional survivability of the store or weapon after a launch and recovery (will it work?)
- 3) System integrity of any arming circuits or arming wires (did they stay properly connected?)
- 4) Flying qualities or performance impact on the host aircraft (can it still fly?)

Special instrumented test variants of the weapons are usually developed as engineering test vehicles without live warheads to evaluate structural loads, system functionality, flying qualities and performance, and captive carry characteristics. It is typically a good practice to employ as fully functional a store or weapon during CVS testing that can safely be subjected to the tests. These functional CVS tests are usually conducted later in the test program where a more mature system is available to test. Often active guidance and control sections, seeker heads, datalinks, GPS, fuzes, and rocket motors are used for CVS tests and their

functionality ascertained after each launch or recovery event through either Built-In Tests (BIT) or ground testing. Inert test weapons that are used for CVS testing can be converted to live weapons and are often dropped on test ranges after the completion of the CVS events as a final proof of their system viability.

Similarly, aviation ordnancemen and flight test engineers check stores and weapons for arming wire retention, structural security, and general physical survival after each catapult launch or arrested landing during a CVS test session. This physical inspection is as important as active monitoring of flight and structural instrumentation parameters to determine the suitability of advancing to the next test point or labeling a test event as successfully completed.

Each type of aircraft will subject stores or weapons to a somewhat different set of forces during CVS testing depending upon mounting configurations and aircraft structural dynamics. For a weapon that will be employed on multiple types of naval aircraft, it is considered a best practice to qualify the store for shipboard operations on the aircraft that poses the worst case structural conditions and then clearing the other aircraft by analysis. If a weapon or store will only be fielded on a single type of naval aircraft, then the decision should be to test on that aircraft only and provide the largest operating envelope possible for that single application.

The US Navy maintains shore-based catapults and arresting gear in order to support flight testing and development of launch and recovery equipment. The inherent dangers and difficulty of conducting catapult launch and arrested landing tests preclude conducting these tests at sea. These test sites allow for improved risk management of CVS test programs by testing to limit conditions in a more controlled environment, having extensive instrumentation capabilities available, easy aircraft accessibility, and a wealth of knowledge across the aircraft/weapons system within easy reach. Not to mention the obvious difficulties associated with obtaining available flight deck time on an extremely busy aircraft carrier. The store/weapon catapult launch and arrested landing envelope, limitations, operating procedures, etc., are established during these shore-based tests. This allows shipboard operational testing or deployment to be conducted by operational testers or fleet users [91].

## **6.2 BASIC CVS CATAPULT LAUNCH AND ARRESTED LANDING TESTS**

The MIL-D-8708C General Specification for Demonstration: Aircraft Weapon Systems, Section 3.6 contains both catapult launch and arrested landing conditions to which an airframe must be tested or demonstrated. These conditions are derived from launch and landing envelopes for an aircraft type based on applicable MIL-A-8860 series specifications on strength, rigidity, and loads. From the set of test events contained in the -8708C, a tailored set of catapult launch and arrested landing tests are conducted to meet the requirements of the specific aircraft under test with any store or weapon carried on that aircraft.

A typical catapult launch matrix of tests and test conditions will include several buildup catapult launches with progressively higher longitudinal accelerations and faster end speeds until reaching the maximum acceleration demonstration point (Table 6-1). Additional catapult launches are made at high offset angles where the test aircraft is not aligned directly with the catapult track resulting in lateral acceleration upon launch in order to pull the aircraft into alignment with the launch track. A normal buildup sequence can typically be accomplished in six catapult launches.



**Table 6-1: Typical Catapult Launch Matrix.**

Event	Type	Nominal N <sub>x</sub> (g)	Power Setting	Comments
1	Buildup	4.0	MIL	On center
2	Buildup	4.5	MIL	On center
3	Buildup	5.0	MIL	24 inches off-center left <sup>(1)</sup>
4	Max. g	5.5 (at least 5.3 g required)	MIL / MAX <sup>(2)</sup>	On center
5	Max. g	5.5 (at least 5.3 g required)	MIL / MAX <sup>(2)</sup>	24 inches off-center left <sup>(1)</sup>
6	Max. g	5.5 (at least 5.3 g required)	MIL / MAX <sup>(2)</sup>	24 inches off-center right <sup>(1)</sup>

- Notes:
- (1) Off-center distance measured at the main gear tire tread center relative to the catapult centerline with the aircraft launch bar on top of the shuttle. The off-center distance is the difference between the measured distance and half the main gear span.
  - (2) MAX is defined as maximum afterburner in aircraft so equipped.

This catapult matrix is for weapons where longitudinal acceleration on the catapult is the critical condition, which is typical of wing-mounted stores. There may be instances where the tow force itself (measured by launch bar axial load) may establish the critical or worst case condition. In this case increases in catapult longitudinal acceleration (N<sub>x</sub>) and aircraft gross weight would be used to buildup the launch bar axial load to the calculated tow force limit. In either case, these tests establish the catapult launch envelope and limitations (if any) for the test store/weapon such that they remain fully functional throughout the life of the store/weapons.

It is important to note that established aircraft limitations such as catapult launch crosswind, excess end airspeed, tow force, or maximum gross weight must be adhered to as well as limitations for the catapult itself throughout any weapon or store CVS test and may override higher targeted test points or dictate certain test conditions required to meet the test launch conditions.

Similar to the aforementioned catapult launch test sequence, arrested landing tests exposes the test aircraft and stores to the high loads that may be experienced during at-sea operation of the weapon system. These test events are often more demanding and more difficult to control than the catapult launches as the aircraft approaches each one from an in-flight set of conditions rather than from a static ground state.

The arrested landing phase of CVS testing consists of maximum sink rate landings, maximum deceleration/high-speed engagement arrestments, roll/yaw attitude engagements, off-center engagements, and free-flight engagements. These tests establish the arrested landing envelope and limitations (if any) for the test store/weapon such that they remain fully functional throughout the life of the store/weapons.

Gradual increases in glideslope approach angles are a vital test technique to achieve a controlled buildup in touchdown sink rate so as to achieve the targeted endpoint without overstressing the aircraft by exceeding the structural limits established for that airframe. After the initial arrestment, some buildup approaches may be flown to a touch-and-go instead of an actual arrested landing to conserve test resources and minimize test time while still obtaining the desired buildup in sink rate. At some point in the test buildup, typically when within 20% of the targeted sink rate end point, full arrestments must be made. These buildups can be very time consuming and may extend the test period beyond the projected 13 test points listed in Table 6-2 as the test pilot works to establish each new glideslope and its associated higher sink rate. Additionally, pilot technique can greatly affect the success of roll/yaw, off-center, and free-flight engagements and these test points often require multiple attempts in order to achieve targeted test values.

**Table 6-2: Typical Arrested Landing Test Matrix.**

Event	Type	Nominal Sink Speed (fps)	Nominal N <sub>x</sub> (g)	Comments
1	Nominal	13	As required	<ul style="list-style-type: none"> <li>~3.5° glideslope.</li> </ul>
2	Buildup High Sink (T/G <sup>(1)</sup> )	15	As required	<ul style="list-style-type: none"> <li>Glideslope adjusted to attain target sink speed.</li> <li>An arrested landing is required for each event when the target sink speed is within 2 fps of the test limit or the glideslope &gt; 5.0°.</li> </ul>
3	Buildup High Sink (T/G)	17	As required	
4	Buildup High Sink	19	As required	
5	Buildup High Sink	20	As required	
6	High Sink	21	As required	
7	Free Flight	Less than 9.5	As required	<ul style="list-style-type: none"> <li>Glideslope adjusted to attain sink speed.</li> <li>Wire engagement prior to main gear touchdown while in a rate of descent.</li> </ul>
8	Roll / Yaw Opposite Left Wing Down	As required	As required	<ul style="list-style-type: none"> <li>3.5° or 4.0° glideslope.</li> <li>≤ -5° roll required.</li> <li>≥ 5° yaw desired.</li> </ul>
9	Roll / Yaw Opposite Right Wing Down	As required	As required	<ul style="list-style-type: none"> <li>3.5° or 4.0° glideslope.</li> <li>≥ 5° roll required.</li> <li>≤ -5° yaw desired.</li> </ul>
10	Buildup Max N <sub>x</sub> <sup>(2)</sup>	As required	-3.5	<ul style="list-style-type: none"> <li>3.5° or 4.0° glideslope.</li> <li>Flaps and/or AOA may be adjusted so as to attain engagement speed needed for target acceleration.</li> </ul>
11	Max N <sub>x</sub> On Center <sup>(2)</sup>	As required	-4.0	<ul style="list-style-type: none"> <li>3.5° or 4.0° glideslope.</li> <li>≤ -3.8 g required.</li> </ul>
12	Max N <sub>x</sub> Off Center <sup>(2)</sup>	As required	-4.0	<ul style="list-style-type: none"> <li>3.5° or 4.0° glideslope.</li> <li>≤ -3.8 g required.</li> <li>Target 18 ft. off centerline port.</li> <li>≥ 17 ft. off-center required.</li> </ul>
13	Max N <sub>x</sub> Off Center <sup>(2)</sup>	As required	-4.0	<ul style="list-style-type: none"> <li>3.5° or 4.0° glideslope.</li> <li>≤ -3.8 g required.</li> <li>Target 18 ft. off centerline, starboard.</li> <li>≥ 17 ft. off-center required.</li> </ul>

Notes: (1) T/G is Touch-and-Go landing.  
 (2) Target engaging speed will be adjusted to remain within arresting gear capacity and aircraft limits.

Site instrumentation systems typically require that, prior to the first arrestment on each flight, a low approach to the landing area be flown to verify engagement speed data sources. Once the engagement speed checks are

completed, a nominal  $3.5^\circ$  lens setting arrestment will be conducted followed by buildup to the targeted test points. Aircraft gross weight, aircraft flap setting, aircraft approach AOA, lens angle, and lens position can be adjusted throughout the test sequence in order to obtain the desired landing conditions. It is important to limit changes in approach glideslope to  $0.25^\circ$  or  $0.5^\circ$  increments, as necessary, until maximum sink rate landing is obtained to maintain a measured buildup process.

As stated for the catapult launch testing, and potentially even more important in the highly dynamic arrested landing process, established aircraft limitations affecting Angle-Of-Attack (AOA), flap settings, and arrested landing limits including sink speed, tailhook load, or maximum deceleration ( $-N_x$ ) must be adhered to throughout all tests as must limitations for the arresting gear itself. These conditions may force restrictions on acceptable test day weather conditions, force testing to be delayed to a more suitable day, or dictate test point sequence.

From a test integrity and safety standpoint, it is imperative that any ordnance technicians or engineers tasked with inspecting the security of store components as well as arming wires and electrical connectors after each event be fully trained on aircraft and shipboard procedures to ensure they do not get close to any jet blast areas or propeller arcs in their haste to inspect the stores. Thorough safety briefs attended by all personnel are a requirement for any CVS testing given the close access to running aircraft required to prosecute these tests.

Final test success is verified by successful store functional tests, maintenance of acceptable aircraft flying qualities and performance throughout the CVS test envelope, continued structural integrity of the store or weapon and its associated arming wires and wiring, and validation of instrumented test parameters such as sink rates, engagement speeds, accelerations, and loads to ensure aircraft end points were met [91].



## Chapter 7 – FUTURE DEVELOPMENTS

### 7.1 WEAPONIZATION OF UNMANNED AIR SYSTEMS

Weaponization of UAS is becoming reality. While the “no single failure” principles are still very much applicable, the removal of the pilot from the aircraft brings new challenges for the safe integration of weapons.

UAS are also driving the need for even smaller weapons (in the sub 3 kg class), and for these, new interfaces are required. Also, future weapons may not depend on kinetic kill. The development of weapons employing high-powered lasers and microwaves is being investigated and one system, the US Airborne Laser Program, is in advanced development.

While these new weapon types bring new challenges for the weapons integrator, the basic principles for safe, available systems that can deliver a military effect with high precision still hold true.

### 7.2 UNIVERSAL ARMAMENTS INTERFACE

MIL-STD-1760 [9] (STANAG 3837) defines a standardized discrete signals, connector, pin out, message-data formats but logical interface requirements are limited to 3 standardized messages (1R/1T, 11R/T, 14R/T) and remaining messages are defined up to each individual store. Each store has its own unique logical interface requirements and its own interface control document. Mission planning interfaces or launch acceptability region algorithms has no defined standards.

That type of “non-standardized” approach results in non-recurring integration costs and long deployment times (Table 7-1). Aircraft-weapon software integration effort may cost in between \$20M – \$120M and it may take up to 8 – 12 years to fully field new Precision-Guided Munitions (PGM) class weapons on the combat aircraft fleet. Therefore, a “universal” integration capability is sought. The Universal Armament Interface (UAI) is the most prominent solution that addresses this challenge.

**Table 7-1: Key Cost Drivers in Store Integration.**

	Min %	Av %	Max %
Functional Validation	11	20	30
Separation	7	14	26
Functional Definition and Development	7	12	27
Weapon Carriage Trials	3	11	15
System Safety	5	11	14
Interface Definition	4	8	12
Aero Mechanical	4	8	12
Wpn Sys Integration Requirements	1	5	18
Airworthiness/ Certification	0.4	4	6
Electromagnetic Compatibility	2	4	5
Weapon System Evaluation	1	3	14

UAI is a US Department of Defense initiative to develop standardized functional interfaces in aircraft, weapons and mission planning to support integration of future weapons independent of aircraft OFP cycles. UAI is a system of interfaces, tools and processes working together to produce a capability.

In the UAI concept, a Configuration Data Set (CDS) is uploaded into the aircraft storage system for each weapon using a data transfer device. In addition, aircraft and weapon mission data and GPS initialization data may be transferred. The CDS comprises various UAI Configuration Data Files (CDF) that contain interface definition data and LAR coefficients. The CDS is created through a combination of aircraft/stores integration activities. A UAI compliant Joint Mission Planning System (JMPS) is responsible for final compilation of the mission data set and CDFs that are uploaded to the data transfer device (Figure 7-1).

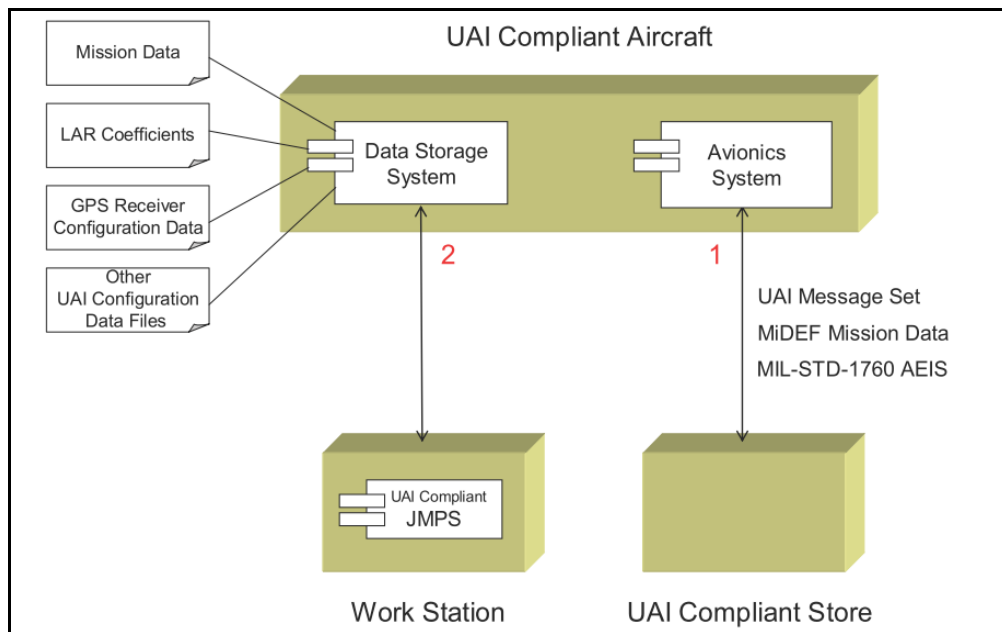

**Figure 7-1: UAI System Interface Description.**

The aircraft/stores interface is based on the MIL-STD-1760 [9] AEIS. The full message set is defined by the UAI platform/store ICD, which supports the transfer of weapon mission data using the MIL-STD-3014 Mission Data Exchange Format (MiDEF) standard.

UAI, in its current stage, supports air-to-ground direct attack, waypoint, and loitering weapons and some sensor pod capabilities. Smart obedient racks, in which all functions controlled by aircraft for up to 8 stations and smart independent racks, which require a CDS file to configure the carriage system are the two UAI supported types of carriage systems.

UAI require standardized software interfaces in platforms, stores and mission planning systems. To meet the objective of decoupling platform Operational Flight Program (OFP) update cycles from the store integration process require the below working areas:

- Platform/store interface through the MIL-STD-1760 interfaces;
- Store Unique Planning Component (UPC) to Platform UPC interface within the Joint Mission Planning System (JMPS);
- Display and entry of store critical data by the aircrew; and
- Launch Acceptability Region (LAR) algorithm capabilities and reprogrammable coefficient tables.



**UAI Compliant LAR:** LAR for smart munitions can be defined as a region where the target will be successfully reached if the weapon is released within this region. There is a flexibility of choosing different release points within a zone for guided munitions by reshaping their trajectories during flight, but this is not the case for the unguided weapons because of their ballistic trajectories. Similar to the ballistic algorithms that computes release points for un-guided weapons, launch acceptable region algorithm are being developed for guided weapons. Using the non-parametric regression methods is one of the approaches for calculation of launch acceptable region using the data sets obtained from simulation results. UAI-compliant LAR should be standardized to support the LAR requirement above. In order to compensate for reprogrammable coefficient tables (see LAR requirement above, related process shown in Figure 7-2), the non-parametric regression methods MARS or PPR has been utilized by weapon suppliers.

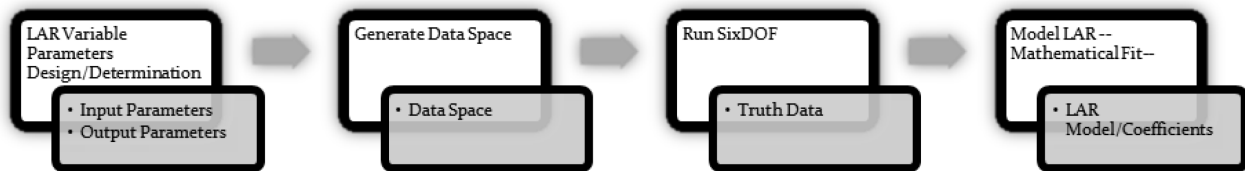

Figure 7-2: Simple UAI Compliant LAR Database Generation Procedure.



## Chapter 8 – REFERENCES

- [1] NAVPERS-10798-A, “Naval Ordnance and Gunnery”, 1955.
- [2] Arnold, R.J., Epstein, C.S. and Bogue, R.K., “Store Separation Flight Testing”, AGARD-AG-300-Vol-5, 1986.
- [3] Wuest, M.R. and Beney, R.J., “Precision Airdrop”, RTO-AG-300-Vol-24, 2005.
- [4] MIL-HDBK-244A, “Guide to Aircraft Stores Compatibility”, 1990.
- [5] MIL-HDBK-1763, “Aircraft/Stores Compatibility: Systems Engineering Data Requirements and Test Procedures”, 1998.
- [6] McShea, R.E., “Test and Evaluation of Aircraft Avionics and Weapon Systems”, SciTech Publishing Incorporated, 2010.
- [7] STANAG 4187, “Fuzing Systems – Safety Design Requirements”, 2007.
- [8] STANAG 3726, “Bail (Portal) Lugs for the Suspension of Aircraft Stores”, 1996.
- [9] MIL-STD-1760, “Aircraft/Store Electrical Interconnection System”, 2007.
- [10] Fleeman, E.L., “Tactical Missile Design”, American Institute of Aeronautics and Astronautics, 2006.
- [11] MIL-STD-704, “Aircraft Electric Power Characteristics”, 2013.
- [12] MIL-STD-1553, “Digital Time Division Command/Response Multiplex Data Bus”, 1996.
- [13] GlobalSecurity.org, “Airborne Armament Equipment (AAE)”, 17 February 2014, <http://www.globalsecurity.org/military/systems/aircraft/systems/aae.htm>.
- [14] NAVEDTRA 14014A, “Airman”, 2012.
- [15] MIL-STD-2088, “Bomb Rack Unit (BRU), Single Store, Aircraft”, 2012.
- [16] Cobham Mission Equipment, “PBER Pneumatic Bomb Ejection Rack” 17 February 2014, <http://www.cobham.com/media/58988/pber-900-069-0209.pdf>.
- [17] Cobham Mission Equipment, “BRU-61/A Small Diameter Bomb Carriage System”, 17 February 2014, <http://www.cobham.com/media/58974/bru-61a-900-071-0209.pdf>.
- [18] Rigby, K.A., “Aircraft Systems Integration of Air Launched Weapons”, Chichester, John Wiley & Sons Ltd., 2013.
- [19] Wikipedia media file, “JDAM\_GBU30\_MER.jpg”, 17 February 2014, [http://upload.wikimedia.org/wikipedia/commons/5/5c/JDAM\\_GBU30\\_MER.jpg](http://upload.wikimedia.org/wikipedia/commons/5/5c/JDAM_GBU30_MER.jpg).
- [20] Wikipedia media file, “BRU-61%2B4xGBU-39.jpg”, 17 February 2014, <http://upload.wikimedia.org/wikipedia/commons/d/de/BRU-61%2B4xGBU-39.jpg>.

## REFERENCES

---

- [21] EIA Standard IS-632, Systems Engineering, 1994.
- [22] IEEE P1220, “Standard for Application and Management of the Systems Engineering Process”, 1994.
- [23] Ryen, E., “Overview of the System Engineering Process”, North Dakota Department of Transportation”, 2008.
- [24] INCOSE, “Systems Engineering Handbook, Version 2a”, 2004, p. 11.
- [25] Ramo, S., “Systems Engineering Manual”, Federal Aviation Agency.
- [26] Eisner, H., “Essentials of Project and Systems Engineering Management”, John Wiley & Sons Ltd., 2011.
- [27] Rechtin, E., “Systems Architecting of Organizations: Why Eagles Can’t Swim”, CRC Press, 1999.
- [28] NASA/SP-2007-6105, “Systems Engineering Handbook”, 2007.
- [29] Kossiakoff, A., Sweet, W.N., Seymour, S.J. and Biemer, S.M., “Systems Engineering Principles and Practice”, John Wiley & Sons, Inc. Publications, 2011.
- [30] “System Engineering Fundamentals”, Supplementary Text prepared by the Defense Acquisition University Press Fort Belvoir, VA, USA, 2001.
- [31] MIL-STD-499B (Draft), “Systems Engineering”, 1994.
- [32] Boehm, B.W., “Software Engineering, IEEE Transactions on Computers”, C-25, pp. 1226-1241, 1976.
- [33] Shamieh, C., “Systems Engineering for Dummies”, IBM Limited Edition, Wiley Publishing, Inc. 2011.
- [34] Boehm, B.W., “A Spiral Model of Software Development, and Enhancement”, Computer, (21,5) pp. 61-88, 1988.
- [35] MIL-E-7016F, “Electric Load and Power Source Capacity, Aircraft, Analysis of”, 1988.
- [36] MIL-STD-810G, “Environmental Engineering Considerations and Laboratory Tests”, 2008.
- [37] MSFC-HDBK-3173, “Project Management and System Engineering Handbook”, NASA, 2001.
- [38] Boehm, B., “A Pioneer of Software Engineering”, 1979.
- [39] RTCA/DO-178B, “Software Considerations in Airborne Systems and Equipment Certification”, 1992.
- [40] Nautilus Workshop, “Introduction to Avionic Systems Development”, 10 February 2013, [www.nautiluspace.com](http://www.nautiluspace.com).
- [41] Meyer, R., Cenko, A. and Yaros, S., “An Influence Function Method for Predicting Aerodynamic Characteristics During Weapon Separation”, 12th Navy Symposium on Aeroballistics, 1981.
- [42] Magnus, A.E. and Epton, M.A., “PAN AIR – A Computer Program for Predicting Subsonic or Supersonic Linear Potential Flows About Arbitrary Configurations Using a Higher Order Panel Method”, NASA CR-3251, 1980.

- [43] MIL-HDBK-310, “Global Climatic Data for Developing Military Products”, 1997.
- [44] STANAG 2895, “Extreme Climatic Conditions and Derived Conditions for Use in Defining Design/ Test Criteria for NATO Forces Materiel”, 1990.
- [45] Böswald, M., Göge, D., Füllekrug, U. and Govers, Y., “A Review of Experimental Modal Analysis Methods with Respect to their Applicability to Test Data of Large Aircraft Structures”, Proceedings of the ISMA, 2006.
- [46] Peeters, B., Climent, H., Diego, R., Alba, J., Ahlquist, J.R., Carreño, J.M., Hendricx, J.M., Rega, A., García, G., Deweer, J. and Debille, J., “Modern Solutions for Ground Vibration Testing of Large Aircraft”, Proceedings of 26<sup>th</sup> IMAC, 2008.
- [47] Peeters, B., De Baets, P., Mosenich, L., Vecchio, A. and Van der Auweraer, H., “ Ground Vibration Testing in the Aeroelastic Design and Certification of a Small Composite Aircraft”, 46<sup>th</sup> AIAA/ASME/ ASCE/AHS/ASC Structures, Structural Dynamics and Materials Conference, 2005.
- [48] MIL-STD-8591, “Airborne Stores, Suspension Equipment and Aircraft-Store Interface (Carriage Phase)”, 2012.
- [49] MIL-STD-1289D1, “Airborne Stores Ground Fit and Compatibility, Requirements”, 2004.
- [50] Bono, R., “Transducer Mounting and Test Setup Configurations”, 26th International Modal Analysis Conference, 2008.
- [51] MeggittEndevco Corp., “Guide to Adhesively Mounting Accelerometers”, 17 February 2014, <https://www.endevco.com/wp-content/uploads/TP312.pdf>.
- [52] “Shaker Excitation Tutorial Considerations and Problems”, Structural Dynamics Research Laboratory, University of Cincinnati, USA, 2001.
- [53] Stoliker, F.N. “Introduction to Flight Test Engineering”, Flight Test Techniques Series – Volume 14, AGARD AG-300-Vol-14, 1995.
- [54] Jenkins, D.R., “Space Shuttle: The History of the National Space Transportation System”, Voyageur Press, 2007.
- [55] Cox, T.H. and Gilyard, G.B., “Ground Vibration Test Results for Drones for Aerodynamic and Structural Testing (DAST) / Aeroelastic Research Wing (ARW-1R) Aircraft”, NASA Technical Memorandum, 1986.
- [56] Kehoe, M.W., “Modified US Army U-8F Ground Vibration Test”, NASA Technical Memorandum, 1986.
- [57] Kehoe, M.W. and Lawrence, C.F., “Aircraft Ground Vibration Testing at the NASA Dryden Flight Research Facility – 1993”, NASA Technical Memorandum, 1994.
- [58] Rider, C.D. and Muller, K.T., “Vibration Test on F/A-18 Aircraft Fitted with Loads Instrumentation”, DSTO Aeronautical and Maritime Research Laboratory Australia, 1996.
- [59] Gloth, G., “Use of Finite-Element Models for Preparation of Ground Vibration Test”, Aerospace Science and Technology, 5, 2001.

## REFERENCES

---

- [60] Versteede, K. and Vanhollebeke, F., “Analytical and Numerical Analysis of the Dynamic and Aeroelastic Behavior of a Composite Aircraft”, Aeronautics Days 2006 Conference – Sustainable Solutions for New Horizons in Vienna, 2006.
- [61] Lubrina, P. and Degener, M., “Modal Identification of Large Aircraft”, 1st ONERA-DLR Aerospace Symposium, 1999.
- [62] Fargette, P., Füllekrug, U., Gloth, G., Levadoux, B., Lubrina, B., Schaak, H. and Sinapius, M., “Tasks for Improvement in Ground Vibration Testing of Large Aircraft”, Proceedings of IFASD, 2001.
- [63] AFLC/AFSC Regulation 80-28, “The Aircraft/Stores Compatibility Program”, 10 March 1978.
- [64] Pauwels, S., Michel, J., Robijns, M., Peeters, B. and Debille, J., “A New MIMO Sine Testing Technique for Accelerated, High Quality FRF Measurements”, Proceedings of 24<sup>th</sup> IMAC, 2006.
- [65] Böswald, M., Govers, Y., Göge, D. and Zhang, L., “Identification of Modal Parameters of Aircraft during Taxi”, Proceedings of 26<sup>th</sup> IMAC, 2008.
- [66] Peeters, B., Troyer, T.D., Guillaume P. and Van der Auweraer, H., “In-Flight Modal Analysis – A Comparison Between Sweep and Turbulence Excitation”, Proceedings of the ISMA, 2006.
- [67] Peeters, B., Vecchio, A. and Van der Auweraer, H., “PolyMAX Modal Parameter Estimation from Operational Data”, Proceedings of the ISMA, 2004.
- [68] Peeters, B., Leurs, W., Van der Auweraer, H. and Deblauwe, F., “10 Years of Industrial Operational Modal Analysis: Evolution in Technology and Applications”, Proceedings of the IOMAC Workshop, 2006.
- [69] Pickrel, C.R., “Airplane Ground Vibration Testing – Correlation with Nominal Modal Model”, Proceedings of 20<sup>th</sup> IMAC, 2002.
- [70] Chang, C.S. and Hodges, D.H., “Parametric Studies on Ground Vibration Test Modeling for Highly Flexible Aircraft”, Journal of Aircraft, V44, No. 6, 2004.
- [71] Goege, D., “Fast Identification and Characterization of Nonlinearities in Experimental Modal Analysis of Large Aircraft”, Journal of Aircraft, V44, No. 2, 2007.
- [72] Pauly, W., “Introduction to Vibration Testing”, 17 February 2014, <http://www.vibrationworld.com>.
- [73] Baker, R., “An Introduction to Vibration”, 17 February 2014, <http://www.vibkit.com>.
- [74] Harris, C.M. and Piersol, A.G., “Harris’ Shock and Vibration Handbook”, McGraw-Hill, 2002.
- [75] ADS-37A-RPF, “Aeronautical Design Standard: Electromagnetic Environmental Effects (E3) Performance and Verification Requirements”, 1996.
- [76] MIL-STD-461F, “Requirements for the Control of Electromagnetic Interference Characteristics of Subsystems and Equipment”, 2007.
- [77] MIL-STD-464C, “Electromagnetic Environmental Effects Requirements for Systems”, 2010.
- [78] MIL-HDBK-240, “Hazards of Electro Magnetic Radiation on Ordnance Test Guide”, 2011.



- [79] Adolph, C.E., “Planning of a Flight Test Program / Basic Principles of Flight Test Instrumentation Engineering”, AGARD-AG-160-Volume-1-Issue-2, 1994.
- [80] Karbancıoğlu, İ.M., Katırcı, A., Kutluay, Ü., Kafdağlı, K.E. and Ataç, S, “Application of Photogrammetric Methods for the Analysis of Safe Separation Analysis”, SAVTEK 2006, June 29-30, 2006, Ankara, Turkey.
- [81] MIL-A-8870C, “Airplane Strength and Rigidity, Vibration, Flutter, and Divergence”, 1993.
- [82] Wright, J.R., “Introduction to Flutter of Winged Aircraft: Flight Flutter Testing”, Lecture Series 1992-01, von Kármán Institute for Fluid Dynamics, Chaussée de Waterloo 72, B-1640 Rhode Saint Genèse, Belgium.
- [83] Nunen, J.W.G. van and Piazzoli, G., “Aeroelastic Flight Test Techniques and Instrumentation”, AGARD-AG-160-Volume-9, 1979.
- [84] Norton, W.J., Captain, USAF, “Random Air Turbulence as a Flutter Test Excitation Source”, Society of Flight Test Engineers 20th Annual Symposium Proceedings, 1989.
- [85] Norton, W.J., Captain, USAF, “Structures Flight Test Handbook”, AFFTC-TIH-90-001, 1990.
- [86] MIL-F-8785, “Flying Qualities of Piloted Airplanes”, 1980.
- [87] MIL-HDBK- 1797, “Flying Qualities of Piloted Aircraft”, 2006.
- [88] AIR-STD-20/21, “Airborne Stores Ground Fit and Compatibility Criteria”, 1999.
- [89] MIL-D-8708C, “Demonstration: Aircraft Weapon Systems”, General Specification for, 1991.
- [90] SD- 8706C, “Design Examinations, Engineering, Aircraft Weapons System”, 1986.
- [91] Trost, C. and Lowry, W., “Shipboard/Carrier Suitability Testing for Stores and Weapons”, US Naval Air Warfare Center, Patuxent River, MD, USA, 2013.

## REFERENCES

---



## **Annex A – AGARD and STO Flight Test Instrumentation and Flight Test Techniques Series**

### **1. Volumes in the AGARD and STO Flight Test Instrumentation Series, AGARDograph 160**

Volume Number	Title	Publication Date
1.	Basic Principles of Flight Test Instrumentation Engineering Issue 1: Edited by A. Pool and D. Bosman Issue 2: Edited by R. Borek and A. Pool	1974 1994
2.	In-Flight Temperature Measurements by F. Trenkle and M. Reinhardt	1973
3.	The Measurements of Fuel Flow by J.T. France	1972
4.	The Measurements of Engine Rotation Speed by M. Vedrunes	1973
5.	Magnetic Recording of Flight Test Data by G.E. Bennett	1974
6.	Open and Closed Loop Accelerometers by I. McLaren	1974
7.	Strain Gauge Measurements on Aircraft by E. Kottkamp, H. Wilhelm and D. Kohl	1976
8.	Linear and Angular Position Measurement of Aircraft Components by J.C. van der Linden and H.A. Mensink	1977
9.	Aeroelastic Flight Test Techniques and Instrumentation by J.W.G. van Nunen and G. Piazzoli	1979
10.	Helicopter Flight Test Instrumentation by K.R. Ferrell	1980
11.	Pressure and Flow Measurement by W. Wuest	1980
12.	Aircraft Flight Test Data Processing – A Review of the State of the Art by L.J. Smith and N.O. Matthews	1980
13.	Practical Aspects of Instrumentation System Installation by R.W. Borek	1981
14.	The Analysis of Random Data by D.A. Williams	1981
15.	Gyroscopic Instruments and Their Application to Flight Testing by B. Stieler and H. Winter	1982
16.	Trajectory Measurements for Take-off and Landing Test and Other Short-Range Applications by P. de Benque D'Agut, H. Riebeek and A. Pool	1985

17.	Analogue Signal Conditioning for Flight Test Instrumentation by D.W. Veatch and R.K. Bogue	1986
18.	Microprocessor Applications in Airborne Flight Test Instrumentation by M.J. Prickett	1987
19.	Digital Signal Conditioning for Flight Test by G.A. Bever	1991
20.	Optical Air Flow Measurements in Flight by R.K. Bogue and H.W. Jentink	2003
21.	Differential Global Positioning System (DGPS) for Flight Testing by R. Sabatini and G.B. Palmerini	2008
22.	Application of Fiber Optic Instrumentation by L. Richards, A.R. Parker, Jr., W.L. Ko, A. Piazza and P. Chan	2012

At the time of publication of the present volume, the following volumes are in preparation:

Reduced Friction Runway Surface Flight Testing (expected December 2015)

High Altitude Rotary Wing Flight Testing (expected December 2015)

## 2. Volumes in the AGARD and STO Flight Test Techniques Series, AGARDograph 300

Volume Number	Title	Publication Date
AG-237	Guide to In-Flight Thrust Measurement of Turbojets and Fan Engines by the MIDAP Study Group (UK)	1979
The remaining volumes are published as a sequence of Volume Numbers of AGARDograph 300.		
1.	Calibration of Air-Data Systems and Flow Direction Sensors by J.A. Lawford and K.R. Nippres	1983
2.	Identification of Dynamic Systems by R.E. Maine and K.W. Iliff	1985
3.	Identification of Dynamic Systems – Applications to Aircraft Part 1: The Output Error Approach by R.E. Maine and K.W. Iliff	1986
	Part 2: Nonlinear Analysis and Manoeuvre Design by J.A. Mulder, J.K. Sridhar and J.H. Breeman	1994
4.	Determination of Antenna Patterns and Radar Reflection Characteristics of Aircraft by H. Bothe and D. McDonald	1986
5.	Store Separation Flight Testing by R.J. Arnold and C.S. Epstein	1986
6.	Developmental Airdrop Testing Techniques and Devices by H.J. Hunter	1987
7.	Air-to-Air Radar Flight Testing by R.E. Scott	1988
8.	Flight Testing under Extreme Environmental Conditions by C.L. Henrickson	1988
9.	Aircraft Exterior Noise Measurement and Analysis Techniques by H. Heller	1991
10.	Weapon Delivery Analysis and Ballistic Flight Testing by R.J. Arnold and J.B. Knight	1992
11.	The Testing of Fixed Wing Tanker & Receiver Aircraft to Establish Their Air-to-Air Refuelling Capabilities by J. Bradley and K. Emerson	1992
12.	The Principles of Flight Test Assessment of Flight-Safety-Critical Systems in Helicopters by J.D.L. Gregory	1994
13.	Reliability and Maintainability by J.M. Howell	1995
14.	Introduction to Flight Test Engineering Issue 1: Edited by F. Stoliker	1995
	Issue 2: Edited by F. Stoliker and G. Bever	2005
15.	Introduction to Avionics Flight Test by J.M. Clifton	1996

16.	Introduction to Airborne Early Warning Radar Flight Test by J.M. Clifton and F.W. Lee	1999
17.	Electronic Warfare Test and Evaluation by H. Banks and R. McQuillan	2000
18.	Flight Testing of Radio Navigation Systems by H. Bothe and H.J. Hotop	2000
19.	Simulation in Support of Flight Testing by D. Hines	2000
20.	Logistics Test and Evaluation in Flight Testing by M. Bourcier	2001
21.	Flying Qualities Flight Testing of Digital Flight Control Systems by F. Webster and T.D. Smith	2001
22.	Helicopter/Ship Qualification Testing by D. Carico, R. Fang, R.S. Finch, W.P. Geyer Jr., Cdr. (Ret.) H.W. Krijns and K. Long	2003
23.	Flight Test Measurement Techniques for Laminar Flow by D. Fisher, K.H. Horstmann and H. Riedel	2003
24.	Precision Airdrop by M.R. Wuest and R.J. Benney	2005
25.	Flight Testing of Night Vision Systems in Rotorcraft by G. Craig, T. Macuda, S. Jennings, G. Ramphal and A. Stewart	2007 <sup>†</sup>
26.	Airborne Laser Systems Testing and Analysis by R. Sabatini and M.A. Richardson	2010
27.	Unique Aspects of Flight Testing Unmanned Aircraft Systems by A.E. Pontzer, M.D. Lower and J.R. Miller	2010
28.	Electronic Warfare Test and Evaluation by M. Welch and M. Pywell	2012
29.	Aircraft/Stores Compatibility, Integration and Separation Testing by O. Nadar	2014

At the time of publication of the present volume, the following volumes are in preparation:

Safety and Risk Management in Flight Testing (expected December 2014)

Application of IRIG 106 Digital Data Recorder Standards for Flight Test (expected December 2015)

---

<sup>†</sup> Volume 25 has been published as RTO AGARDograph AG-SCI-089.



<b>REPORT DOCUMENTATION PAGE</b>																	
<b>1. Recipient's Reference</b>	<b>2. Originator's References</b>	<b>3. Further Reference</b>	<b>4. Security Classification of Document</b>														
	STO-AG-300-V29 AC/323(SCI-244)TP/571	ISBN 978-92-837-0214-6	UNCLASSIFIED/ UNLIMITED														
<b>5. Originator</b>	Science and Technology Organization North Atlantic Treaty Organization BP 25, F-92201 Neuilly-sur-Seine Cedex, France																
<b>6. Title</b>	Aircraft/Stores Compatibility, Integration and Separation Testing																
<b>7. Presented at/Sponsored by</b>	The Systems Concepts and Integration Panel.																
<b>8. Author(s)/Editor(s)</b>	Multiple		<b>9. Date</b> September 2014														
<b>10. Author's/Editor's Address</b>	Multiple		<b>11. Pages</b> 186														
<b>12. Distribution Statement</b>	There are no restrictions on the distribution of this document. Information about the availability of this and other STO unclassified publications is given on the back cover.																
<b>13. Keywords/Descriptors</b>	<table style="width: 100%; border: none;"> <tr> <td style="width: 50%;">Airborne armament equipment</td> <td style="width: 50%;">Ground tests</td> </tr> <tr> <td>Aircraft/stores compatibility</td> <td>Integration</td> </tr> <tr> <td>Avionics integration</td> <td>Separation testing</td> </tr> <tr> <td>Carrier suitability testing</td> <td>System models</td> </tr> <tr> <td>Compatibility report</td> <td>Universal armaments interface</td> </tr> <tr> <td>Flight test instrumentation</td> <td>Weapon interface standards</td> </tr> <tr> <td>Flight tests</td> <td></td> </tr> </table>			Airborne armament equipment	Ground tests	Aircraft/stores compatibility	Integration	Avionics integration	Separation testing	Carrier suitability testing	System models	Compatibility report	Universal armaments interface	Flight test instrumentation	Weapon interface standards	Flight tests	
Airborne armament equipment	Ground tests																
Aircraft/stores compatibility	Integration																
Avionics integration	Separation testing																
Carrier suitability testing	System models																
Compatibility report	Universal armaments interface																
Flight test instrumentation	Weapon interface standards																
Flight tests																	
<b>14. Abstract</b>	<p>This AGARDograph focuses on aircraft/stores compatibility, integration and separation testing issues that have to be executed during the integration of existing/newly developed stores on to existing/new military aircraft.</p> <p>The integration of weapons on aircraft requires evaluation of multiple topics related to different disciplines such as aerodynamics, structures, avionics/software maintenance, electro-magnetic interactions, flight test instrumentation, ground and flight tests. In addition to compatibility concerns, the release of a weapon creates issues such as the ability of the specific store to achieve safe separation and the ability of the aircraft structure to withstand the imparted loads during the ejection of store from pylon or launching phase in the presence of aircraft flow field. The number of subjects to cover is increased when the requirements for all the phases of integration process are considered. The execution of integration activities in a correct and complete manner is the solution of these concerns.</p>																





BP 25  
F-92201 NEUILLY-SUR-SEINE CEDEX • FRANCE  
Télécopie 0(1)55.61.22.99 • E-mail [mailbox@cs0.nato.int](mailto:mailbox@cs0.nato.int)



**DIFFUSION DES PUBLICATIONS**  
**STO NON CLASSIFIEES**

Les publications de l'AGARD, de la RTO et de la STO peuvent parfois être obtenues auprès des centres nationaux de distribution indiqués ci-dessous. Si vous souhaitez recevoir toutes les publications de la STO, ou simplement celles qui concernent certains Panels, vous pouvez demander d'être inclus soit à titre personnel, soit au nom de votre organisation, sur la liste d'envoi.

Les publications de la STO, de la RTO et de l'AGARD sont également en vente auprès des agences de vente indiquées ci-dessous.

Les demandes de documents STO, RTO ou AGARD doivent comporter la dénomination « STO », « RTO » ou « AGARD » selon le cas, suivi du numéro de série. Des informations analogues, telles que le titre et la date de publication sont souhaitables.

Si vous souhaitez recevoir une notification électronique de la disponibilité des rapports de la STO au fur et à mesure de leur publication, vous pouvez consulter notre site Web (<http://www.sto.nato.int/>) et vous abonner à ce service.

### CENTRES DE DIFFUSION NATIONAUX

#### ALLEMAGNE

Streitkräfteamt / Abteilung III  
Fachinformationszentrum der Bundeswehr (FIZBw)  
Gorch-Fock-Straße 7, D-53229 Bonn

#### BELGIQUE

Royal High Institute for Defence – KHID/IRSD/RHID  
Management of Scientific & Technological Research  
for Defence, National STO Coordinator  
Royal Military Academy – Campus Renaissance  
Renaissancelaan 30, 1000 Bruxelles

#### CANADA

DSIGRD2 – Bibliothécaire des ressources du savoir  
R et D pour la défense Canada  
Ministère de la Défense nationale  
305, rue Rideau, 9e étage  
Ottawa, Ontario K1A 0K2

#### DANEMARK

Danish Acquisition and Logistics Organization  
(DALO)  
Lautrupbjerg 1-5  
2750 Ballerup

#### ESPAGNE

SDG TECIN / DGAM  
C/ Arturo Soria 289  
Madrid 28033

#### ESTONIE

Estonian Ministry of Defence  
Estonian National Coordinator for NATO STO  
Sakala 1  
Tallinn 15094

#### ETATS-UNIS

Defense Technical Information Center  
8725 John J. Kingman Road  
Fort Belvoir, VA 22060-6218

#### FRANCE

O.N.E.R.A. (ISP)  
29, Avenue de la Division Leclerc - BP 72  
92322 Châtillon Cedex

#### GRECE (Correspondant)

Defence Industry & Research General  
Directorate, Research Directorate  
Fakinos Base Camp, S.T.G. 1020  
Holargos, Athens

#### HONGRIE

Hungarian Ministry of Defence  
Development and Logistics Agency  
P.O.B. 25, H-1885 Budapest

#### ITALIE

Centro Gestione Conoscenza  
Secretariat General of Defence  
National Armaments Directorate  
Via XX Settembre 123/A  
00187 Roma

#### LUXEMBOURG

*Voir Belgique*

#### NORVEGE

Norwegian Defence Research  
Establishment, Attn: Biblioteket  
P.O. Box 25, NO-2007 Kjeller

#### PAYS-BAS

Royal Netherlands Military  
Academy Library  
P.O. Box 90.002  
4800 PA Breda

#### POLOGNE

Centralna Biblioteka Wojskowa  
ul. Ostrobramska 109  
04-041 Warszawa

#### PORTUGAL

Estado Maior da Força Aérea  
SDFA – Centro de Documentação  
Alfragide, P-2720 Amadora

#### REPUBLIQUE TCHEQUE

Vojenský technický ústav s.p.  
CZ Distribution Information Centre  
Mladoboleslavská 944  
PO Box 18  
197 06 Praha 9

#### ROUMANIE

Romanian National Distribution  
Centre  
Armaments Department  
9-11, Drumul Taberei Street  
Sector 6  
061353 Bucharest

#### ROYAUME-UNI

Dstl Knowledge and Information  
Services  
Building 247  
Porton Down, Salisbury SP4 0JQ

#### SLOVAQUIE

Akadémia ozbrojených síl gen.  
M.R. Štefánika, Distribučné a  
informačné stredisko STO  
Demánová 393  
031 06 Liptovský Mikuláš 6

#### SLOVENIE

Ministry of Defence  
Central Registry for EU & NATO  
Vojkova 55  
1000 Ljubljana

#### TURQUIE

Milli Savunma Bakanlıği (MSB)  
ARGE ve Teknoloji Dairesi  
Başkanlığı  
06650 Bakanlıklar – Ankara

### AGENCES DE VENTE

**The British Library Document  
Supply Centre**  
Boston Spa, Wetherby  
West Yorkshire LS23 7BQ  
ROYAUME-UNI

**Canada Institute for Scientific and  
Technical Information (CISTI)**  
National Research Council Acquisitions  
Montreal Road, Building M-55  
Ottawa K1A 0S2  
CANADA

Les demandes de documents STO, RTO ou AGARD doivent comporter la dénomination « STO », « RTO » ou « AGARD » selon le cas, suivie du numéro de série (par exemple AGARD-AG-315). Des informations analogues, telles que le titre et la date de publication sont souhaitables. Des références bibliographiques complètes ainsi que des résumés des publications STO, RTO et AGARD figurent dans le « NTIS Publications Database » (<http://www.ntis.gov>).



BP 25  
F-92201 NEUILLY-SUR-SEINE CEDEX • FRANCE  
Télécopie 0(1)55.61.22.99 • E-mail [mailbox@cs.o.nato.int](mailto:mailbox@cs.o.nato.int)



**DISTRIBUTION OF UNCLASSIFIED  
STO PUBLICATIONS**

AGARD, RTO & STO publications are sometimes available from the National Distribution Centres listed below. If you wish to receive all STO reports, or just those relating to one or more specific STO Panels, they may be willing to include you (or your Organisation) in their distribution.

STO, RTO and AGARD reports may also be purchased from the Sales Agencies listed below.

Requests for STO, RTO or AGARD documents should include the word 'STO', 'RTO' or 'AGARD', as appropriate, followed by the serial number. Collateral information such as title and publication date is desirable.

If you wish to receive electronic notification of STO reports as they are published, please visit our website (<http://www.sto.nato.int/>) from where you can register for this service.

### NATIONAL DISTRIBUTION CENTRES

#### BELGIUM

Royal High Institute for Defence – KHID/IRSD/RHID  
Management of Scientific & Technological Research  
for Defence, National STO Coordinator  
Royal Military Academy – Campus Renaissance  
Renaissancelaan 30  
1000 Brussels

#### CANADA

DRDKIM2 – Knowledge Resources Librarian  
Defence R&D Canada  
Department of National Defence  
305 Rideau Street, 9<sup>th</sup> Floor  
Ottawa, Ontario K1A 0K2

#### CZECH REPUBLIC

Vojenský technický ústav s.p.  
CZ Distribution Information Centre  
Mladoboleslavská 944  
PO Box 18  
197 06 Praha 9

#### DENMARK

Danish Acquisition and Logistics Organization (DALO)  
Lautrupbjerg 1-5  
2750 Ballerup

#### ESTONIA

Estonian Ministry of Defence  
Estonian National Coordinator for NATO STO  
Sakala 1, Tallinn 15094

#### FRANCE

O.N.E.R.A. (ISP)  
29, Avenue de la Division Leclerc - BP 72  
92322 Châtillon Cedex

#### GERMANY

Streitkräfteamt / Abteilung III  
Fachinformationszentrum der Bundeswehr (FIZBw)  
Gorch-Fock-Straße 7  
D-53229 Bonn

#### GRECE (Point of Contact)

Defence Industry & Research General  
Directorate, Research Directorate  
Fakinos Base Camp, S.T.G. 1020  
Holargos, Athens

#### HUNGARY

Hungarian Ministry of Defence  
Development and Logistics Agency  
P.O.B. 25, H-1885 Budapest

#### ITALY

Centro Gestione Conoscenza  
Secretariat General of Defence  
National Armaments Directorate  
Via XX Settembre 123/A, 00187 Roma

#### LUXEMBOURG

See Belgium

#### NETHERLANDS

Royal Netherlands Military  
Academy Library  
P.O. Box 90.002  
4800 PA Breda

#### NORWAY

Norwegian Defence Research  
Establishment, Attn: Biblioteket  
P.O. Box 25, NO-2007 Kjeller

#### POLAND

Centralna Biblioteka Wojskowa  
ul. Ostrobramska 109  
04-041 Warszawa

#### PORTUGAL

Estado Maior da Força Aérea  
SDFA – Centro de Documentação  
Alfragide, P-2720 Amadora

#### ROMANIA

Romanian National Distribution  
Centre  
Armaments Department  
9-11, Drumul Taberei Street  
Sector 6, 061353 Bucharest

#### SLOVAKIA

Akadémia ozbrojených síl gen  
M.R. Štefánika, Distribučné a  
informačné stredisko STO  
Demänová 393  
031 06 Liptovský Mikuláš 6

#### SLOVENIA

Ministry of Defence  
Central Registry for EU & NATO  
Vojkova 55  
1000 Ljubljana

#### SPAIN

SDG TECIN / DGAM  
C/ Arturo Soria 289  
Madrid 28033

#### TURKEY

Milli Savunma Bakanlığı (MSB)  
ARGE ve Teknoloji Dairesi  
Başkanlığı  
06650 Bakanlıklar – Ankara

#### UNITED KINGDOM

Dstl Knowledge and Information  
Services  
Building 247  
Porton Down, Salisbury SP4 0JQ

#### UNITED STATES

Defense Technical Information  
Center  
8725 John J. Kingman Road  
Fort Belvoir, VA 22060-6218

### SALES AGENCIES

**The British Library Document  
Supply Centre**  
Boston Spa, Wetherby  
West Yorkshire LS23 7BQ  
UNITED KINGDOM

**Canada Institute for Scientific and  
Technical Information (CISTI)**  
National Research Council Acquisitions  
Montreal Road, Building M-55  
Ottawa K1A 0S2  
CANADA

Requests for STO, RTO or AGARD documents should include the word 'STO', 'RTO' or 'AGARD', as appropriate, followed by the serial number (for example AGARD-AG-315). Collateral information such as title and publication date is desirable. Full bibliographical references and abstracts of STO, RTO and AGARD publications are given in "NTIS Publications Database" (<http://www.ntis.gov>).